

Transistors

BC237

SWITCHING AND AMPLIFIER APPLICATIONS

ABSOLUTE MAXIMUM RATINGS ($T_a = 25^\circ\text{C}$)

Characteristic	Symbol	Rating	Unit
Collector-Emitter Voltage	V_{CES}	50	V
Collector-Emitter Voltage	V_{CEO}	45	V
Emitter-Base Voltage	V_{EBO}	6	V
Collector Current (DC)	I_C	100	mA
Collector Dissipation	P_C	500	mW
Junction Temperature	T_j	150	$^\circ\text{C}$
Storage Temperature	T_{stg}	-55~150	$^\circ\text{C}$

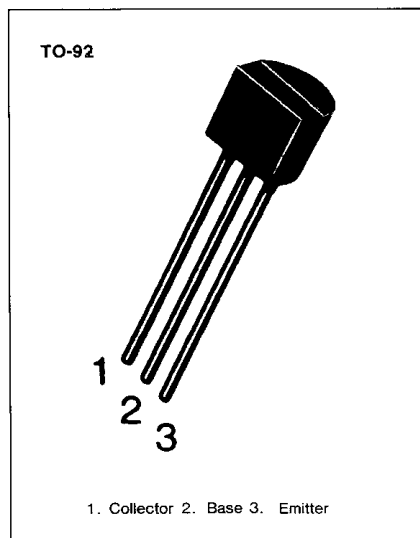

ELECTRICAL CHARACTERISTICS ($T_a = 25^\circ\text{C}$)

Characteristic	Symbol	Test Condition	Min	Typ	Max	Unit
Collector Emitter Breakdown Voltage	BV_{CEO}	$I_C = 2\text{mA}, I_B = 0$	45			V
Emitter Base Breakdown Voltage	BV_{EBO}	$I_E = 1\mu\text{A}, I_C = 0$	6			V
Collector Cutoff Current	I_{CES}	$V_{CE} = 50\text{V}, I_B = 0$		0.2	15	nA
DC Current Gain	h_{FE}	$V_{CE} = 5\text{V}, I_C = 2\text{mA}$	120		800	
Collector Emitter Saturation Voltage	$V_{CE(sat)}$	$I_C = 10\text{mA}, I_B = 0.5\text{mA}$		0.07	0.2	V
		$I_C = 100\text{mA}, I_B = 5\text{mA}$		0.2	0.6	V
Collector Base Saturation Voltage	$V_{BE(sat)}$	$I_C = 10\text{mA}, I_B = 0.5\text{mA}$		0.73	0.83	V
		$I_C = 100\text{mA}, I_B = 5\text{mA}$		0.87	1.05	V
Base Emitter On Voltage	$V_{BE(on)}$	$V_{CE} = 5\text{V}, I_C = 2\text{mA}$	0.55	0.62	0.7	V
Current Gain Bandwidth Product	f_T	$V_{CE} = 3\text{V}, I_C = 0.5\text{mA}$		85		MHz
		$V_{CE} = 5\text{V}, I_C = 10\text{mA}$	150	250		MHz
Collector Base Capacitance	C_{CBO}	$V_{CB} = 10\text{V}, f = 1\text{MHz}$		3.5	6	pF
Emitter Base Capacitance	C_{EBO}	$V_{EB} = 0.5\text{V}, f = 1\text{MHz}$		8		pF
Noise Figure	NF	$V_{CE} = 5\text{V}, I_C = 0.2\text{mA}, f = 1\text{KHz}, R_g = 2\text{kohm}$		2	10	dB

h_{FE} CLASSIFICATION

Classification	A	B	C
h_{FE}	120-220	180-460	380-800

