



Micro Commercial Components  
 21201 Itasca Street Chatsworth  
 CA 91311  
 Phone: (818) 701-4933  
 Fax: (818) 701-4939

# 1N4942GP THRU 1N4948GP

## 1 Amp Glass Passivated Fast Recovery Rectifier 200 - 1000 Volts

### Features

- Low Leakage Current
- Metalurgically Bonded Construction
- Low Cost
- Fast Switching For High Efficiency
- Glass Passivated Junction

### Maximum Ratings

- Operating Temperature: -55°C to +150°C
- Storage Temperature: -55°C to +150°C
- Maximum Thermal Resistance; 50°C/W Junction To Ambient

Microsemi Catalog Number	Device Marking	Maximum Recurrent Peak Reverse Voltage	Maximum RMS Voltage	Maximum DC Blocking Voltage
1N4942GP	---	200V	140V	200V
1N4944GP	---	400V	280V	400V
1N4946GP	---	600V	420V	600V
1N4947GP	---	800V	560V	800V
1N4948GP	---	1000V	700V	1000V

### Electrical Characteristics @ 25°C Unless Otherwise Specified

Average Forward Current	$I_{F(AV)}$	1.0A	$T_A = 55^\circ\text{C}$
Peak Forward Surge Current	$I_{FSM}$	25A	8.3ms, half sine
Maximum Instantaneous Forward Voltage	$V_F$	1.3V	$I_{FM} = 1.0\text{A}; T_A = 25^\circ\text{C}^*$
Maximum DC Reverse Current At Rated DC Blocking Voltage	$I_R$	5.0 $\mu\text{A}$ 200 $\mu\text{A}$	$T_J = 25^\circ\text{C}$ $T_J = 150^\circ\text{C}$
Maximum Reverse Recovery Time 1N4942-4944 1N4946-4947 1N4948	$T_{rr}$	150ns 250ns 500ns	$I_F=0.5\text{A},$ $I_R=1.0\text{A},$ $I_{rr}=0.25\text{A}$
Typical Junction Capacitance	$C_J$	15pF	Measured at 1.0MHz, $V_R=4.0\text{V}$

\*Pulse test: Pulse width 300  $\mu\text{sec}$ , Duty cycle 2%

### DO-41

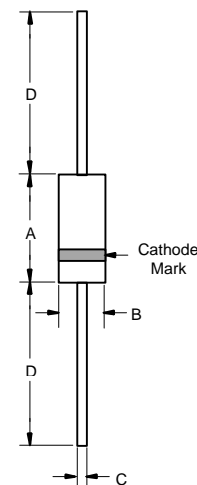

DIM	INCHES		MM		NOTE
	MIN	MAX	MIN	MAX	
A	.166	.205	4.10	5.20	
B	.080	.107	2.00	2.70	
C	.028	.034	.70	.90	
D	1.000	---	25.40	---	

# 1N4942GP thru 1N4948GP

Figure 1  
Typical Forward Characteristics

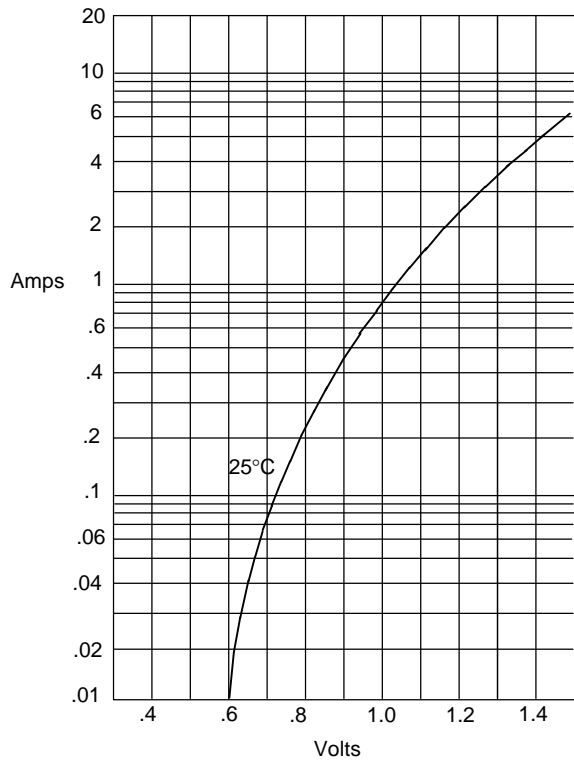

Instantaneous Forward Current - Amperes *versus*  
Instantaneous Forward Voltage - Volts

Figure 2  
Forward Derating Curve

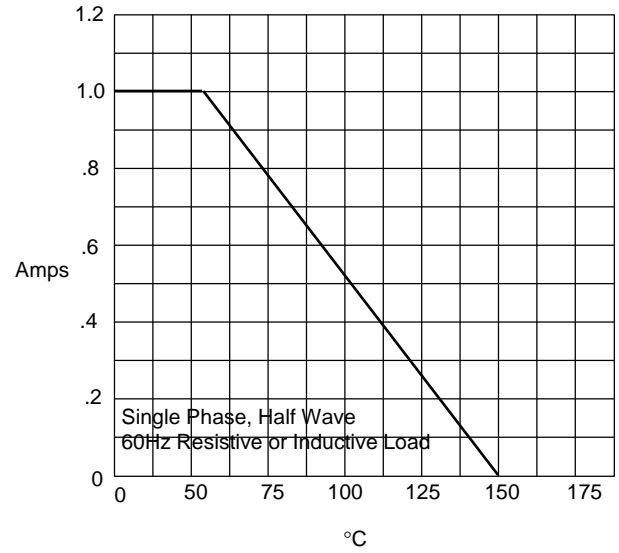

Average Forward Rectified Current - Amperes *versus*  
Ambient Temperature - °C

Figure 3  
Junction Capacitance

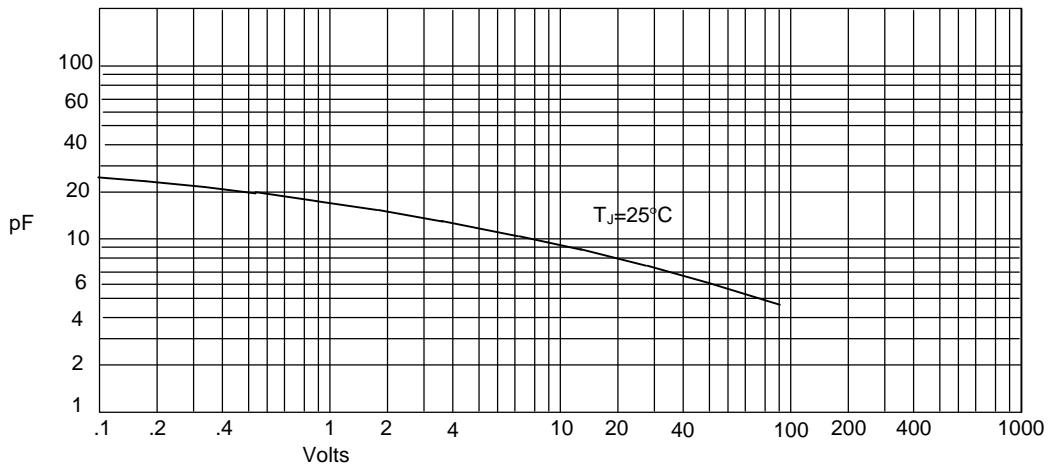

Junction Capacitance - pF *versus*  
Reverse Voltage - Volts

# 1N4942GP thru 1N4948GP

Figure 4  
Typical Reverse Characteristics

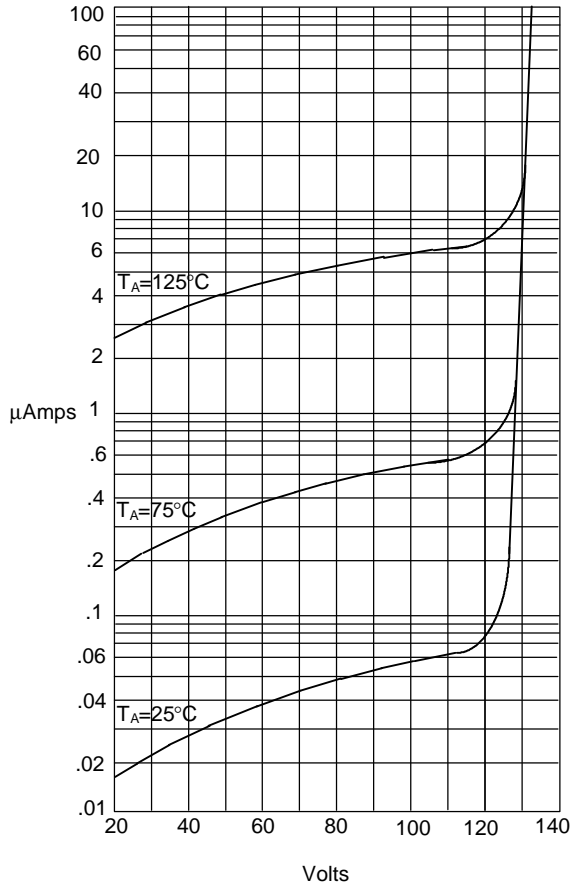

Instantaneous Reverse Leakage Current - MicroAmperes versus  
Percent Of Rated Peak Reverse Voltage - Volts

Figure 5  
Non-Repetitive Peak Forward Surge Current

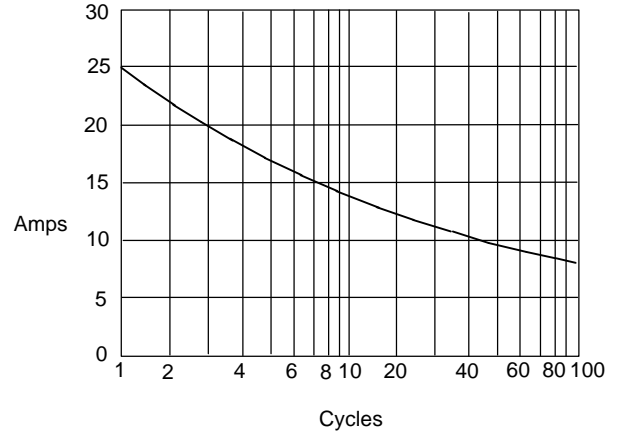

Peak Forward Surge Current - Amperes versus  
Number Of Cycles At 60Hz - Cycles

Figure 6  
Reverse Recovery Time Characteristic And Test Circuit Diagram

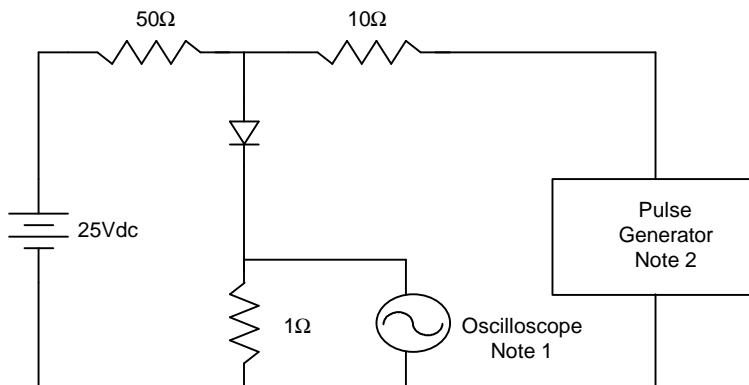

- Notes:
1. Rise Time = 7ns max.  
Input impedance = 1 megohm, 22pF
  2. Rise Time = 10ns max.  
Source impedance = 50 ohms
  3. Resistors are non-inductive

