



Micro Commercial Components  
 21201 Itasca Street Chatsworth  
 CA 91311  
 Phone: (818) 701-4933  
 Fax: (818) 701-4939

# DL4933 THRU DL4937

## Features

- Glass Passivated Junction
- Low Leakage Current
- Metalurgically Bonded Construction
- Surface Mount Applications
- Fast Switching

## Maximum Ratings

- Operating Temperature: -55°C to +150°C
- Storage Temperature: -55°C to +150°C
- Maximum Thermal Resistance; 30°C/W Junction To Lead

MCC Catalog Number	Device Marking	Maximum Recurrent Peak Reverse Voltage	Maximum RMS Voltage	Maximum DC Blocking Voltage
DL4933	---	50V	35V	50V
DL4934	---	100V	70V	100V
DL4935	---	200V	140V	200V
DL4936	---	400V	280V	400V
DL4937	---	600V	420V	600V

## 1 Amp Glass Passivated, Fast Recovery Rectifier 50 to 600 Volts

### MELF

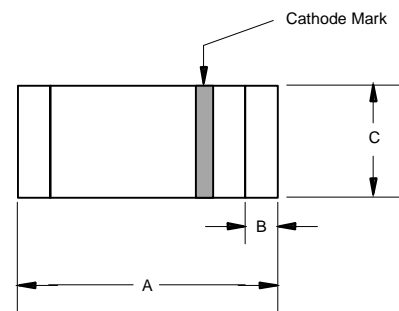

DIM	INCHES		MM		NOTE
	MIN	MAX	MIN	MAX	
A	.190	.205	4.80	5.20	
B	---	.022	---	.55	Nominal
C	.095	.105	2.40	2.67	∅

## Electrical Characteristics @ 25°C Unless Otherwise Specified

Average Forward Current	$I_{F(AV)}$	1.0A	$T_A = 55^\circ\text{C}$
Peak Forward Surge Current	$I_{FSM}$	30A	8.3ms, half sine
Maximum Instantaneous Forward Voltage	$V_F$	1.3V	$I_{FM} = 1.0\text{A}; T_J = 25^\circ\text{C}$
Maximum DC Reverse Current At Rated DC Blocking Voltage	$I_R$	5.0 $\mu\text{A}$ 100 $\mu\text{A}$	$T_J = 25^\circ\text{C}$ $T_J = 125^\circ\text{C}$
Maximum Reverse Recovery Time	$T_{rr}$	150ns	$I_F = 0.5\text{A}, I_R = 1.0\text{A}, I_{rr} = 0.25\text{A}$
Typical Junction Capacitance	$C_J$	15pF	Measured at 1.0MHz, $V_R = 4.0\text{V}$

### SUGGESTED SOLDER PAD LAYOUT

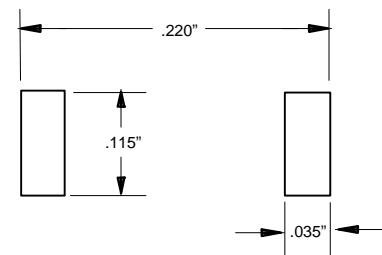

\*Pulse test: Pulse width 300  $\mu\text{sec}$ , Duty cycle 1%

Figure 1  
Typical Forward Characteristics

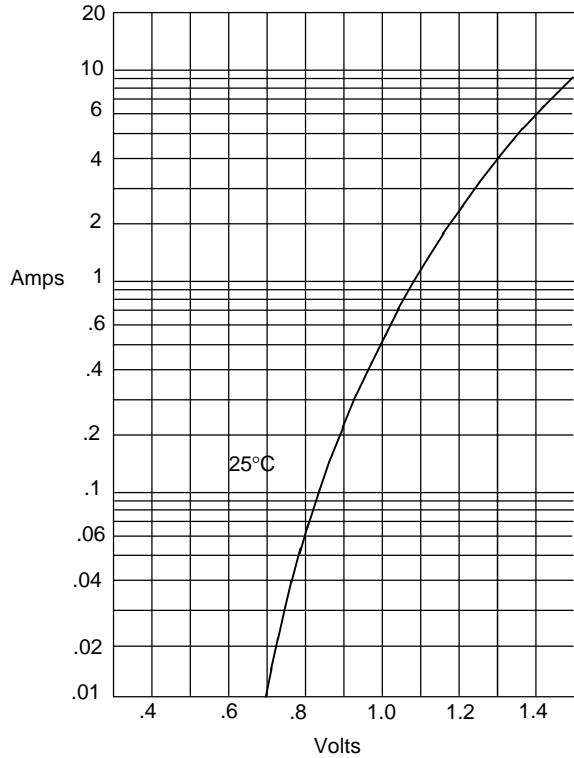

Instantaneous Forward Current - Amperes *versus*  
Instantaneous Forward Voltage - Volts

Figure 2  
Forward Derating Curve

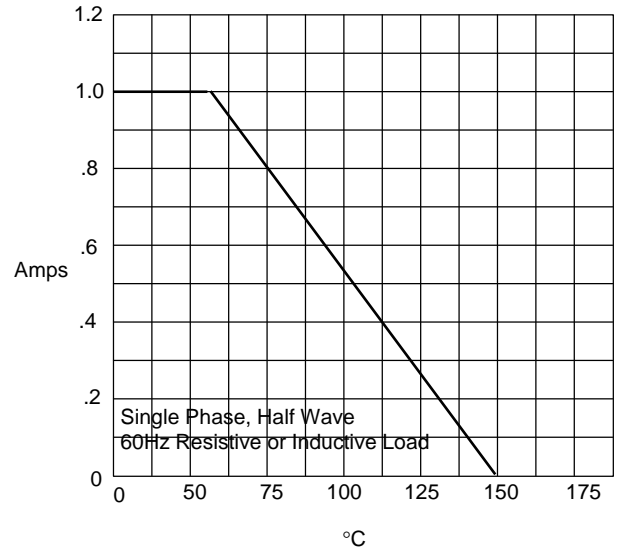

Average Forward Rectified Current - Amperes *versus*  
Ambient Temperature - °C

Figure 3  
Junction Capacitance

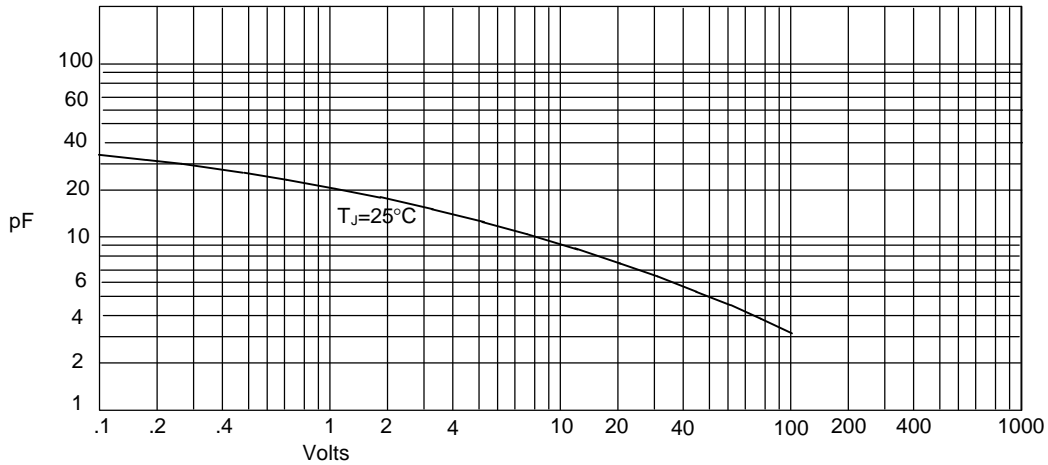

Junction Capacitance - pF *versus*  
Reverse Voltage - Volts

Figure 4  
Typical Reverse Characteristics

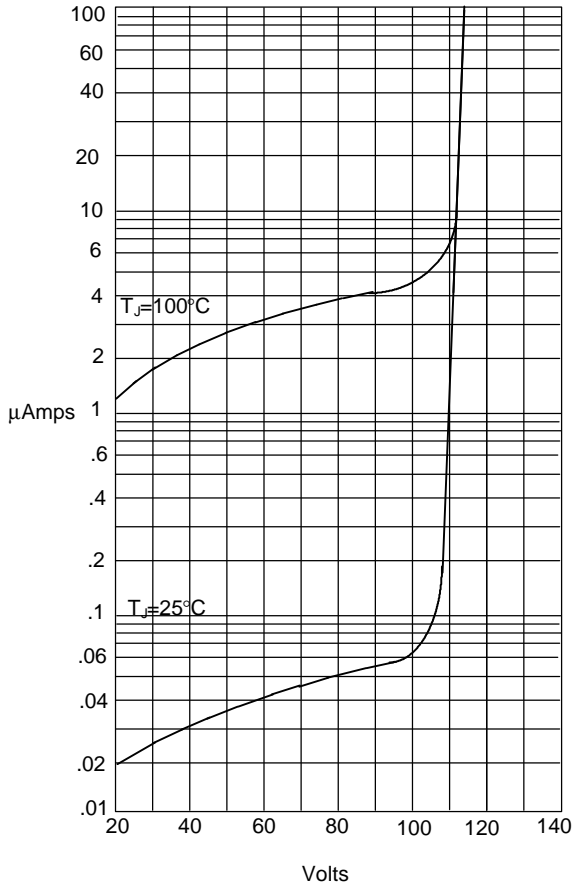

Instantaneous Reverse Leakage Current - MicroAmperes versus  
Percent Of Rated Peak Reverse Voltage - Volts

Figure 5  
Peak Forward Surge Current

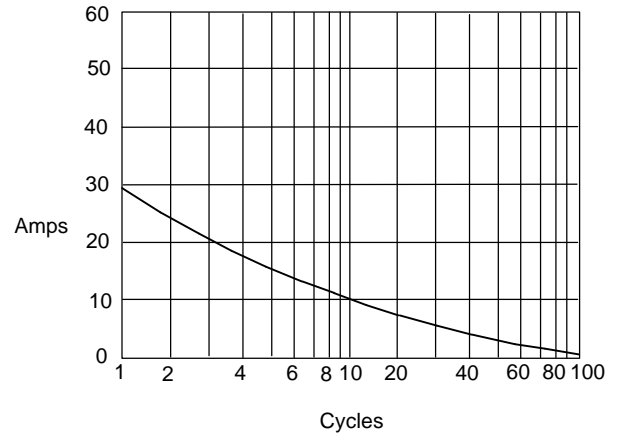

Peak Forward Surge Current - Amperes versus  
Number Of Cycles At 60Hz - Cycles

Figure 6  
Reverse Recovery Time Characteristic And Test Circuit Diagram

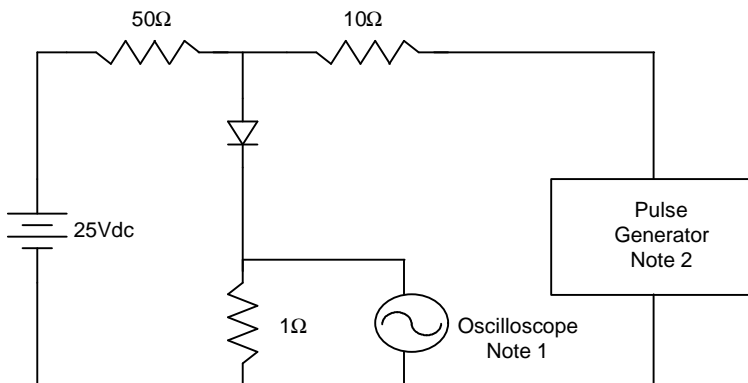

- Notes:
1. Rise Time = 7ns max.  
Input impedance = 1 megohm, 22pF
  2. Rise Time = 10ns max.  
Source impedance = 50 ohms
  3. Resistors are non-inductive

