



Micro Commercial Components  
 21201 Itasca Street Chatsworth  
 CA 91311  
 Phone: (818) 701-4933  
 Fax: (818) 701-4939

# UF5400 THRU UF5408

## Features

- High Surge Capability
- Low Leakage
- Low Forward Voltage Drop
- Ultra Fast Switching Speed For High Efficiency

## Maximum Ratings

- Operating Temperature: -55°C to +150°C
- Storage Temperature: -55°C to +150°C
- Typical Thermal Resistance 20°C/W

MCC Catalog Number	Device Marking	Maximum Recurrent Peak Reverse Voltage	Maximum RMS Voltage	Maximum DC Blocking Voltage
UF5400	---	50V	35V	50V
UF5401	---	100V	70V	100V
UF5402	---	200V	140V	200V
UF5404	---	400V	280V	400V
UF5406	---	600V	420V	400V
UF5407	---	800V	560V	800V
UF5408	---	1000V	700V	1000V

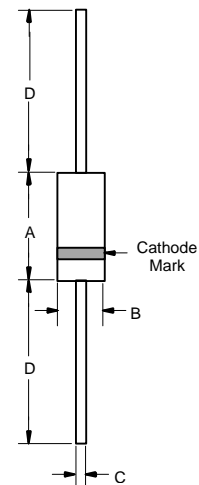
## Electrical Characteristics @ 25°C Unless Otherwise Specified

Average Forward Current	$I_{F(AV)}$	3 A	$T_A = 55^\circ\text{C}$
Peak Forward Surge Current	$I_{FSM}$	150A	8.3ms, half sine
Maximum Instantaneous Forward Voltage UF5400-5402 UF5404 UF5406-UF5408	$V_F$	1.0V 1.3V 1.7V	$I_{FM} = 3.0\text{A};$ $T_A = 25^\circ\text{C}$
Reverse Current At Rated DC Blocking Voltage (Maximum DC)	$I_R$	10 $\mu\text{A}$ 50 $\mu\text{A}$	$T_A = 25^\circ\text{C}$ $T_A = 100^\circ\text{C}$
Maximum Reverse Recovery Time UF5400-5404 UF5406-5408	$T_{rr}$	50ns 75ns	$I_F=0.5\text{A}, I_R=1.0\text{A},$ $I_{rr}=0.25\text{A}$
Typical Junction Capacitance UF5400-5404 UF5406-5408	$C_J$	75pF 50pF	Measured at 1.0MHz, $V_R=4.0\text{V}$

\*Pulse Test: Pulse Width 300 $\mu\text{sec}$ , Duty Cycle 1%

## 3 Amp Ultra Fast Recovery Rectifier 50 to 1000 Volts

### DO-201AD

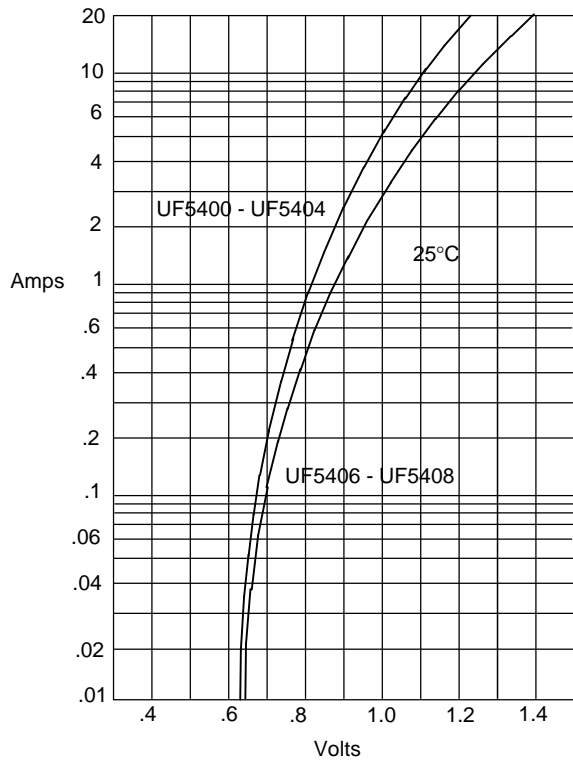


DIM	DIMENSIONS				NOTE
	INCHES		MM		
A	---	.370	---	9.50	
B	---	.250	---	6.40	
C	.048	.052	1.20	1.30	
D	1.000	---	25.40	---	

# UF5400 thru UF5408

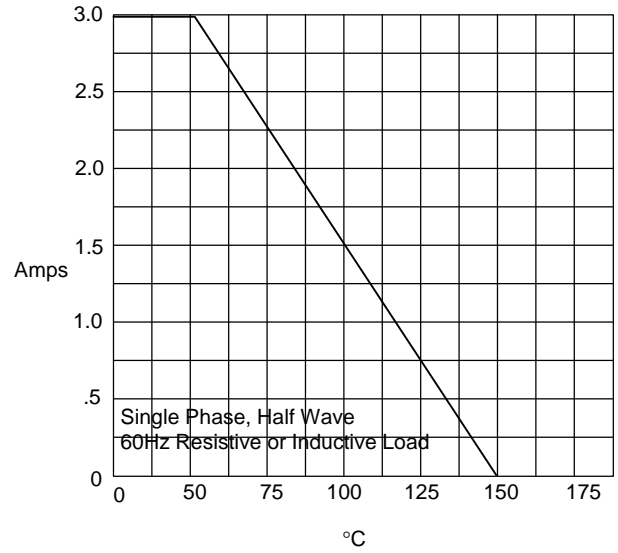


Figure 1  
Typical Forward Characteristics



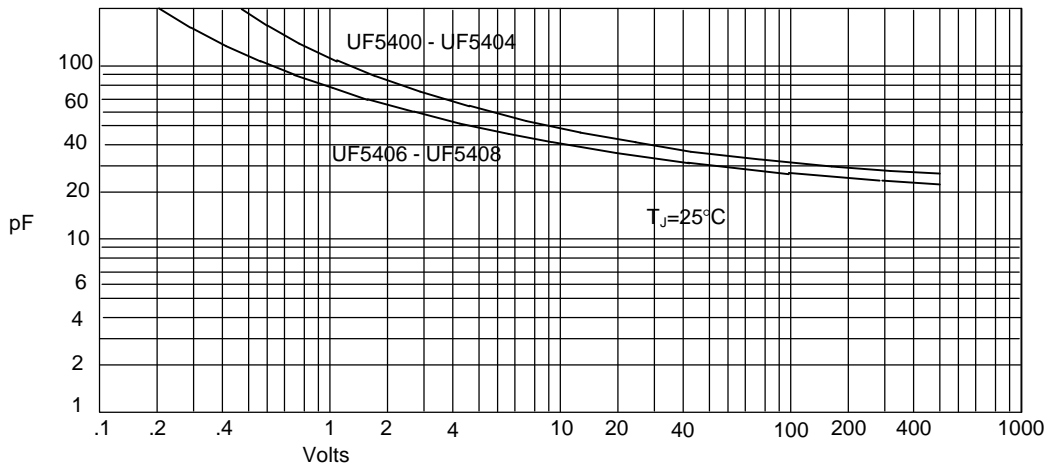
Instantaneous Forward Current - Amperes *versus*  
Instantaneous Forward Voltage - Volts

Figure 2  
Forward Derating Curve



Average Forward Rectified Current - Amperes *versus*  
Ambient Temperature - °C

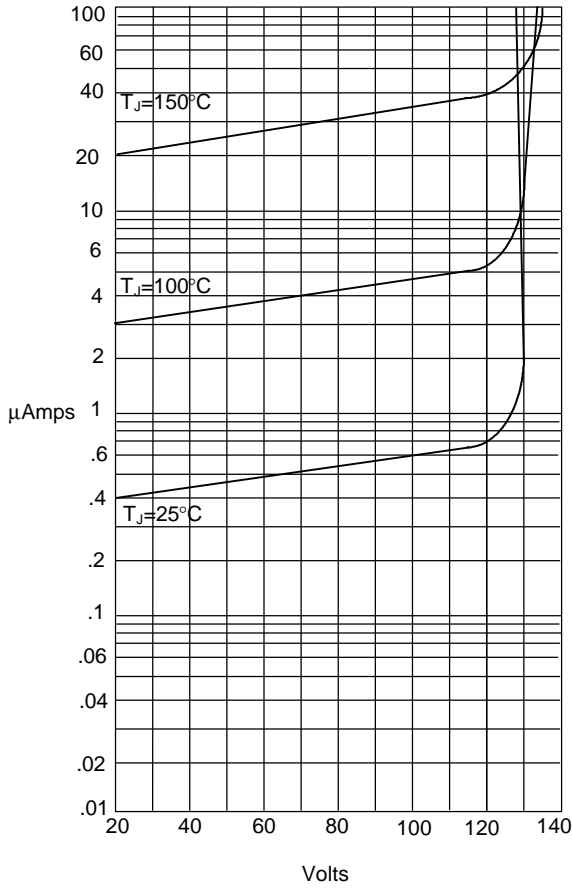
Figure 3  
Junction Capacitance



Junction Capacitance - pF *versus*  
Reverse Voltage - Volts

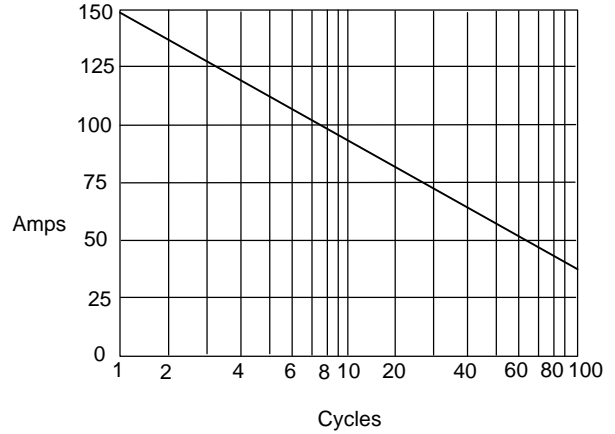
UF5400 thru UF5408

Figure 4  
Typical Reverse Characteristics



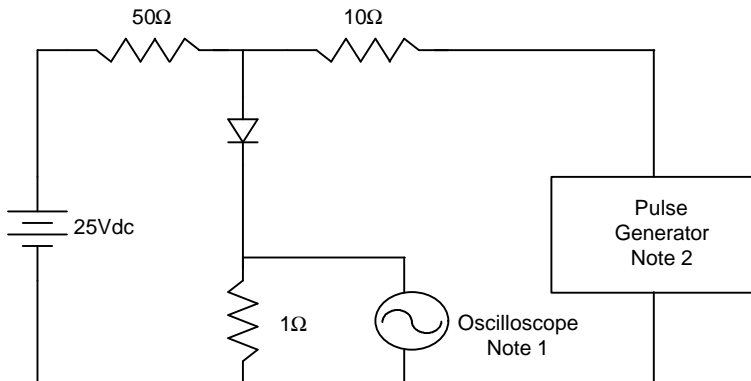
Instantaneous Reverse Leakage Current - MicroAmperes versus  
Percent Of Rated Peak Reverse Voltage - Volts

Figure 5  
Peak Forward Surge Current



Peak Forward Surge Current - Amperes versus  
Number Of Cycles At 60Hz - Cycles

Figure 6  
Reverse Recovery Time Characteristic And Test Circuit Diagram



- Notes:
1. Rise Time = 7ns max.  
Input impedance = 1 megohm, 22pF
  2. Rise Time = 10ns max.  
Source impedance = 50 ohms
  3. Resistors are non-inductive

