

DATA SHEET

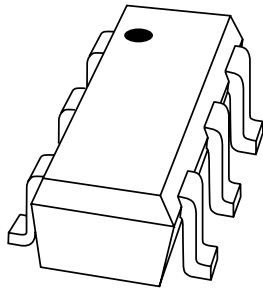

BAW101S High voltage double diode

Product specification

2003 May 13

High voltage double diode

BAW101S

FEATURES

- Small plastic SMD package
- High switching speed: max. 50 ns
- High continuous reverse voltage: 300 V
- Electrically insulated diodes.

APPLICATIONS

- High voltage switching
- Automotive
- Communication.

DESCRIPTION

The BAW101S is a high-speed switching diode array with two separate dice, fabricated in planar technology and encapsulated in a small SOT363 plastic SMD package.

MARKING

TYPE NUMBER	MARKING CODE ⁽¹⁾
BAW101S	K2*

Note

- * = p: Made in Hong Kong.
 * = t: Made in Malaysia.
 * = W: Made in China.

PINNING

PIN	DESCRIPTION
1	anode 1
2	n.c.
3	cathode 2
4	anode 2
5	n.c.
6	cathode 1

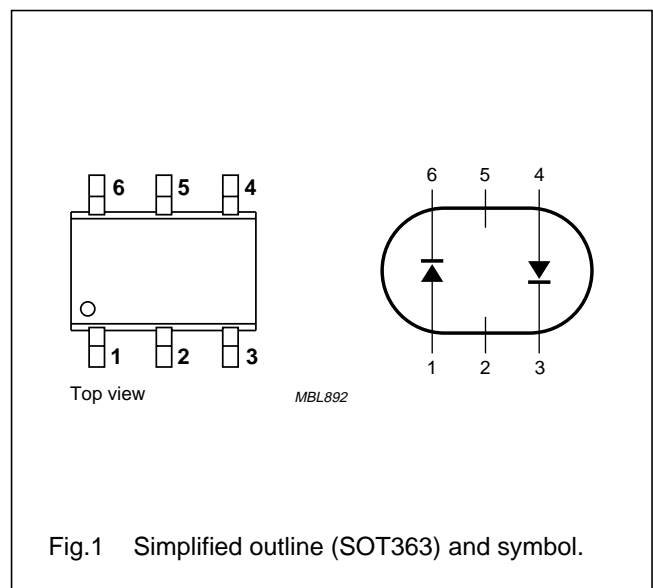

Fig.1 Simplified outline (SOT363) and symbol.

High voltage double diode

BAW101S

LIMITING VALUES

In accordance with the Absolute Maximum Rating System (IEC 60134).

SYMBOL	PARAMETER	CONDITIONS	MIN.	MAX.	UNIT
Per diode					
V_R	continuous reverse voltage		–	300	V
		series connection	–	600	V
V_{RRM}	repetitive peak reverse voltage		–	300	V
		series connection	–	600	V
I_F	continuous forward current	single diode loaded; note 1; see Fig.2	–	250	mA
		double diode loaded; note 1; see Fig.2	–	140	mA
I_{FRM}	repetitive peak forward current		–	625	mA
I_{FSM}	non-repetitive peak forward current	square wave; $T_j = 25\text{ °C}$ prior to surge; $t = 1\text{ }\mu\text{s}$	–	4.5	A
P_{tot}	total power dissipation	$T_{amb} = 25\text{ °C}$; note 1	–	350	mW
T_{stg}	storage temperature		–65	+150	°C
T_j	junction temperature		–	150	°C
T_{amb}	operating ambient temperature		–65	+150	°C

Note

1. Device mounted on an FR4 printed-circuit board, cathode-lead mounting pad = 1 cm².

ELECTRICAL CHARACTERISTICS $T_j = 25\text{ °C}$ unless otherwise specified.

SYMBOL	PARAMETER	CONDITIONS	MIN.	MAX.	UNIT
Per diode					
$V_{BR(R)}$	reverse breakdown voltage	$I_R = 100\text{ }\mu\text{A}$	300	–	V
V_F	forward voltage	$I_F = 100\text{ mA}$; note 1	–	1.1	V
I_R	reverse current	$V_R = 250\text{ V}$	–	150	nA
		$V_R = 250\text{ V}$; $T_{amb} = 150\text{ °C}$	–	50	μA
t_{rr}	reverse recovery time	when switched from $I_F = 30\text{ mA}$ to $I_R = 30\text{ mA}$; $R_L = 100\text{ }\Omega$; measured at $I_R = 3\text{ mA}$	–	50	ns
C_d	diode capacitance	$V_R = 0\text{ V}$; $f = 1\text{ MHz}$	–	2	pF

Note

1. Pulse test: pulse width = 300 μs ; $\delta = 0.02$.

High voltage double diode

BAW101S

THERMAL CHARACTERISTICS

SYMBOL	PARAMETER	CONDITIONS	VALUE	UNIT
$R_{th\ j-s}$	thermal resistance from junction to soldering point	note 1	255	K/W
$R_{th\ j-a}$	thermal resistance from junction to ambient	note 2	357	K/W

Notes

- One or more diodes loaded.
- Device mounted on an FR4 printed-circuit board, cathode-lead mounting pad = 1 cm².

GRAPHICAL DATA

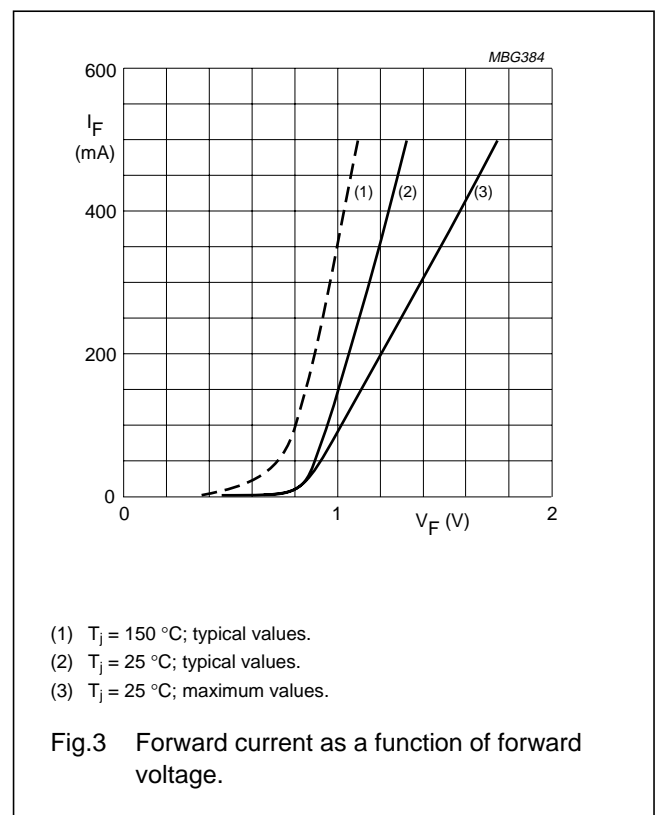
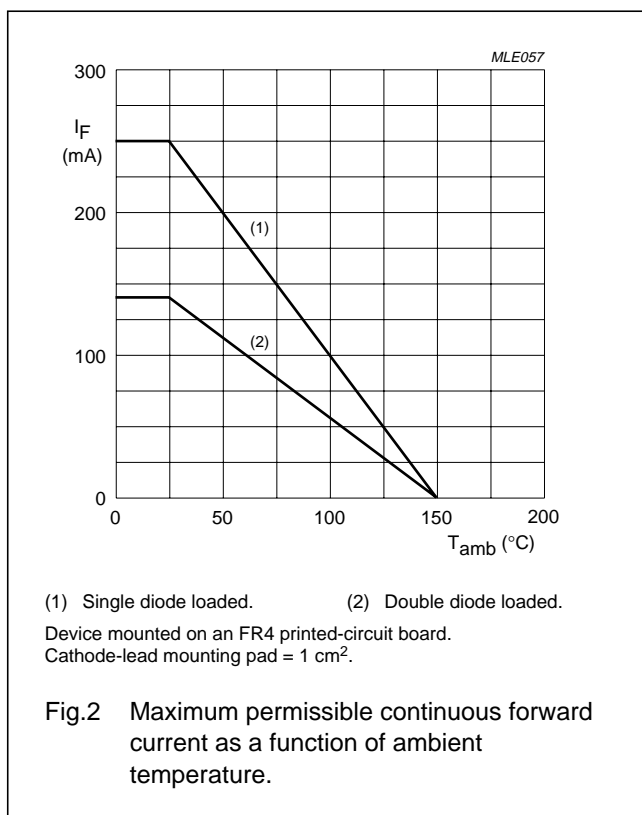

High voltage double diode

BAW101S

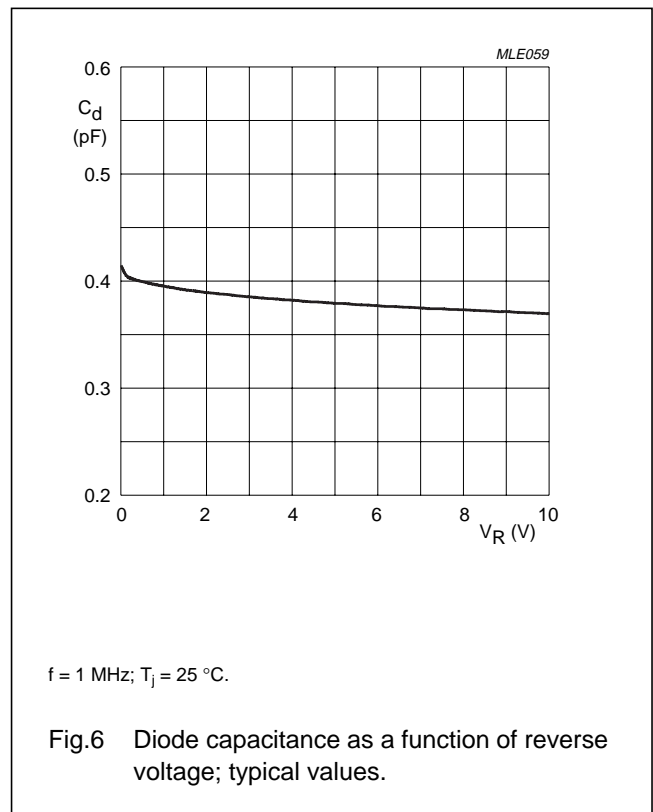
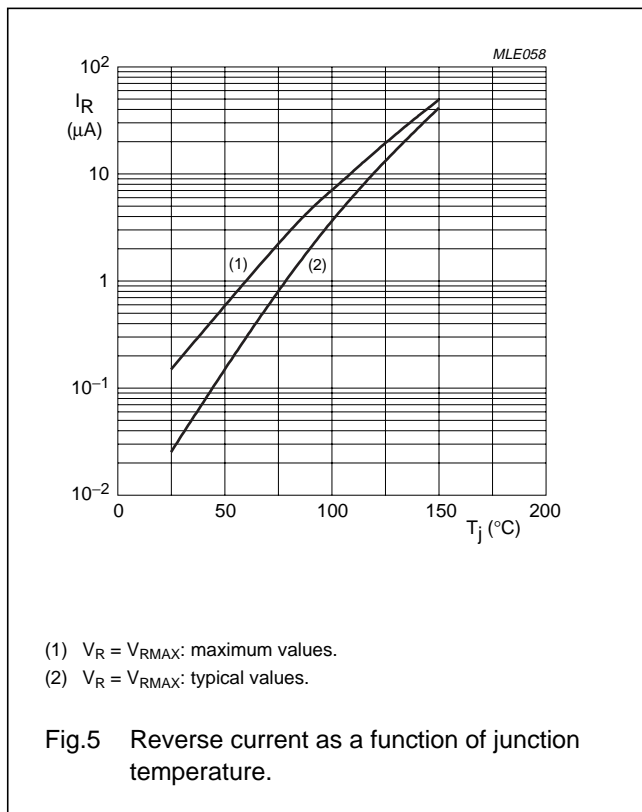
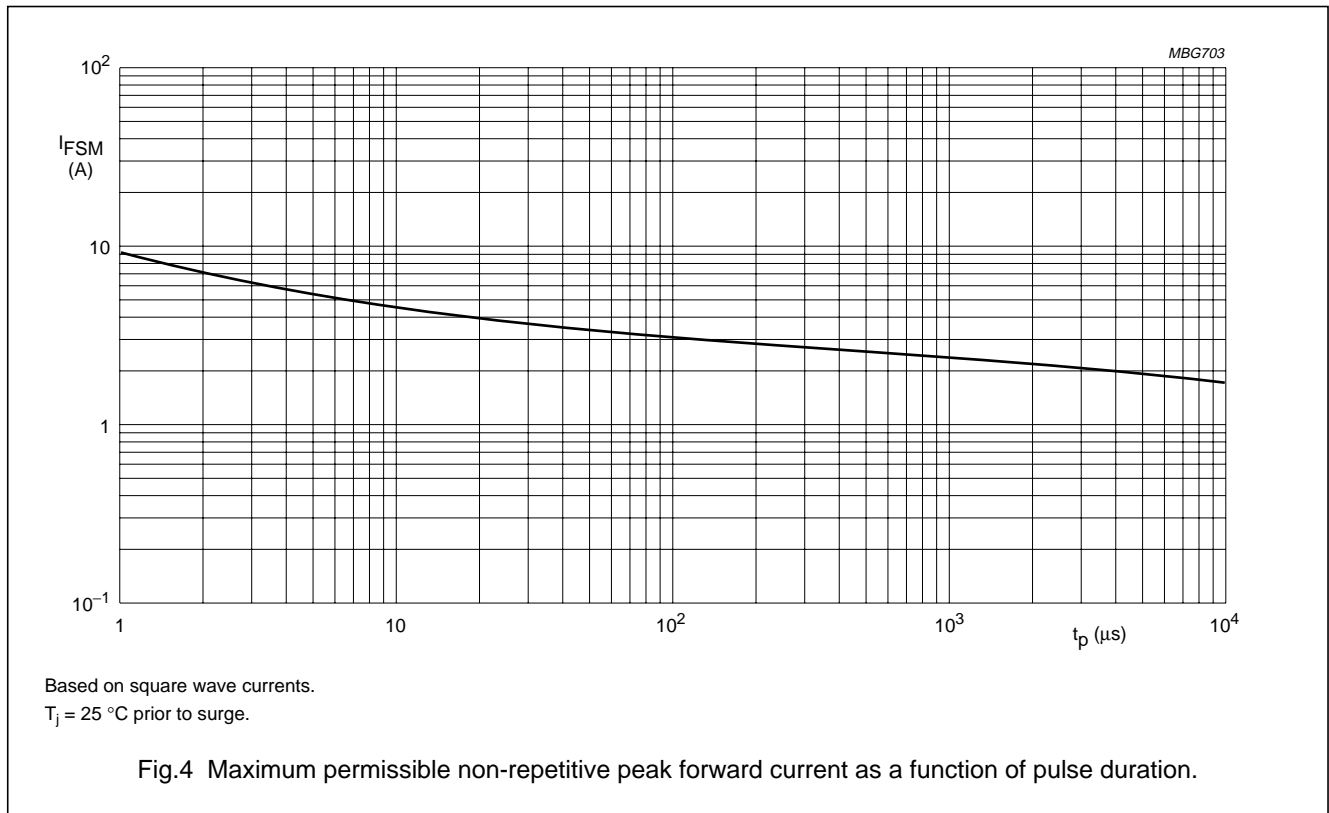

High voltage double diode

BAW101S

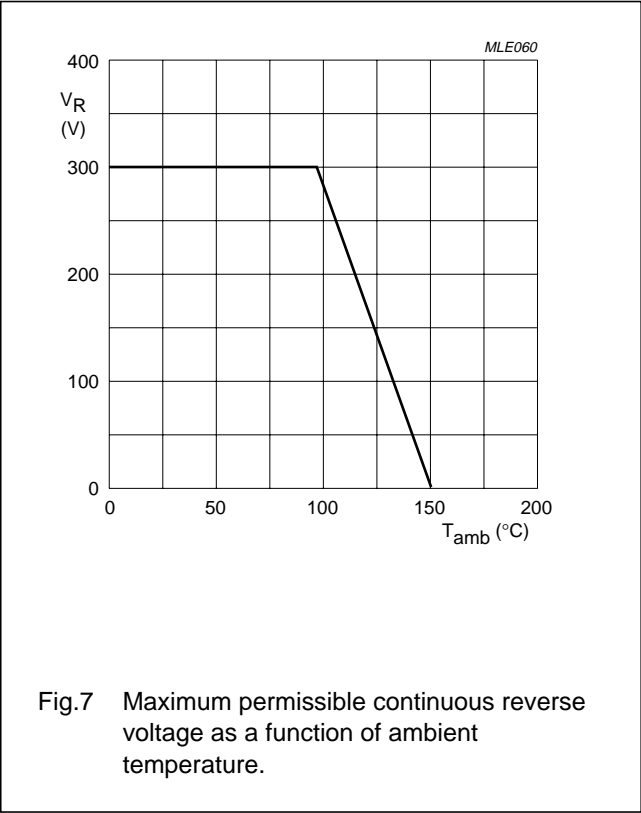

High voltage double diode

BAW101S

PACKAGE OUTLINE

Plastic surface mounted package; 6 leads

SOT363

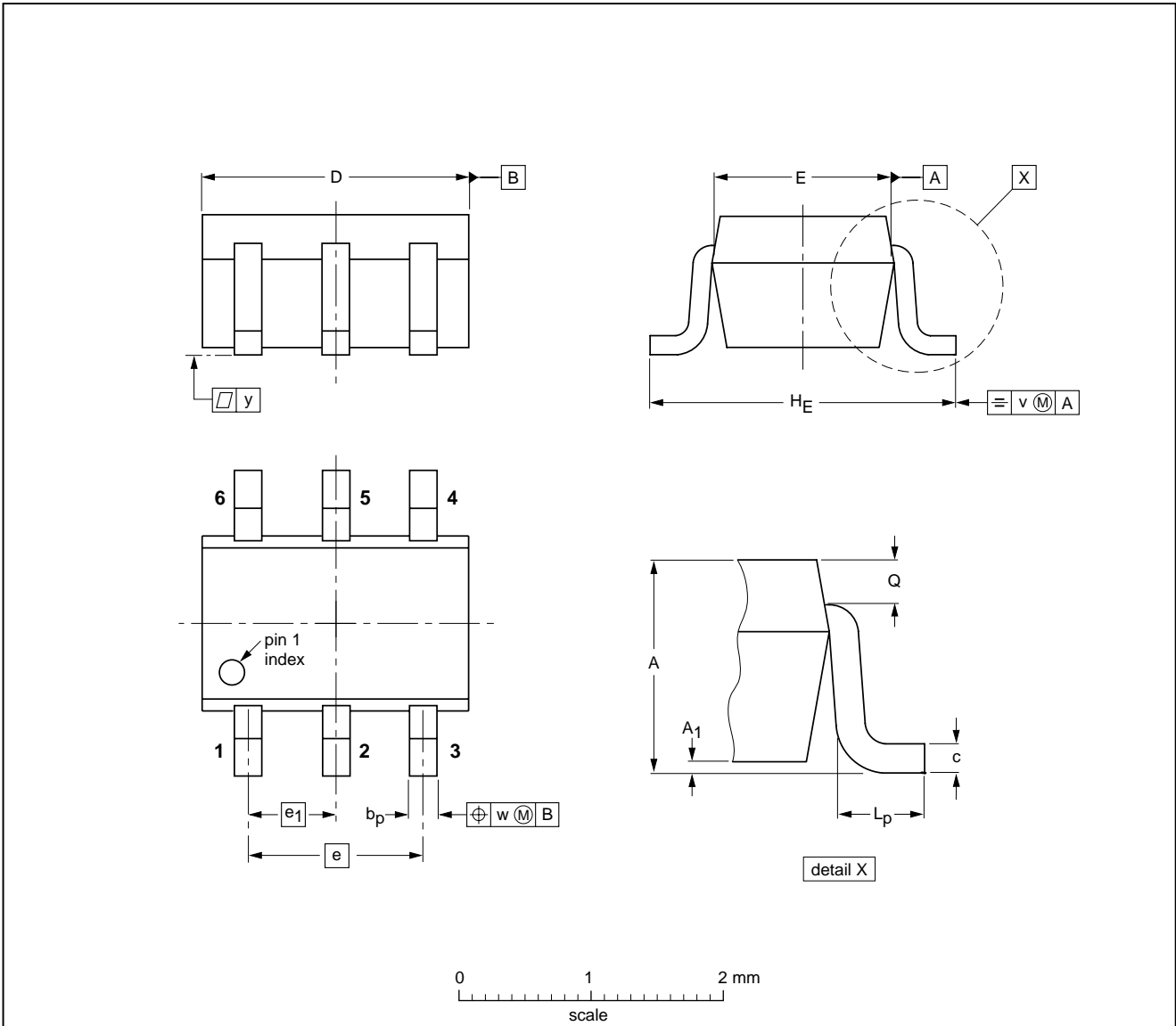

DIMENSIONS (mm are the original dimensions)

UNIT	A	A1 max	bp	c	D	E	e	e1	HE	Lp	Q	v	w	y
mm	1.1 0.8	0.1	0.30 0.20	0.25 0.10	2.2 1.8	1.35 1.15	1.3	0.65	2.2 2.0	0.45 0.15	0.25 0.15	0.2	0.2	0.1

OUTLINE VERSION	REFERENCES				EUROPEAN PROJECTION	ISSUE DATE
	IEC	JEDEC	EIAJ			
SOT363			SC-88			97-02-28

High voltage double diode

BAW101S

DATA SHEET STATUS

LEVEL	DATA SHEET STATUS ⁽¹⁾	PRODUCT STATUS ⁽²⁾⁽³⁾	DEFINITION
I	Objective data	Development	This data sheet contains data from the objective specification for product development. Philips Semiconductors reserves the right to change the specification in any manner without notice.
II	Preliminary data	Qualification	This data sheet contains data from the preliminary specification. Supplementary data will be published at a later date. Philips Semiconductors reserves the right to change the specification without notice, in order to improve the design and supply the best possible product.
III	Product data	Production	This data sheet contains data from the product specification. Philips Semiconductors reserves the right to make changes at any time in order to improve the design, manufacturing and supply. Relevant changes will be communicated via a Customer Product/Process Change Notification (CPCN).

Notes

1. Please consult the most recently issued data sheet before initiating or completing a design.
2. The product status of the device(s) described in this data sheet may have changed since this data sheet was published. The latest information is available on the Internet at URL <http://www.semiconductors.philips.com>.
3. For data sheets describing multiple type numbers, the highest-level product status determines the data sheet status.

DEFINITIONS

Short-form specification — The data in a short-form specification is extracted from a full data sheet with the same type number and title. For detailed information see the relevant data sheet or data handbook.

Limiting values definition — Limiting values given are in accordance with the Absolute Maximum Rating System (IEC 60134). Stress above one or more of the limiting values may cause permanent damage to the device. These are stress ratings only and operation of the device at these or at any other conditions above those given in the Characteristics sections of the specification is not implied. Exposure to limiting values for extended periods may affect device reliability.

Application information — Applications that are described herein for any of these products are for illustrative purposes only. Philips Semiconductors make no representation or warranty that such applications will be suitable for the specified use without further testing or modification.

DISCLAIMERS

Life support applications — These products are not designed for use in life support appliances, devices, or systems where malfunction of these products can reasonably be expected to result in personal injury. Philips Semiconductors customers using or selling these products for use in such applications do so at their own risk and agree to fully indemnify Philips Semiconductors for any damages resulting from such application.

Right to make changes — Philips Semiconductors reserves the right to make changes in the products - including circuits, standard cells, and/or software - described or contained herein in order to improve design and/or performance. When the product is in full production (status 'Production'), relevant changes will be communicated via a Customer Product/Process Change Notification (CPCN). Philips Semiconductors assumes no responsibility or liability for the use of any of these products, conveys no licence or title under any patent, copyright, or mask work right to these products, and makes no representations or warranties that these products are free from patent, copyright, or mask work right infringement, unless otherwise specified.

High voltage double diode

BAW101S

NOTES

High voltage double diode

BAW101S

NOTES

High voltage double diode

BAW101S

NOTES

Philips Semiconductors – a worldwide company

Contact information

For additional information please visit <http://www.semiconductors.philips.com>. Fax: +31 40 27 24825

For sales offices addresses send e-mail to: sales.addresses@www.semiconductors.philips.com.

© Koninklijke Philips Electronics N.V. 2003

SCA75

All rights are reserved. Reproduction in whole or in part is prohibited without the prior written consent of the copyright owner.

The information presented in this document does not form part of any quotation or contract, is believed to be accurate and reliable and may be changed without notice. No liability will be accepted by the publisher for any consequence of its use. Publication thereof does not convey nor imply any license under patent- or other industrial or intellectual property rights.

Printed in The Netherlands

613514/01/pp12

Date of release: 2003 May 13

Document order number: 9397 750 11148

Let's make things better.

**Philips
Semiconductors**



PHILIPS