

# DATA SHEET

**BF904WR**

**N-channel dual-gate MOS-FET**

Product specification  
File under Discrete Semiconductors, SC07

1995 Apr 25

**Philips Semiconductors**



**PHILIPS**

# N-channel dual-gate MOS-FET

# BF904WR

### FEATURES

- Specially designed for use at 5 V supply voltage
- Short channel transistor with high forward transfer admittance to input capacitance ratio
- Low noise gain controlled amplifier up to 1 GHz
- Superior cross-modulation performance during AGC.

### APPLICATIONS

- VHF and UHF applications with 3 to 7 V supply voltage such as television tuners and professional communications equipment.

### DESCRIPTION

Enhancement type field-effect transistor in a plastic microminiature SOT343R package. The transistor consists of an amplifier MOS-FET with source and substrate interconnected and an internal bias circuit to ensure good cross-modulation performance during AGC.

**CAUTION**

The device is supplied in an antistatic package. The gate-source input must be protected against static discharge during transport or handling.

### PINNING

PIN	SYMBOL	DESCRIPTION
1	s, b	source
2	d	drain
3	g <sub>2</sub>	gate 2
4	g <sub>1</sub>	gate 1

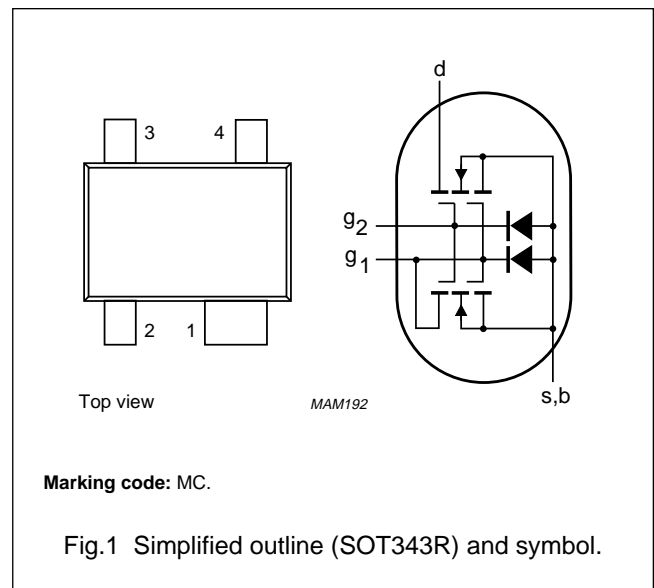

### QUICK REFERENCE DATA

SYMBOL	PARAMETER	CONDITIONS	MIN.	TYP.	MAX.	UNIT
V <sub>DS</sub>	drain-source voltage		–	–	7	V
I <sub>D</sub>	drain current		–	–	30	mA
P <sub>tot</sub>	total power dissipation		–	–	280	mW
T <sub>j</sub>	operating junction temperature		–	–	150	°C
y <sub>fs</sub>	forward transfer admittance		22	25	30	mS
C <sub>ig1-s</sub>	input capacitance at gate 1		–	2.2	2.6	pF
C <sub>rs</sub>	reverse transfer capacitance	f = 1 MHz	–	25	35	fF
F	noise figure	f = 800 MHz	–	2	–	dB

N-channel dual-gate MOS-FET

BF904WR

**LIMITING VALUES**

In accordance with the Absolute Maximum Rating System (IEC 134).

SYMBOL	PARAMETER	CONDITIONS	MIN.	MAX.	UNIT
$V_{DS}$	drain-source voltage		–	7	V
$I_D$	drain current		–	30	mA
$I_{G1}$	gate 1 current		–	$\pm 10$	mA
$I_{G2}$	gate 2 current		–	$\pm 10$	mA
$P_{tot}$	total power dissipation	up to $T_{amb} = 50\text{ }^\circ\text{C}$ ; see Fig.2; note 1	–	280	mW
$T_{stg}$	storage temperature		–65	+150	$^\circ\text{C}$
$T_j$	operating junction temperature		–	+150	$^\circ\text{C}$

**Note**

1. Device mounted on a printed-circuit board.

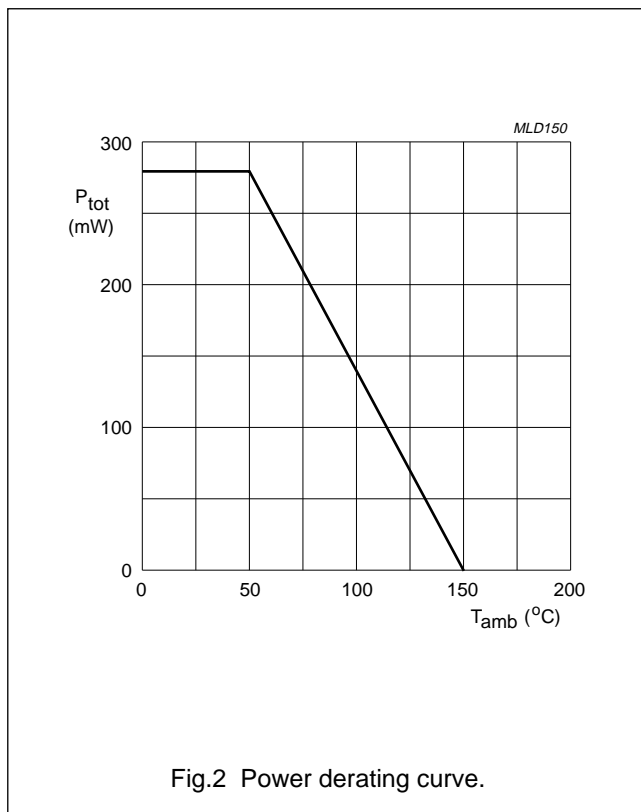

## N-channel dual-gate MOS-FET

BF904WR

## THERMAL CHARACTERISTICS

SYMBOL	PARAMETER	CONDITIONS	VALUE	UNIT
$R_{th\ j-a}$	thermal resistance from junction to ambient	note 1	350	K/W
$R_{th\ j-s}$	thermal resistance from junction to soldering point	$T_s = 91\text{ °C}$ ; note 2	210	K/W

## Notes

1. Device mounted on a printed-circuit board.
2.  $T_s$  is the temperature at the soldering point of the source lead.

## STATIC CHARACTERISTICS

$T_j = 25\text{ °C}$ ; unless otherwise specified.

SYMBOL	PARAMETER	CONDITIONS	MIN.	MAX.	UNIT
$V_{(BR)G1-SS}$	gate 1-source breakdown voltage	$V_{G2-S} = V_{DS} = 0$ ; $I_{G1-S} = 10\text{ mA}$	6	15	V
$V_{(BR)G2-SS}$	gate 2-source breakdown voltage	$V_{G1-S} = V_{DS} = 0$ ; $I_{G2-S} = 10\text{ mA}$	6	15	V
$V_{(F)S-G1}$	forward source-gate 1 voltage	$V_{G2-S} = V_{DS} = 0$ ; $I_{S-G1} = 10\text{ mA}$	0.5	1.5	V
$V_{(F)S-G2}$	forward source-gate 2 voltage	$V_{G1-S} = V_{DS} = 0$ ; $I_{S-G2} = 10\text{ mA}$	0.5	1.5	V
$V_{G1-S(th)}$	gate 1-source threshold voltage	$V_{G2-S} = 4\text{ V}$ ; $V_{DS} = 5\text{ V}$ ; $I_D = 20\text{ }\mu\text{A}$	0.3	1	V
$V_{G2-S(th)}$	gate 2-source threshold voltage	$V_{G1-S} = V_{DS} = 5\text{ V}$ ; $I_D = 20\text{ }\mu\text{A}$	0.3	1.2	V
$I_{DSX}$	drain-source current	$V_{G2-S} = 4\text{ V}$ ; $V_{DS} = 5\text{ V}$ ; $R_{G1} = 120\text{ k}\Omega$ ; note 1	8	13	mA
$I_{G1-SS}$	gate 1 cut-off current	$V_{G2-S} = V_{DS} = 0$ ; $V_{G1-S} = 5\text{ V}$	–	50	nA
$I_{G2-SS}$	gate 2 cut-off current	$V_{G1-S} = V_{DS} = 0$ ; $V_{G2-S} = 5\text{ V}$	–	50	nA

## Note

1.  $R_G$  connects gate 1 to  $V_{GG} = 5\text{ V}$ .

## DYNAMIC CHARACTERISTICS

Common source;  $T_{amb} = 25\text{ °C}$ ;  $V_{DS} = 5\text{ V}$ ;  $V_{G2-S} = 4\text{ V}$ ;  $I_D = 10\text{ mA}$ ; unless otherwise specified.

SYMBOL	PARAMETER	CONDITIONS	MIN.	TYP.	MAX.	UNIT
$ y_{fs} $	forward transfer admittance	pulsed; $T_j = 25\text{ °C}$	22	25	30	mS
$C_{ig1-s}$	input capacitance at gate 1	$f = 1\text{ MHz}$	–	2.2	2.6	pF
$C_{ig2-s}$	input capacitance at gate 2	$f = 1\text{ MHz}$	1	1.5	2	pF
$C_{os}$	drain-source capacitance	$f = 1\text{ MHz}$	1	1.3	1.6	pF
$C_{rs}$	reverse transfer capacitance	$f = 1\text{ MHz}$	–	25	35	fF
F	noise figure	$f = 200\text{ MHz}$ ; $G_S = 2\text{ mS}$ ; $B_S = B_{Sopt}$	–	1	1.5	dB
		$f = 800\text{ MHz}$ ; $G_S = G_{Sopt}$ ; $B_S = B_{Sopt}$	–	2	2.8	dB

N-channel dual-gate MOS-FET

BF904WR

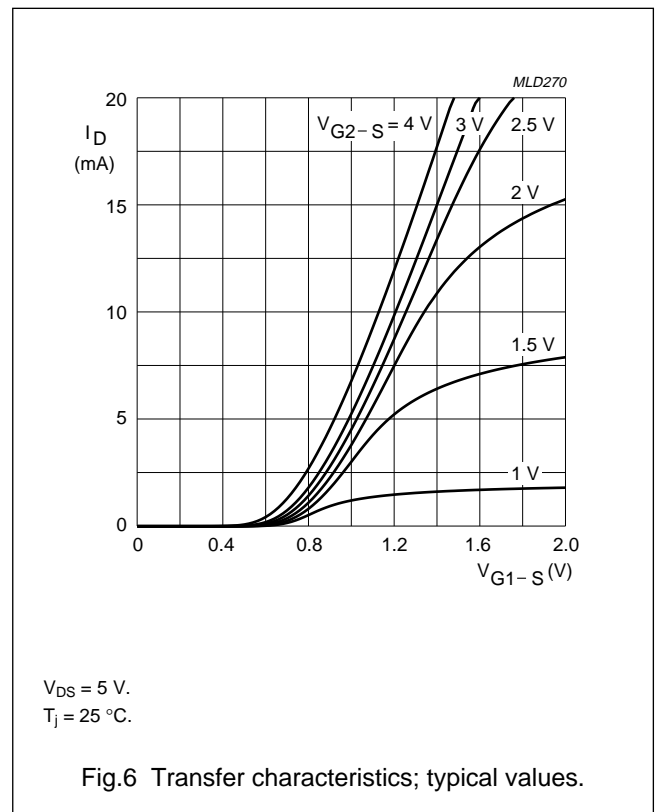
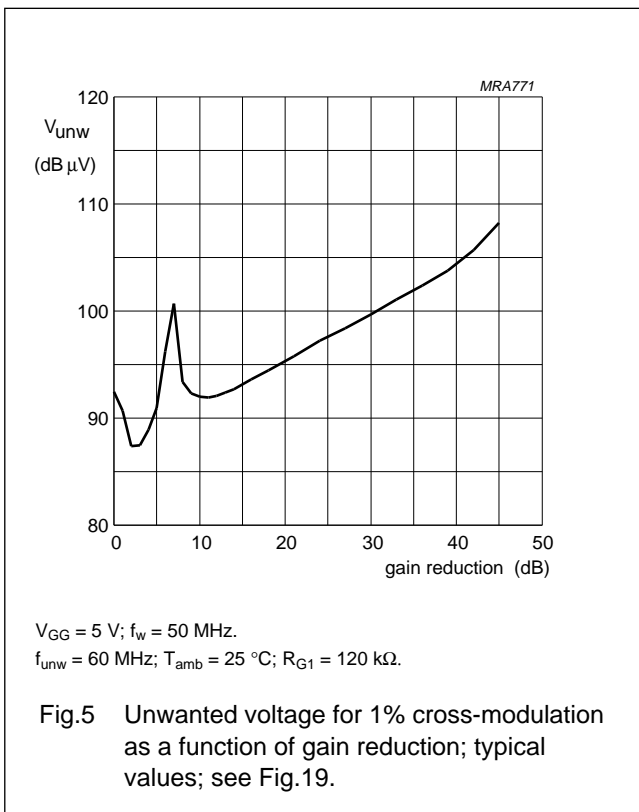
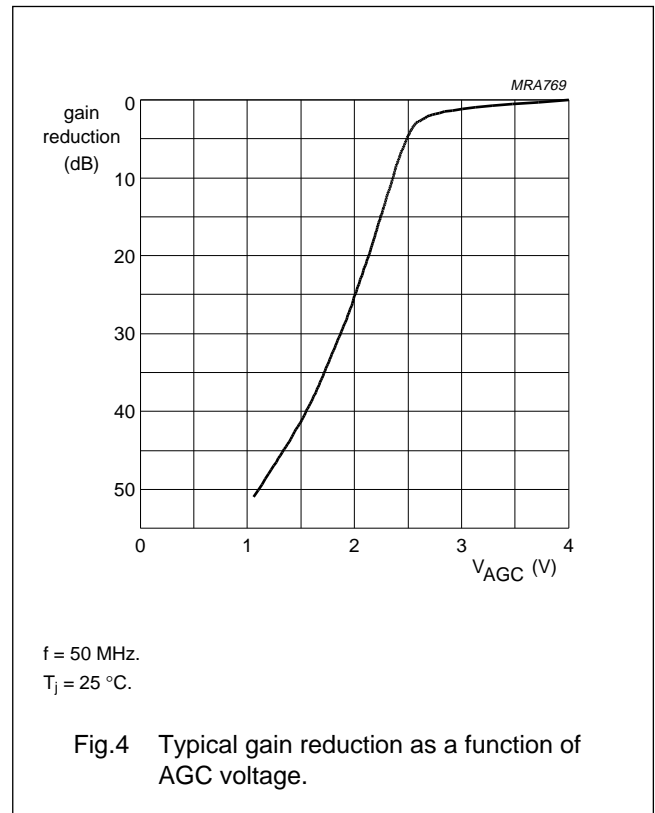
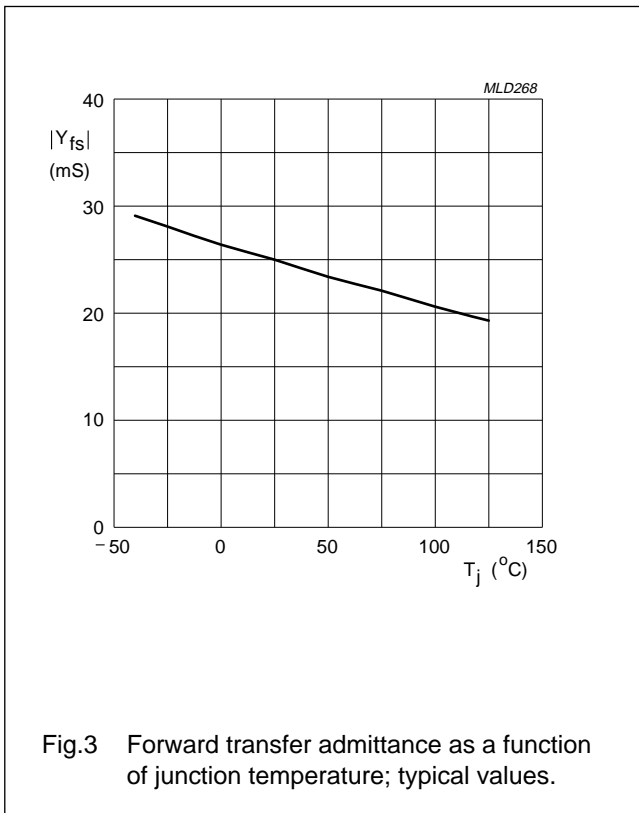

N-channel dual-gate MOS-FET

BF904WR

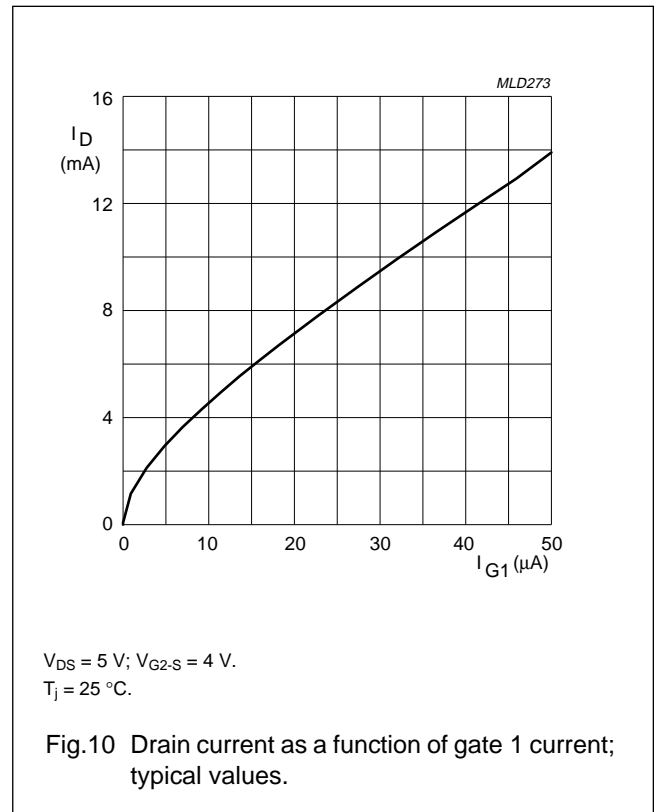
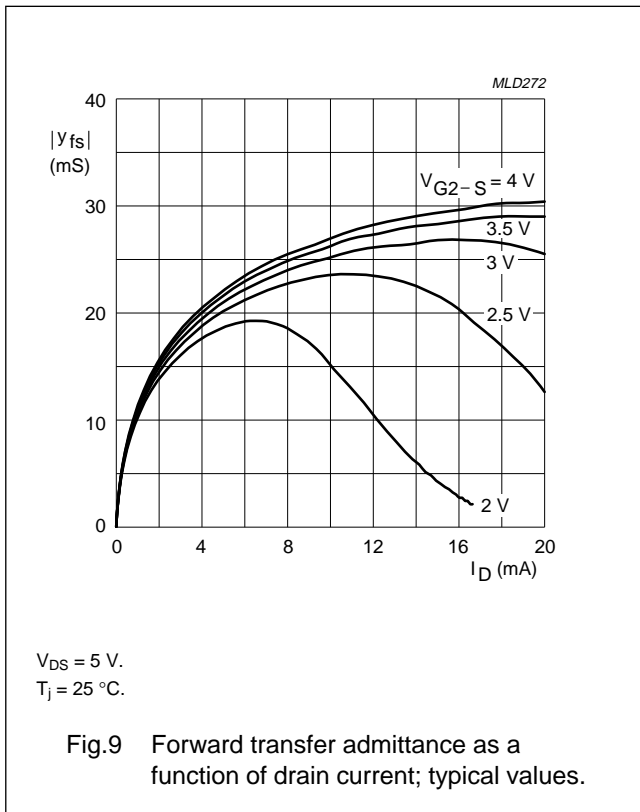
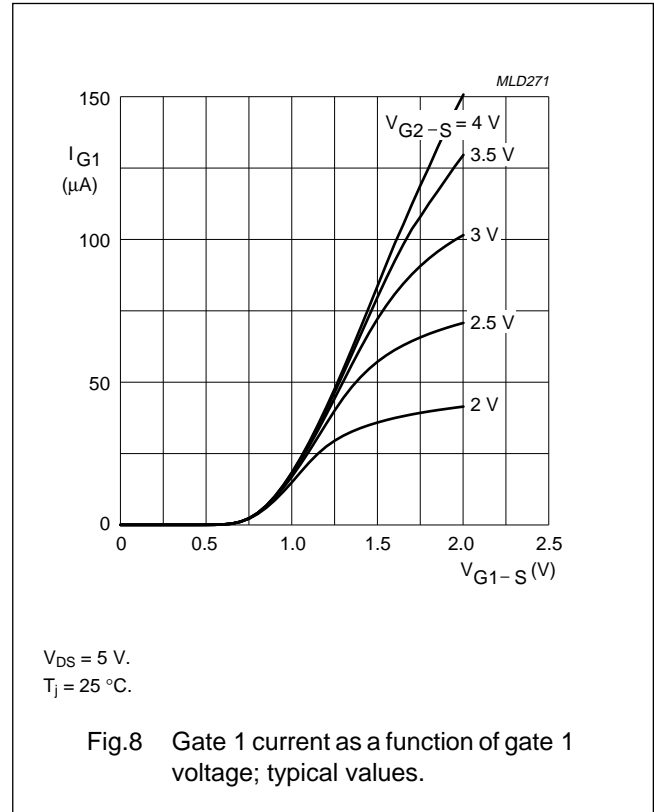
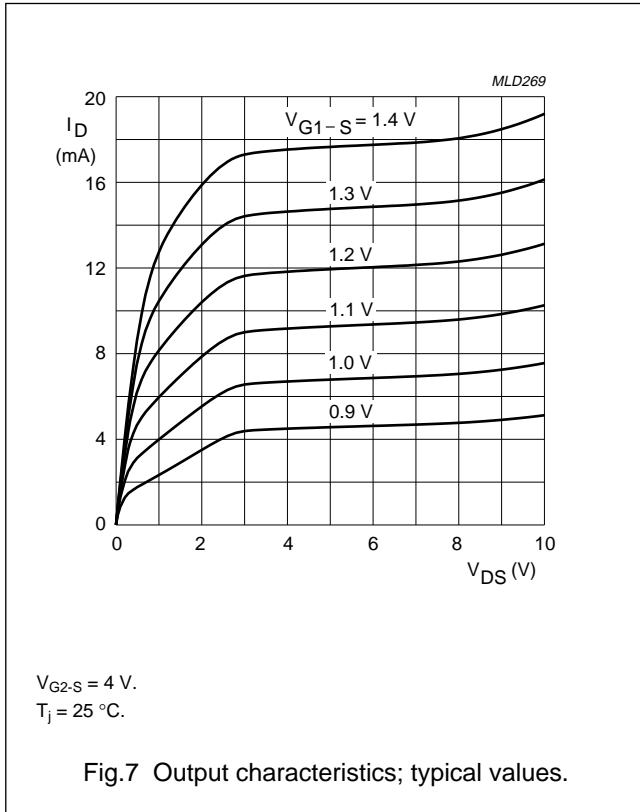

N-channel dual-gate MOS-FET

BF904WR

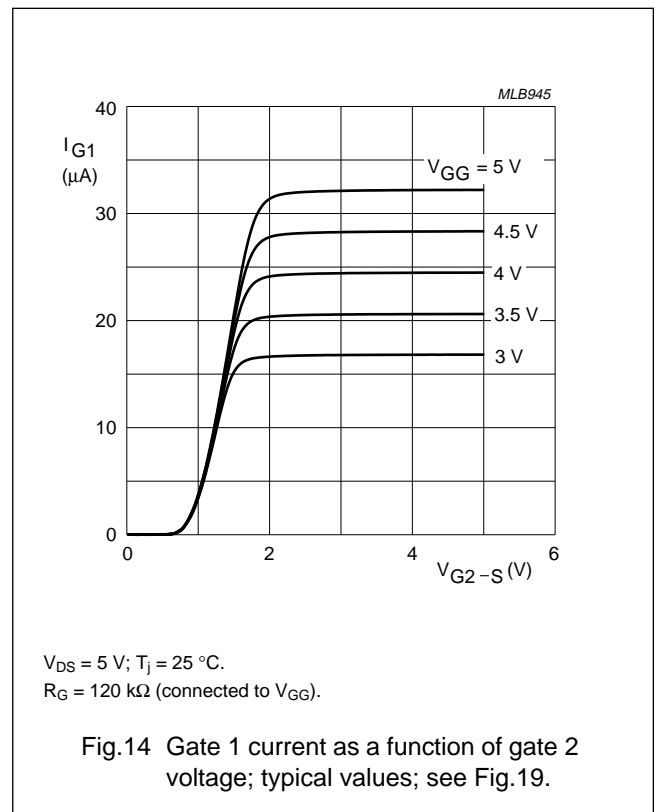
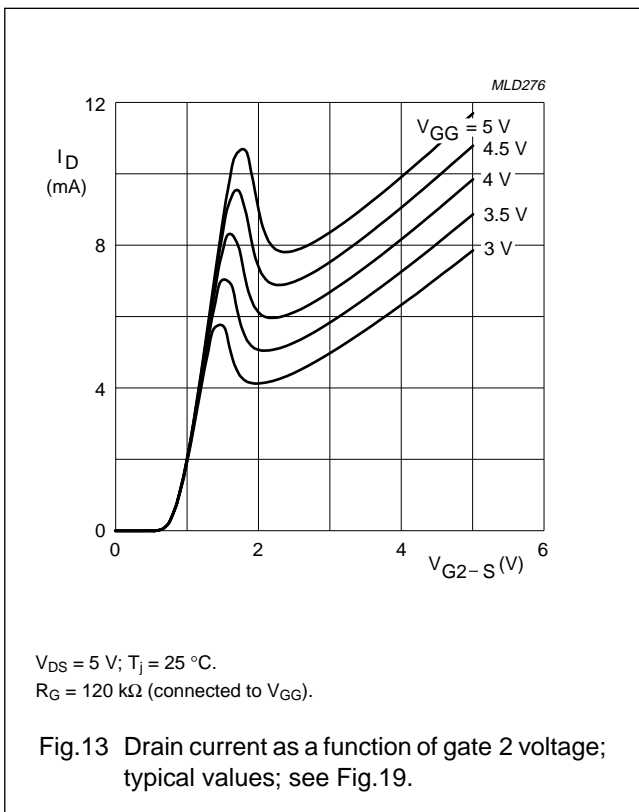
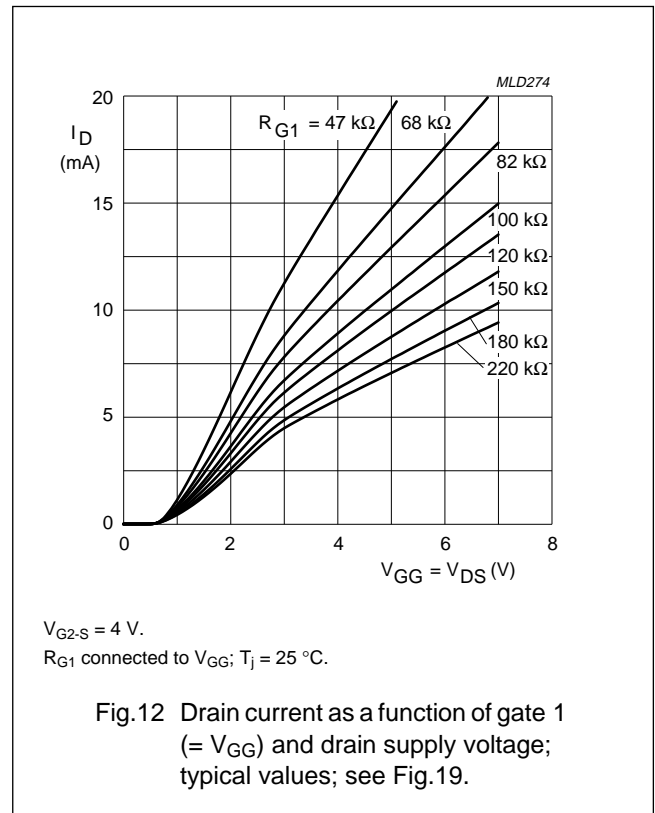
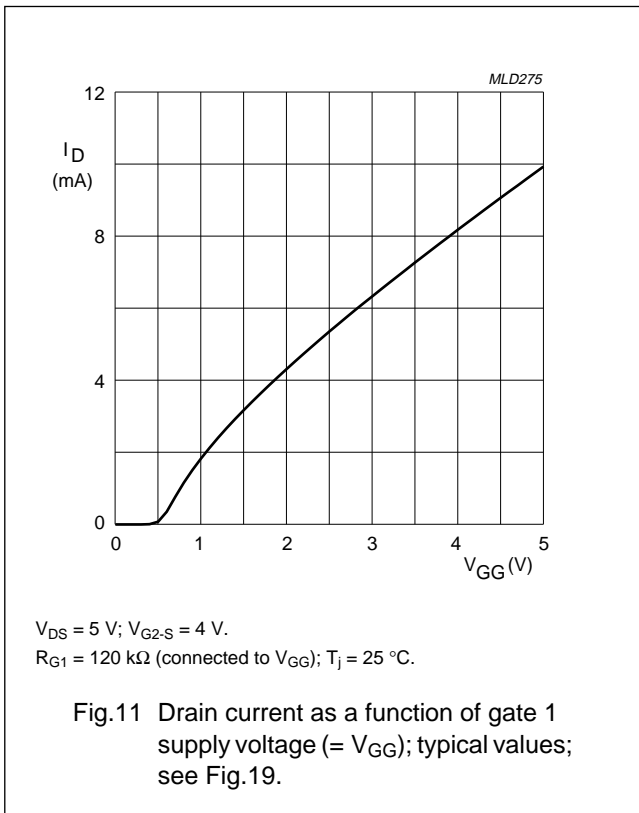

N-channel dual-gate MOS-FET

BF904WR

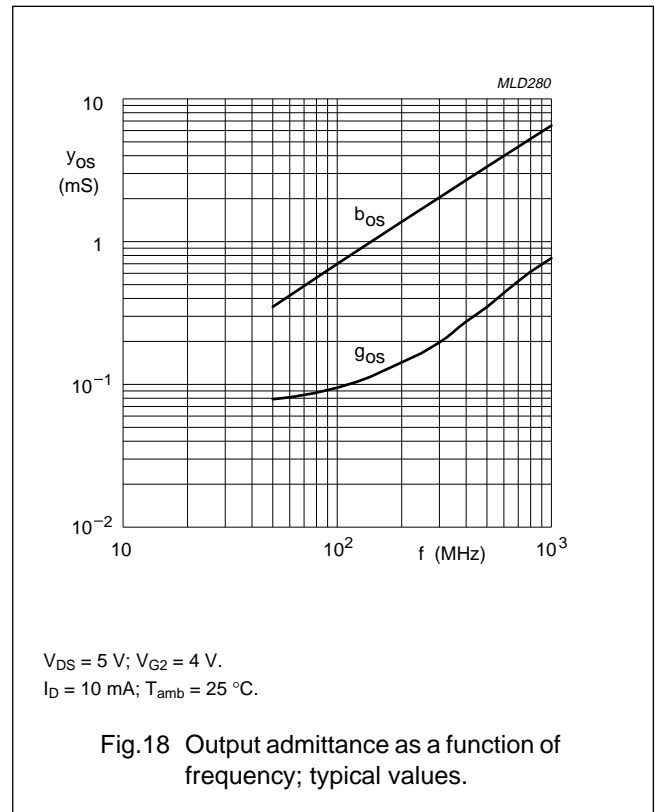
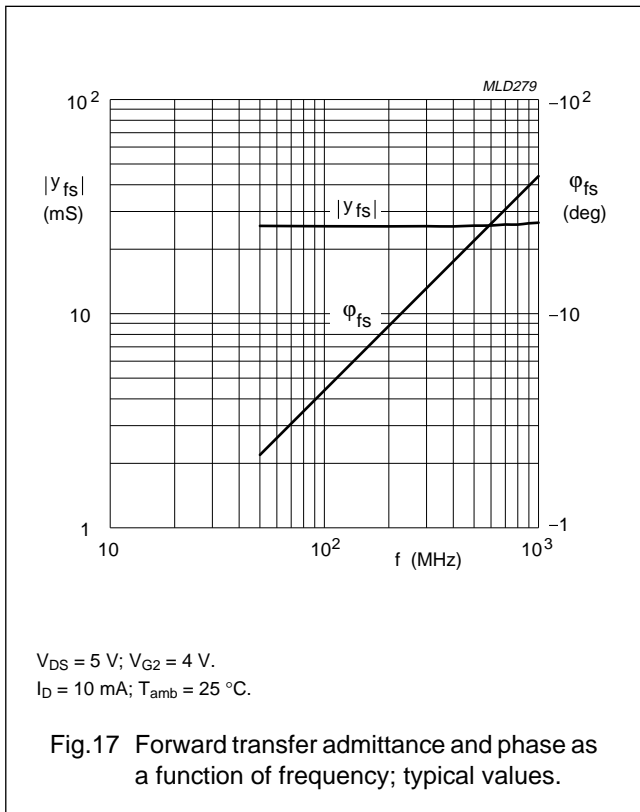
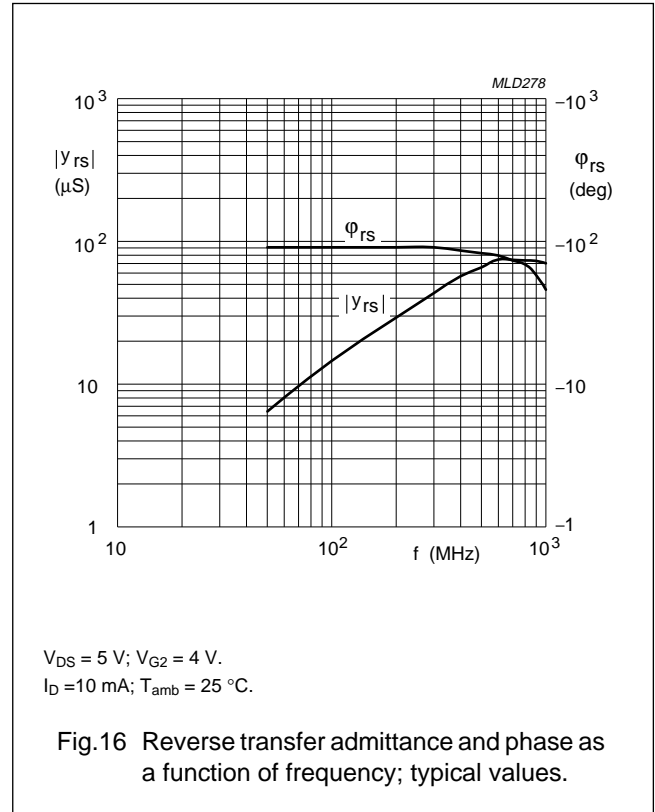
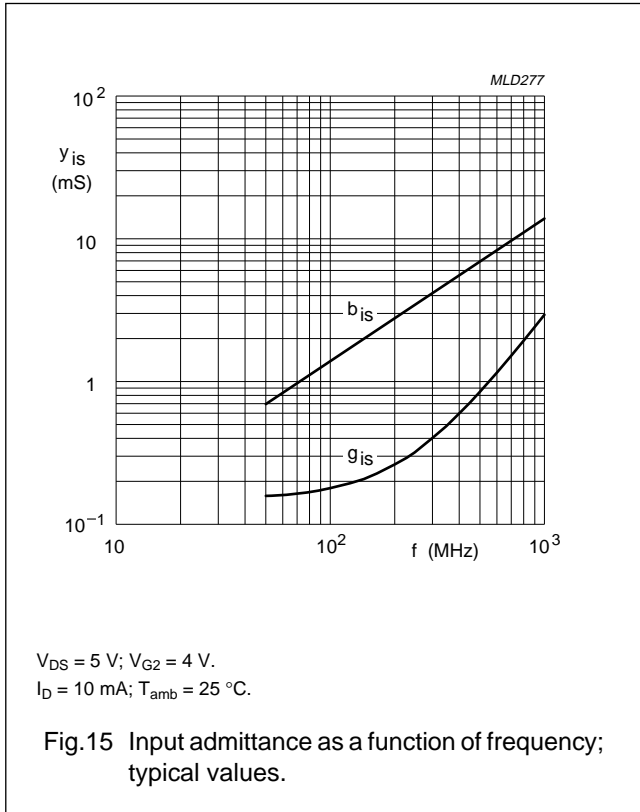

N-channel dual-gate MOS-FET

BF904WR

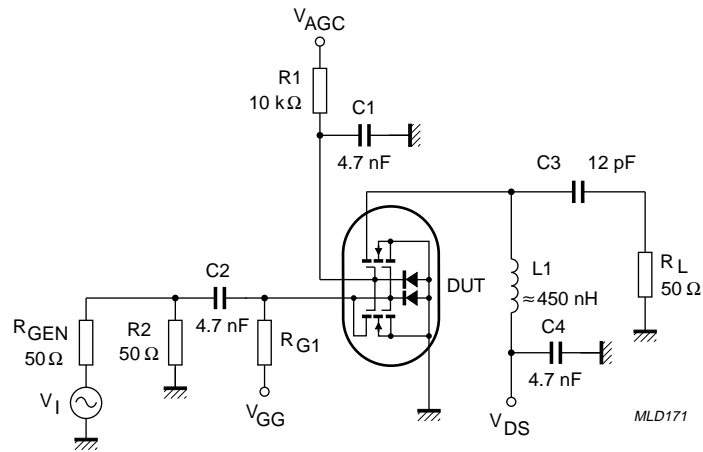

Fig.19 Cross-modulation test set-up.

## N-channel dual-gate MOS-FET

BF904WR

**Table 1** Scattering parameters:  $V_{DS} = 5\text{ V}$ ;  $V_{G2-S} = 4\text{ V}$ ;  $I_D = 10\text{ mA}$ 

f (MHz)	S <sub>11</sub>		S <sub>21</sub>		S <sub>12</sub>		S <sub>22</sub>	
	MAGNITUDE (ratio)	ANGLE (deg)	MAGNITUDE (ratio)	ANGLE (deg)	MAGNITUDE (ratio)	ANGLE (deg)	MAGNITUDE (ratio)	ANGLE (deg)
40	0.989	-3.4	2.420	175.7	0.000	79.9	0.993	-1.6
100	0.985	-8.3	2.414	169.1	0.001	78.3	0.992	-3.9
200	0.976	-16.4	2.368	158.8	0.003	80.3	0.987	-7.8
300	0.958	-24.1	2.301	148.5	0.004	73.7	0.980	-11.4
400	0.942	-32.0	2.251	138.8	0.005	70.7	0.974	-15.2
500	0.918	-39.3	2.170	129.5	0.005	67.2	0.966	-18.7
600	0.899	-46.0	2.080	120.7	0.005	67.8	0.958	-22.2
700	0.876	-52.6	2.001	112.1	0.005	68.6	0.951	-25.5
800	0.852	-58.8	1.924	103.2	0.005	72.9	0.944	-28.9
900	0.823	-64.9	1.829	94.7	0.005	78.7	0.937	-32.1
1000	0.800	-70.9	1.747	86.5	0.005	88.3	0.933	-35.2
1200	0.750	-82.4	1.621	70.7	0.005	120.5	0.928	-41.7
1400	0.719	-92.7	1.535	54.6	0.008	139.8	0.930	-48.4
1600	0.682	-102.5	1.424	39.4	0.010	137.8	0.924	-54.9
1800	0.642	-109.8	1.349	22.5	0.013	156.8	0.928	-62.9
2000	0.602	-116.5	1.283	1.1	0.018	175.1	0.928	-73.1
2200	0.547	-124.9	1.130	-15.1	0.014	172.6	0.887	-81.0
2400	0.596	-128.7	1.018	-49.1	0.040	-163.9	0.837	-95.8
2600	0.682	-132.6	0.979	-79.4	0.077	-164.0	0.778	-109.6
2800	0.771	-142.5	0.804	-116.2	0.120	178.8	0.629	-119.5
3000	0.793	-157.5	0.541	-153.5	0.149	158.3	0.479	-119.9

**Table 2** Noise data:  $V_{DS} = 5\text{ V}$ ;  $V_{G2-S} = 4\text{ V}$ ;  $I_D = 10\text{ mA}$ 

f (MHz)	F <sub>min</sub> (dB)	Γ <sub>opt</sub>		r <sub>n</sub>
		(ratio)	(deg)	
800	2.00	.686	49.6	50.40

# N-channel dual-gate MOS-FET

# BF904WR

## PACKAGE OUTLINE

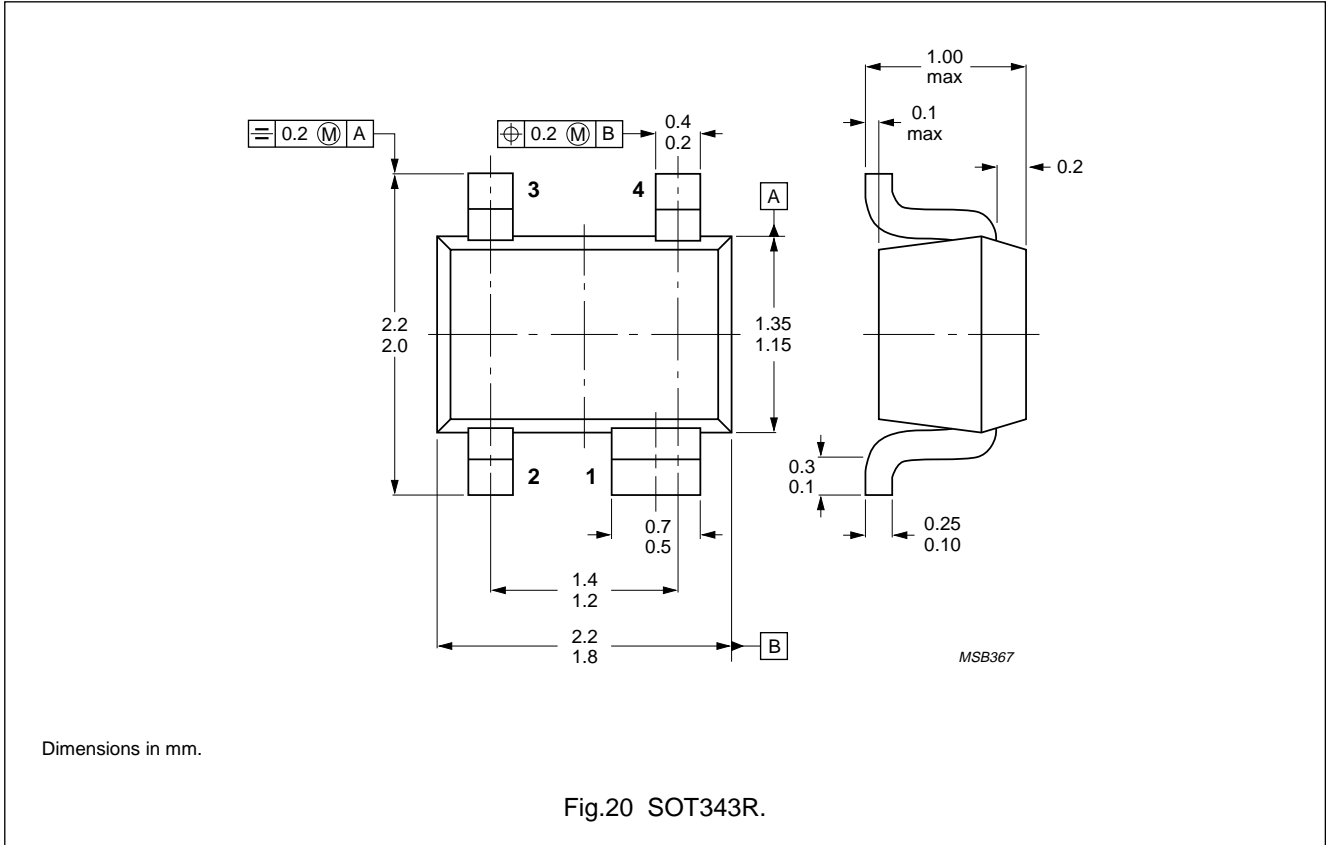

## N-channel dual-gate MOS-FET

BF904WR

**DEFINITIONS**

<b>Data Sheet Status</b>	
Objective specification	This data sheet contains target or goal specifications for product development.
Preliminary specification	This data sheet contains preliminary data; supplementary data may be published later.
Product specification	This data sheet contains final product specifications.
<b>Limiting values</b>	
Limiting values given are in accordance with the Absolute Maximum Rating System (IEC 134). Stress above one or more of the limiting values may cause permanent damage to the device. These are stress ratings only and operation of the device at these or at any other conditions above those given in the Characteristics sections of the specification is not implied. Exposure to limiting values for extended periods may affect device reliability.	
<b>Application information</b>	
Where application information is given, it is advisory and does not form part of the specification.	

**LIFE SUPPORT APPLICATIONS**

These products are not designed for use in life support appliances, devices, or systems where malfunction of these products can reasonably be expected to result in personal injury. Philips customers using or selling these products for use in such applications do so at their own risk and agree to fully indemnify Philips for any damages resulting from such improper use or sale.