

DATA SHEET

BFR520

NPN 9 GHz wideband transistor

Product specification
File under Discrete Semiconductors, SC14

September 1995

NPN 9 GHz wideband transistor

BFR520

FEATURES

- High power gain
- Low noise figure
- High transition frequency
- Gold metallization ensures excellent reliability.

telephones (CT1, CT2, DECT, etc.), radar detectors, pagers and satellite TV tuners (SATV) and repeater amplifiers in fibre-optic systems.

The transistor is encapsulated in a plastic SOT23 envelope.

DESCRIPTION

The BFR520 is an npn silicon planar epitaxial transistor, intended for applications in the RF frontend in wideband applications in the GHz range, such as analog and digital cellular telephones, cordless

PINNING

PIN	DESCRIPTION
Code: N28	
1	base
2	emitter
3	collector

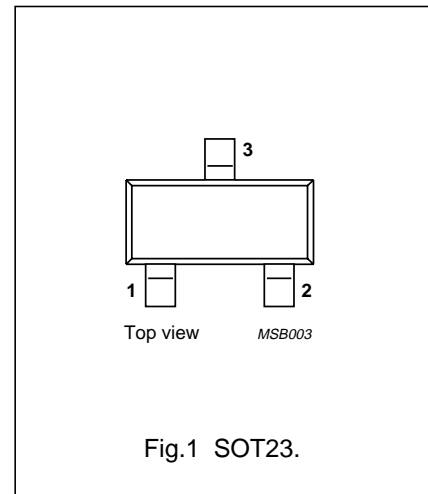

QUICK REFERENCE DATA

SYMBOL	PARAMETER	CONDITIONS	MIN.	TYP.	MAX.	UNIT
V_{CB0}	collector-base voltage		–	–	20	V
V_{CES}	collector-emitter voltage	$R_{BE} = 0$	–	–	15	V
I_C	DC collector current		–	–	70	mA
P_{tot}	total power dissipation	up to $T_s = 97\text{ }^\circ\text{C}$; note 1	–	–	300	mW
h_{FE}	DC current gain	$I_C = 20\text{ mA}$; $V_{CE} = 6\text{ V}$	60	120	250	
C_{re}	feedback capacitance	$I_C = i_c = 0$; $V_{CB} = 6\text{ V}$; $f = 1\text{ MHz}$	–	0.4	–	pF
f_T	transition frequency	$I_C = 20\text{ mA}$; $V_{CE} = 6\text{ V}$; $f = 1\text{ GHz}$	–	9	–	GHz
G_{UM}	maximum unilateral power gain	$I_C = 20\text{ mA}$; $V_{CE} = 6\text{ V}$; $T_{amb} = 25\text{ }^\circ\text{C}$; $f = 900\text{ MHz}$	–	15	–	dB
		$I_C = 20\text{ mA}$; $V_{CE} = 6\text{ V}$; $T_{amb} = 25\text{ }^\circ\text{C}$; $f = 2\text{ GHz}$	–	9	–	dB
$ S_{21} ^2$	insertion power gain	$I_C = 20\text{ mA}$; $V_{CE} = 6\text{ V}$; $T_{amb} = 25\text{ }^\circ\text{C}$; $f = 900\text{ MHz}$	13	14	–	dB
F	noise figure	$\Gamma_s = \Gamma_{opt}$; $I_C = 5\text{ mA}$; $V_{CE} = 6\text{ V}$; $T_{amb} = 25\text{ }^\circ\text{C}$; $f = 900\text{ MHz}$	–	1.1	1.6	dB
		$\Gamma_s = \Gamma_{opt}$; $I_C = 20\text{ mA}$; $V_{CE} = 6\text{ V}$; $T_{amb} = 25\text{ }^\circ\text{C}$; $f = 900\text{ MHz}$	–	1.6	2.1	dB
		$\Gamma_s = \Gamma_{opt}$; $I_C = 5\text{ mA}$; $V_{CE} = 8\text{ V}$; $T_{amb} = 25\text{ }^\circ\text{C}$; $f = 2\text{ GHz}$	–	1.9	–	dB

Note

1. T_s is the temperature at the soldering point of the collector tab.

NPN 9 GHz wideband transistor

BFR520

LIMITING VALUES

In accordance with the Absolute Maximum System (IEC 134).

SYMBOL	PARAMETER	CONDITIONS	MIN.	MAX.	UNIT
V_{CBO}	collector-base voltage	open emitter	–	20	V
V_{CES}	collector-emitter voltage	$R_{BE} = 0$	–	15	V
V_{EBO}	emitter-base voltage	open collector	–	2.5	V
I_C	DC collector current		–	70	mA
P_{tot}	total power dissipation	up to $T_s = 97\text{ °C}$; note 1	–	300	mW
T_{stg}	storage temperature		–65	150	°C
T_j	junction temperature		–	175	°C

THERMAL RESISTANCE

SYMBOL	PARAMETER	THERMAL RESISTANCE
$R_{th\ j-s}$	from junction to soldering point (note 1)	260 K/W

Note

- T_s is the temperature at the soldering point of the collector tab.

NPN 9 GHz wideband transistor

BFR520

CHARACTERISTICS

$T_j = 25\text{ °C}$ unless otherwise specified.

SYMBOL	PARAMETER	CONDITIONS	MIN.	TYP.	MAX.	UNIT
I_{CBO}	collector cut-off current	$I_E = 0; V_{CB} = 6\text{ V}$	–	–	50	nA
h_{FE}	DC current gain	$I_C = 20\text{ mA}; V_{CE} = 6\text{ V}$	60	120	250	
C_e	emitter capacitance	$I_C = I_e = 0; V_{EB} = 0.5\text{ V}; f = 1\text{ MHz}$	–	1	–	pF
C_c	collector capacitance	$I_E = I_e = 0; V_{CB} = 6\text{ V}; f = 1\text{ MHz}$	–	0.5	–	pF
C_{re}	feedback capacitance	$I_C = 0; V_{CB} = 6\text{ V}; f = 1\text{ MHz}$	–	0.4	–	pF
f_T	transition frequency	$I_C = 20\text{ mA}; V_{CE} = 6\text{ V}; f = 1\text{ GHz}$	–	9	–	GHz
G_{UM}	maximum unilateral power gain (note 1)	$I_C = 20\text{ mA}; V_{CE} = 6\text{ V};$ $T_{amb} = 25\text{ °C}; f = 900\text{ MHz}$	–	15	–	dB
		$I_C = 20\text{ mA}; V_{CE} = 6\text{ V};$ $T_{amb} = 25\text{ °C}; f = 2\text{ GHz}$	–	9	–	dB
$ S_{21} ^2$	insertion power gain	$I_C = 20\text{ mA}; V_{CE} = 6\text{ V};$ $T_{amb} = 25\text{ °C}; f = 900\text{ MHz}$	13	14	–	dB
F	noise figure	$\Gamma_s = \Gamma_{opt}; I_C = 5\text{ mA}; V_{CE} = 6\text{ V};$ $T_{amb} = 25\text{ °C}; f = 900\text{ MHz}$	–	1.1	1.6	dB
		$\Gamma_s = \Gamma_{opt}; I_C = 20\text{ mA}; V_{CE} = 6\text{ V};$ $T_{amb} = 25\text{ °C}; f = 900\text{ MHz}$	–	1.6	2.1	dB
		$\Gamma_s = \Gamma_{opt}; I_C = 5\text{ mA}; V_{CE} = 6\text{ V};$ $T_{amb} = 25\text{ °C}; f = 2\text{ GHz}$	–	1.9	–	dB
P_{L1}	output power at 1 dB gain compression	$I_C = 20\text{ mA}; V_{CE} = 6\text{ V}; R_L = 50\text{ }\Omega;$ $T_{amb} = 25\text{ °C}; f = 900\text{ MHz}$	–	17	–	dBm
ITO	third order intercept point	note 2	–	26	–	dBm

Notes

1. G_{UM} is the maximum unilateral power gain, assuming S_{12} is zero and

$$G_{UM} = 10 \log \frac{|S_{21}|^2}{(1 - |S_{11}|^2)(1 - |S_{22}|^2)} \text{ dB.}$$

2. $I_C = 20\text{ mA}; V_{CE} = 6\text{ V}; R_L = 50\text{ }\Omega; T_{amb} = 25\text{ °C};$
 $f_p = 900\text{ MHz}; f_q = 902\text{ MHz};$
 measured at $f_{(2p-q)} = 898\text{ MHz}$ and $f_{(2q-p)} = 904\text{ MHz}.$

NPN 9 GHz wideband transistor

BFR520

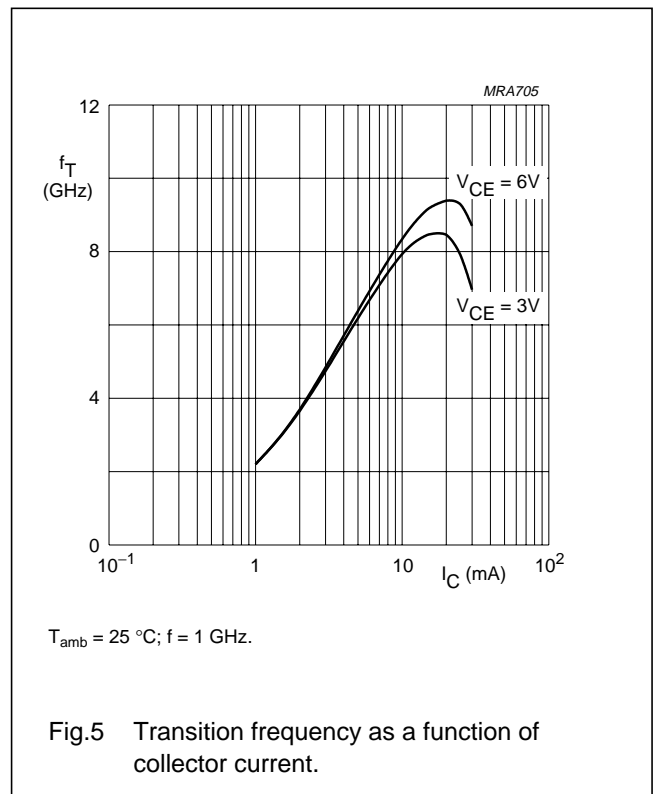
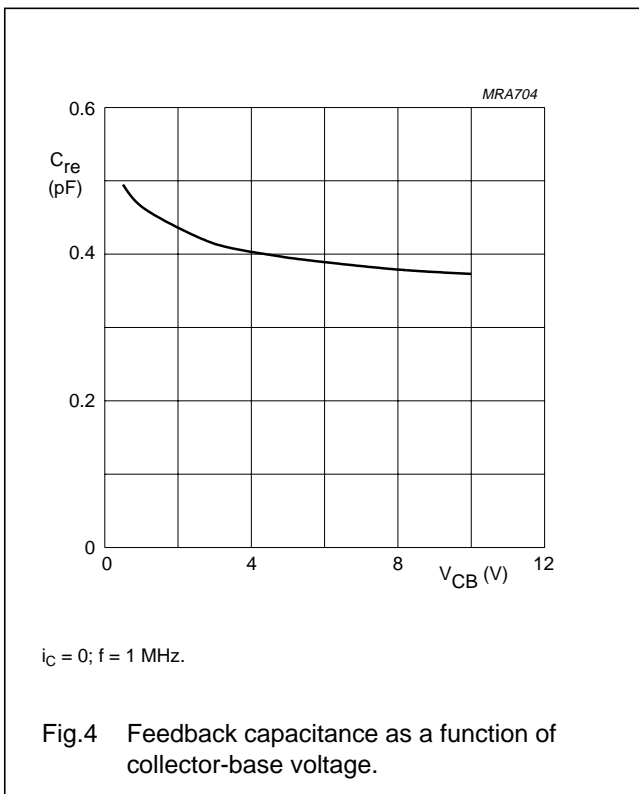
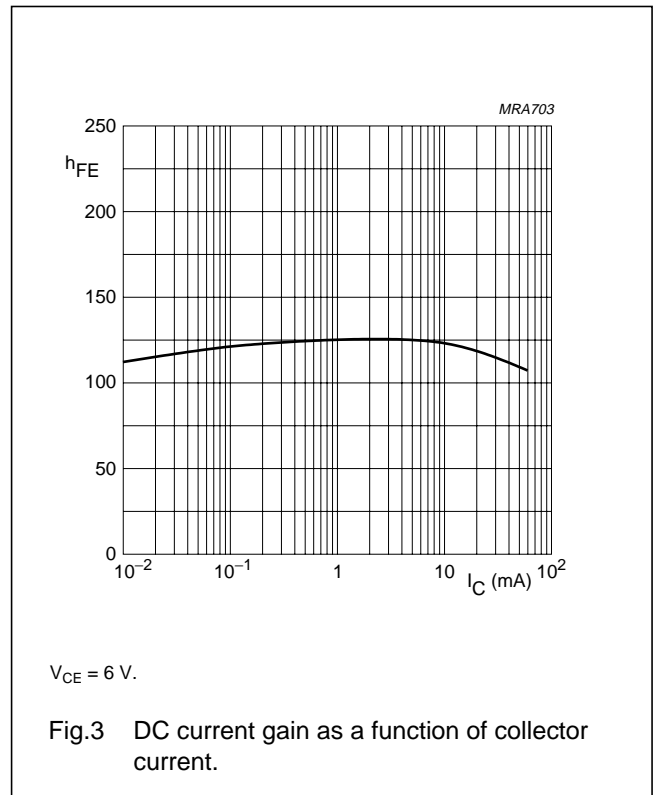
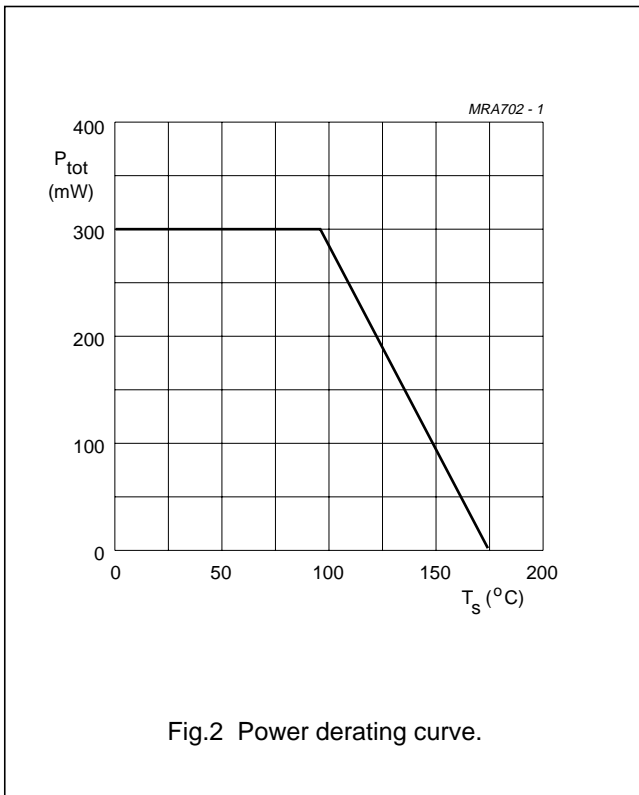

NPN 9 GHz wideband transistor

BFR520

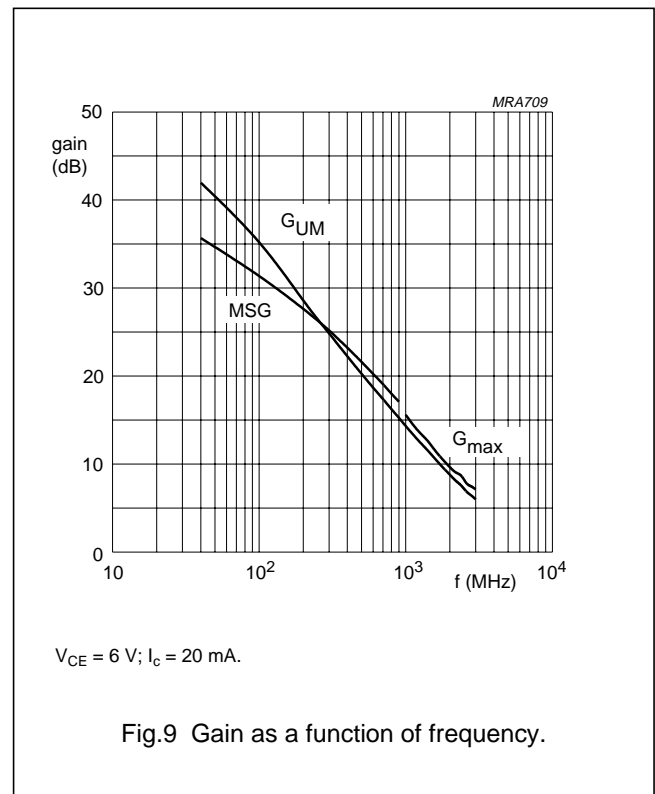
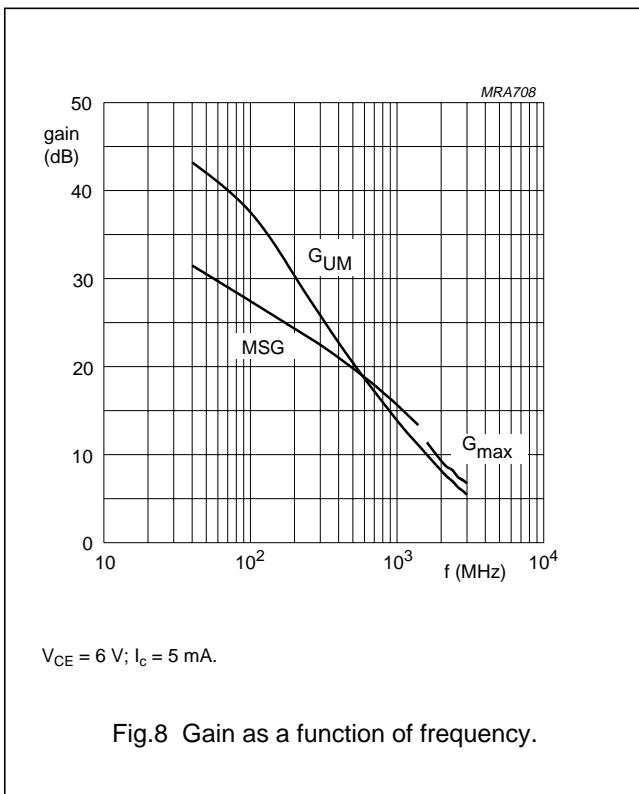
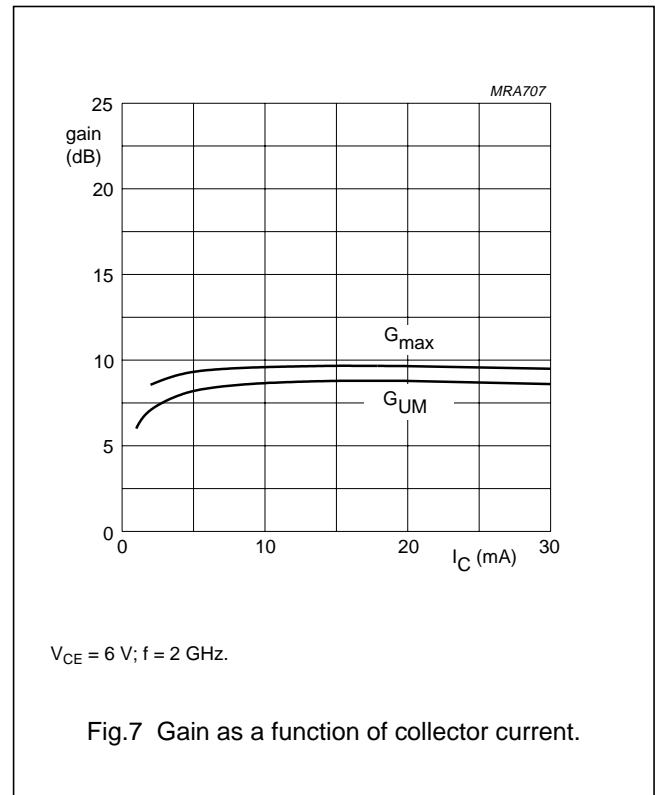
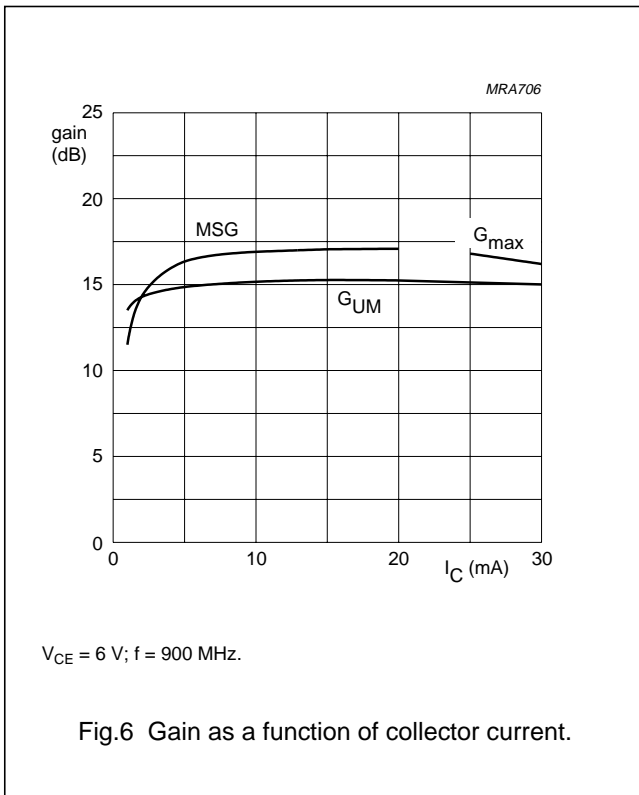

NPN 9 GHz wideband transistor

BFR520

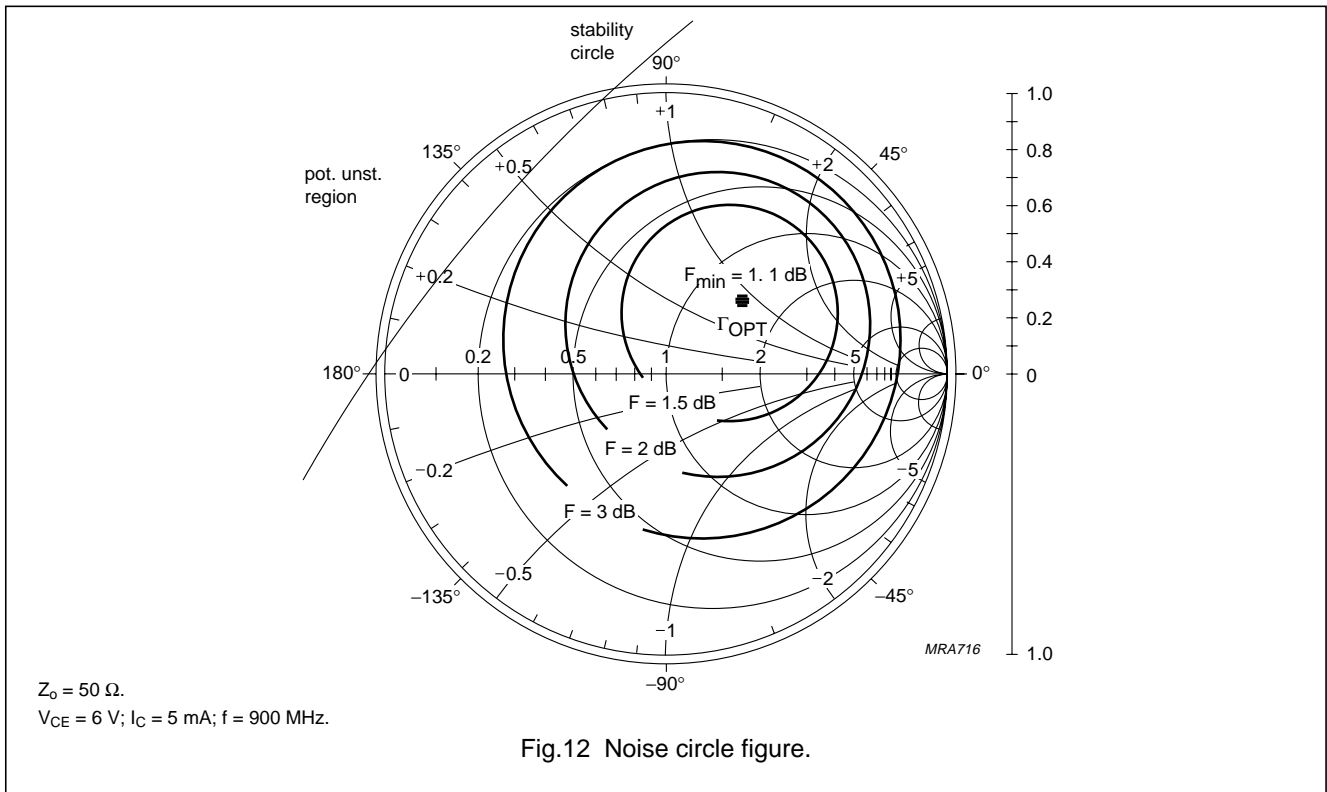
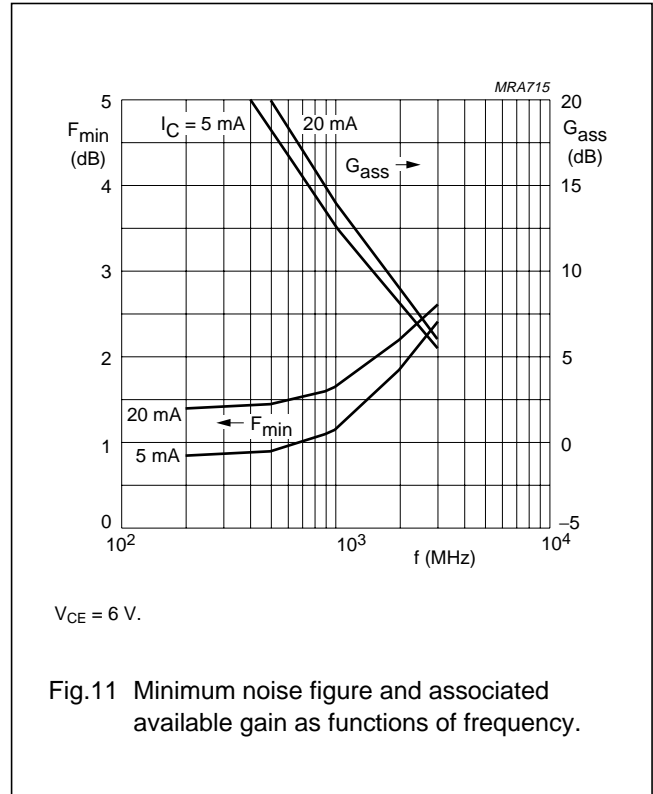
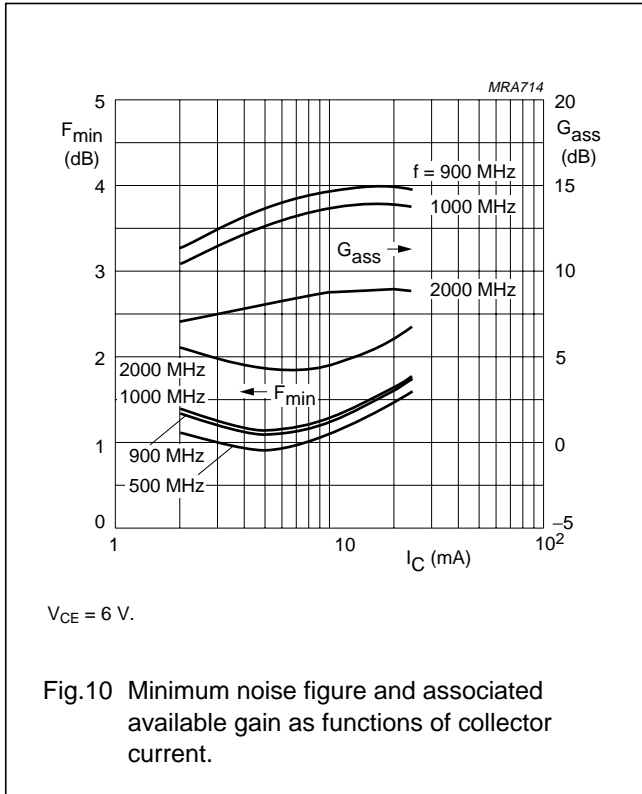

NPN 9 GHz wideband transistor

BFR520

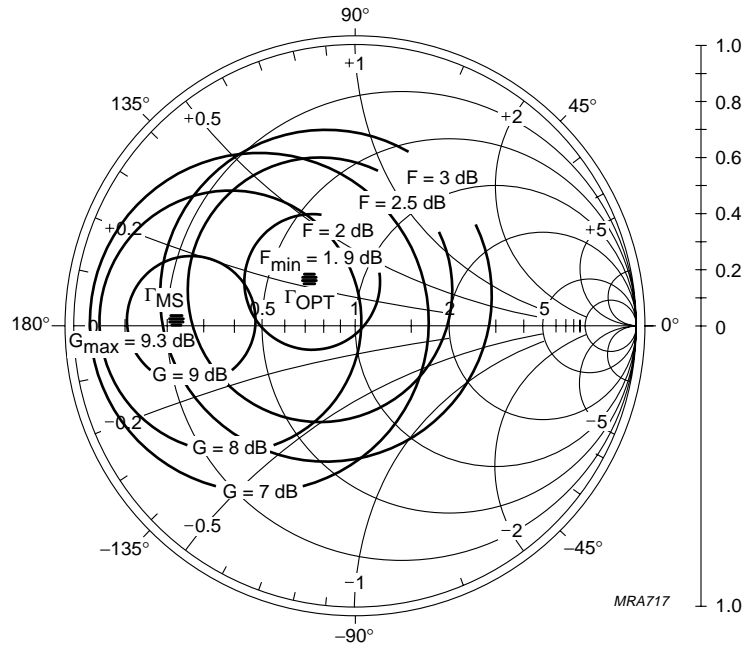

MRA717

$Z_0 = 50 \Omega$.
 $V_{CE} = 6 V$; $I_C = 5 mA$; $f = 2000 MHz$.

Fig.13 Noise circle figure.

NPN 9 GHz wideband transistor

BFR520

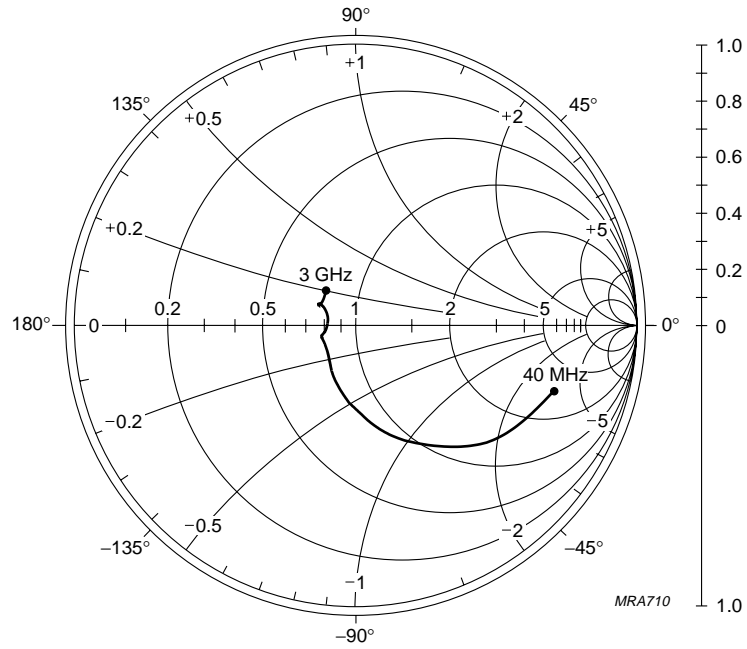

$V_{CE} = 6\text{ V}; I_C = 20\text{ mA}.$
 $Z_0 = 50\ \Omega.$

Fig.14 Common emitter input reflection coefficient (S_{11}).

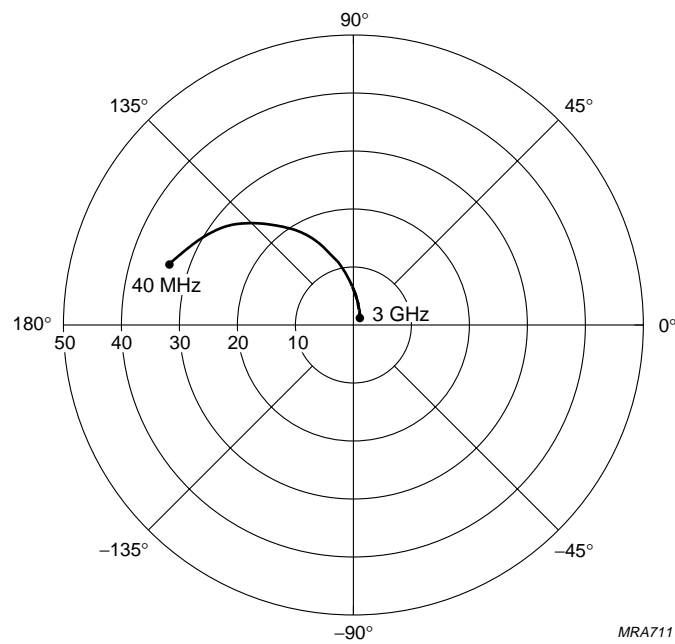

$V_{CE} = 6\text{ V}; I_C = 20\text{ mA}.$

Fig.15 Common emitter forward transmission coefficient (S_{21}).

NPN 9 GHz wideband transistor

BFR520

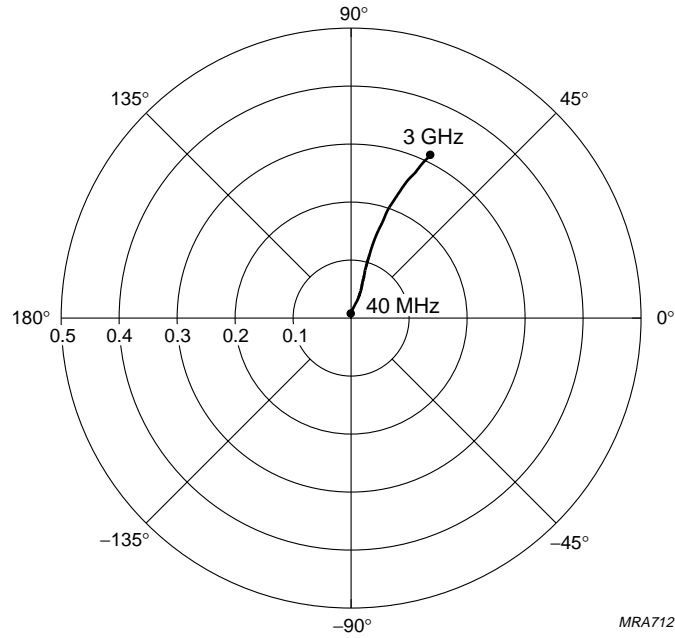

$V_{CE} = 6\text{ V}; I_C = 20\text{ mA.}$

Fig.16 Common emitter reverse transmission coefficient (S_{12}).

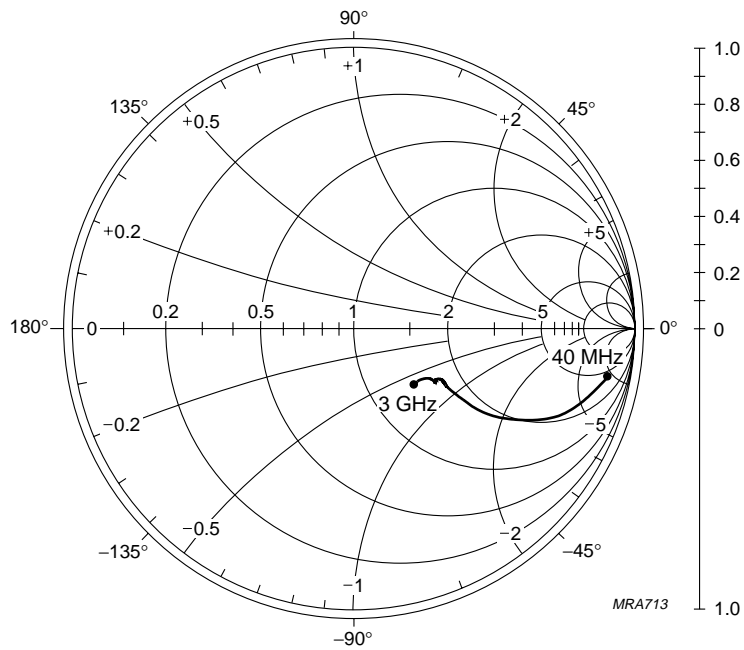

$V_{CE} = 6\text{ V}; I_C = 20\text{ mA.}$
 $Z_0 = 50\ \Omega.$

Fig.17 Common emitter output reflection coefficient (S_{22}).

NPN 9 GHz wideband transistor

BFR520

PACKAGE OUTLINE

Plastic surface mounted package; 3 leads

SOT23

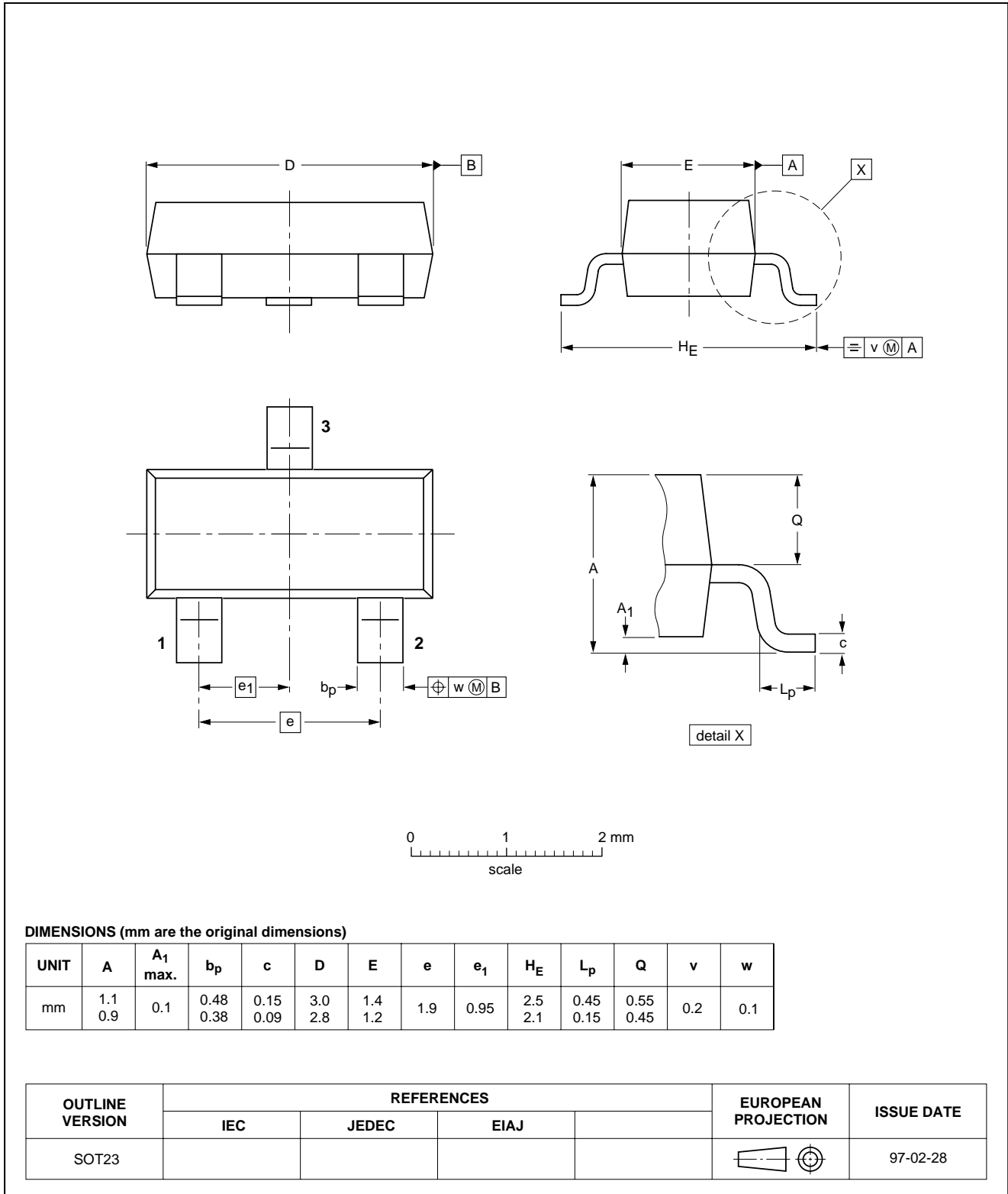

NPN 9 GHz wideband transistor

BFR520

DEFINITIONS

Data Sheet Status	
Objective specification	This data sheet contains target or goal specifications for product development.
Preliminary specification	This data sheet contains preliminary data; supplementary data may be published later.
Product specification	This data sheet contains final product specifications.
Limiting values	
Limiting values given are in accordance with the Absolute Maximum Rating System (IEC 134). Stress above one or more of the limiting values may cause permanent damage to the device. These are stress ratings only and operation of the device at these or at any other conditions above those given in the Characteristics sections of the specification is not implied. Exposure to limiting values for extended periods may affect device reliability.	
Application information	
Where application information is given, it is advisory and does not form part of the specification.	

LIFE SUPPORT APPLICATIONS

These products are not designed for use in life support appliances, devices, or systems where malfunction of these products can reasonably be expected to result in personal injury. Philips customers using or selling these products for use in such applications do so at their own risk and agree to fully indemnify Philips for any damages resulting from such improper use or sale.