

DATA SHEET

BLV25 VHF power transistor

Product specification

August 1986

VHF power transistor

BLV25

DESCRIPTION

N-P-N silicon planar epitaxial transistor primarily for use in v.h.f.-f.m. broadcast transmitters.

FEATURES

- internally matched input for wideband operation and high power gain;
- multi-base structure and diffused emitter ballasting resistors for an optimum temperature profile;
- gold-metallization ensures excellent reliability.

The transistor has a 1/2in 6-lead flange envelope with a ceramic cap. All leads are isolated from the flange.

QUICK REFERENCE DATA

R.F. performance up to $T_h = 25\text{ }^\circ\text{C}$ in an unneutralized common-emitter class-B circuit.

MODE OPERATION	V_{CE} V	f MHz	P_L W	P_S W	G_p dB	η %
narrow band; c.w.	28	108	175	< 17,5	> 10,0	> 65

PIN CONFIGURATION

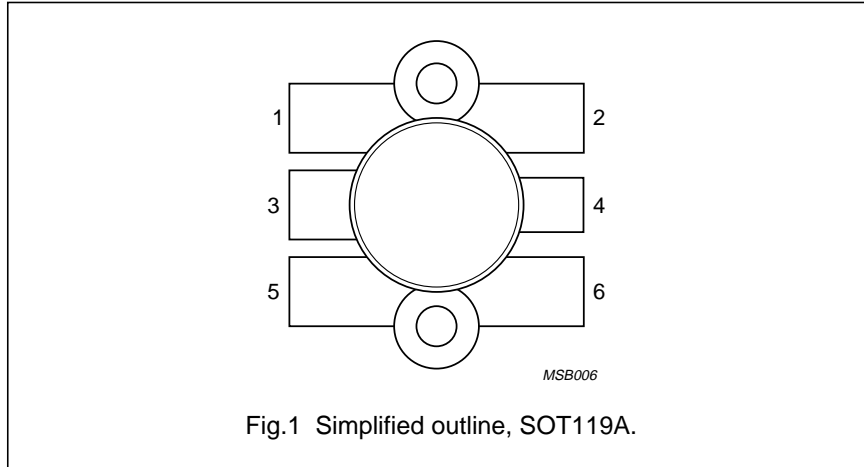

PINNING

PIN	DESCRIPTION
1	emitter
2	emitter
3	base
4	collector
5	emitter
6	emitter

PRODUCT SAFETY This device incorporates beryllium oxide, the dust of which is toxic. The device is entirely safe provided that the BeO disc is not damaged.

VHF power transistor

BLV25

RATINGS

Limiting values in accordance with the Absolute Maximum System (IEC 134)

Collector-emitter voltage

(peak value); $V_{BE} = 0$

open base

Emitter-base voltage (open collector)

Collector current

d.c. or average

(peak value); $f > 1$ MHz

Total power dissipation at $T_{mb} = 25$ °C

R.F. power dissipation ($f > 1$ MHz); $T_{mb} = 25$ °C

R.F. power dissipation ($f > 1$ MHz); $T_h = 70$ °C

Storage temperature

Operating junction temperature

V_{CESM}	max.	65 V
V_{CEO}	max.	33 V
V_{EBO}	max.	4 V
$I_C; I_{C(AV)}$	max.	17,5 A
I_{CM}	max.	35 A
P_{tot} (d.c.)	max.	220 W
P_{tot} (r.f.)	max.	270 W
P_{tot} (r.f.)	max.	146 W
T_{stg}	-65 to	+150 °C
T_j	max.	200 °C

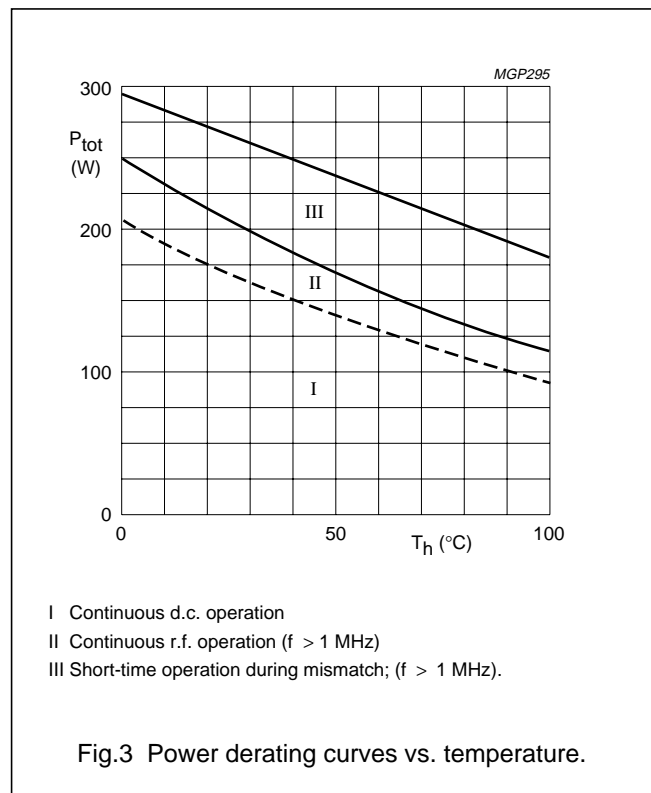
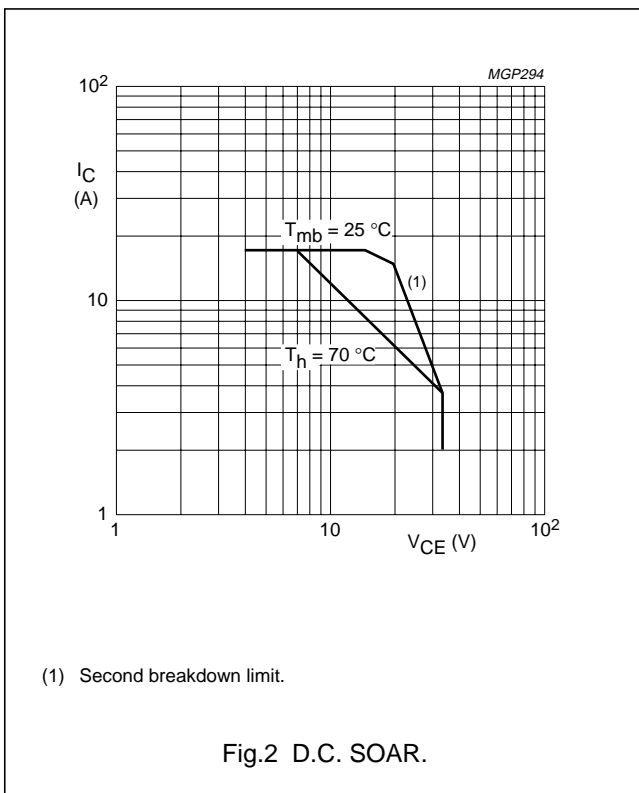

THERMAL RESISTANCE

(dissipation = 150 W; $T_{mb} = 72$ °C, i.e. $T_h = 42$ °C)

From junction to mounting base (d.c. dissipation)

From junction to mounting base (r.f. dissipation)

From mounting base to heatsink

$R_{th\ j-mb(dc)}$	max	0,85 K/W
$R_{th\ j-mb(rf)}$	max	0,60 K/W
$R_{th\ mb-h}$	max	0,2 K/W

VHF power transistor

BLV25

CHARACTERISTICS $T_j = 25\text{ }^\circ\text{C}$

Collector-emitter breakdown voltage

 $V_{BE} = 0; I_C = 50\text{ mA}$ $V_{(BR)CES} > 65\text{ V}$ open base; $I_C = 200\text{ mA}$ $V_{(BR)CEO} > 33\text{ V}$

Emitter-base breakdown voltage

open collector; $I_E = 20\text{ mA}$ $V_{(BR)EBO} > 4\text{ V}$

Collector cut-off current

 $V_{BE} = 0; V_{CE} = 33\text{ V}$ $I_{CES} < 25\text{ mA}$ Second breakdown energy; $L = 25\text{ mH}; f = 50\text{ Hz}$

open base

 $E_{SBO} > 20\text{ mJ}$ $R_{BE} = 10\ \Omega$ $E_{SBR} > 20\text{ mJ}$ D.C. current gain⁽¹⁾ $I_C = 8,5\text{ A}; V_{CE} = 25\text{ V}$ h_{FE} typ. 50
15 to 100Collector-emitter saturation voltage⁽¹⁾ $I_C = 20\text{ A}; I_B = 4,0\text{ A}$ V_{CEsat} typ. 1,6 VTransition frequency at $f = 100\text{ MHz}$ ⁽²⁾ $-I_E = 8,5\text{ A}; V_{CB} = 25\text{ V}$ f_T typ. 600 MHz $-I_E = 20\text{ A}; V_{CB} = 25\text{ V}$ f_T typ. 600 MHzCollector capacitance at $f = 1\text{ MHz}$ $I_E = I_e = 0; V_{CB} = 25\text{ V}$ C_C typ. 275 pFFeedback capacitance at $f = 1\text{ MHz}$ $I_C = 100\text{ mA}; V_{CE} = 25\text{ V}$ C_{re} typ. 155 pF

Collector-flange capacitance

 C_{cf} typ. 3 pF**Notes**

1. Measured under pulse conditions: $t_p \leq 300\ \mu\text{s}; \delta \leq 0,02$.
2. Measured under pulse conditions: $t_p \leq 50\ \mu\text{s}; \delta \leq 0,01$.

VHF power transistor

BLV25

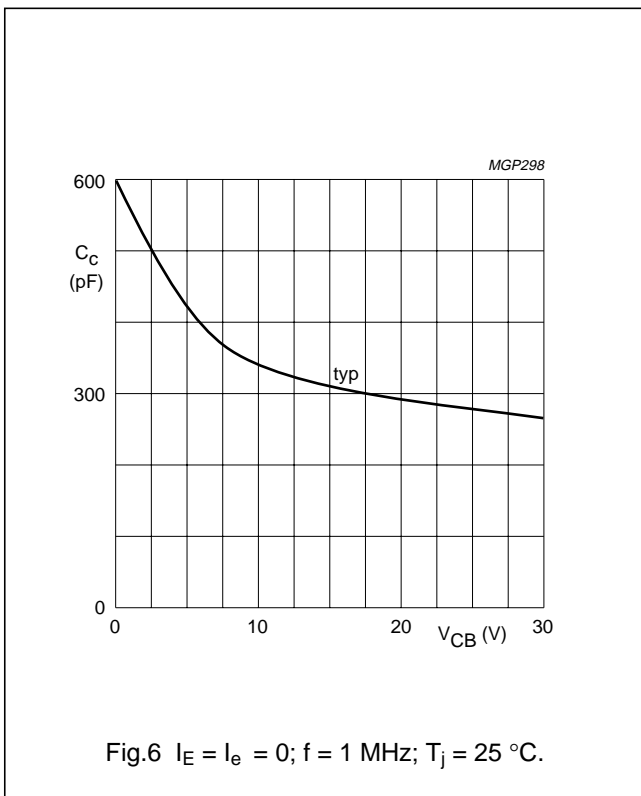
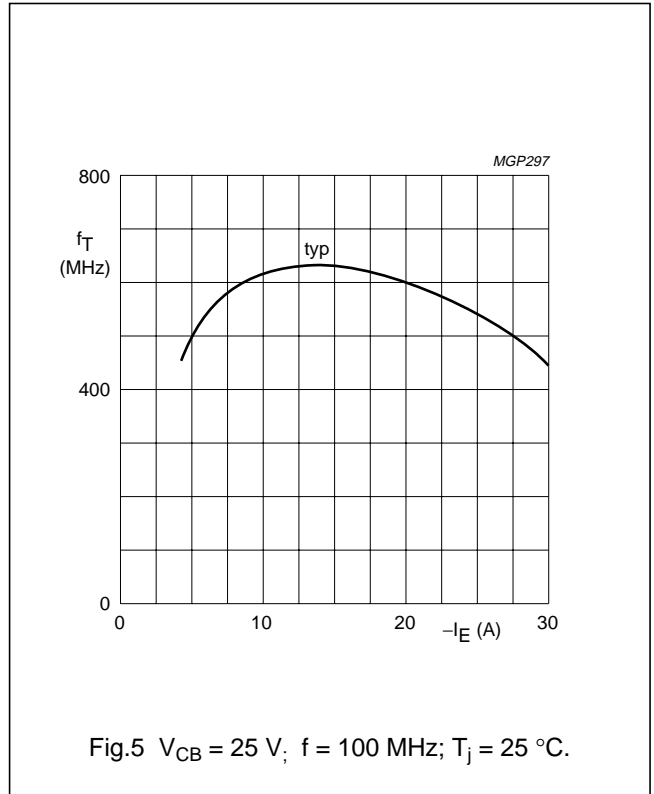
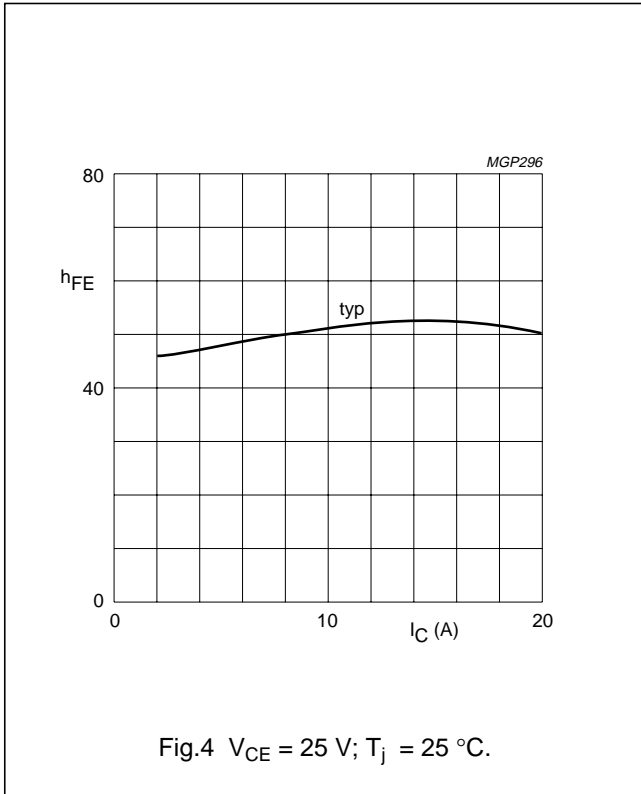

VHF power transistor

BLV25

APPLICATION INFORMATION

R.F. performance in narrow band c.w. operation (common-emitter class-B circuit) $T_h = 25\text{ }^\circ\text{C}$

f MHz	V_{CE} V	P_L W	P_S W	G_p dB	I_C A	η %
108	28	175	< 17,5 typ. 13,9	> 10,0 typ. 11,0	< 9,6 typ. 8,9	> 65 typ. 70

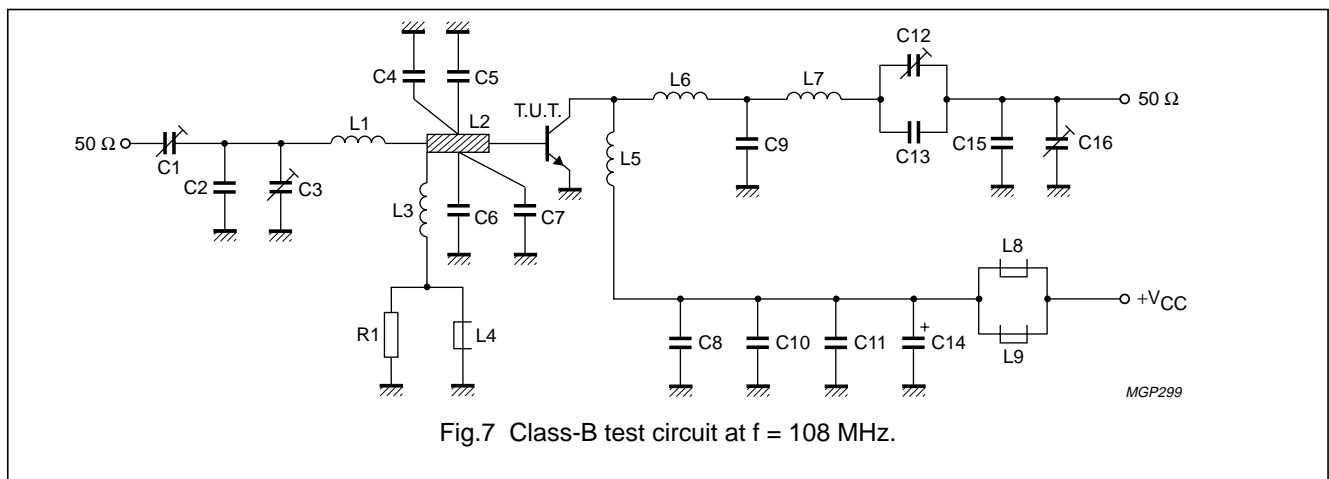
Fig.7 Class-B test circuit at $f = 108\text{ MHz}$.

List of components

C1 = C3 = 7 to 100 pF film dielectric trimmer (cat. no. 2222 809 07015)

C2 = C4 = C5 = C6 = C7 = 100 pF (500 V) multilayer ceramic chip capacitor (ATC⁽¹⁾); except for C2 these capacitors are placed 7 mm from transistor edge

C8 = C10 = 470 pF multilayer ceramic chip capacitor (cat. no. 2222 856 13471)

C9 = C15 = 40 pF, parallel connection of 4 x 10 pF lead feed-through capacitors (cat. no. 2222 702 05109)

C11 = 100 nF multilayer ceramic chip capacitor (cat. no. 2222 852 59104)

C12 = C16 = 7 to 47 pF precision tuning capacitor (cat. no. 2222 805 00174)

C13 = 19 pF, parallel connection of 4 x 4,7 pF lead feed-through capacitors (cat. no. 2222 702 04478)

C14 = 6,8 μF /63 V electrolytic capacitor

L1 = Cu strip (10 mm x 4 mm x 0,5 mm)

L2 = strip on printed-circuit board

L3 = 7 turns closely wound enamelled Cu wire (0,3 mm); int. dia. 3,0 mm; leads 2 x 6 mm

L4 = L8 = L9 = Ferroxcube wide-band h.f. choke, grade 3B (cat. no. 4312 020 36640)

L5 = 3 turns enamelled Cu wire (1,6 mm); int. dia. 8 mm; length 9 mm; leads 2 x 5 mm

L6 = Cu strip (27 mm x 9 mm x 0,5 mm)

L7 = 2 turns enamelled Cu wire (1,6 mm); int. dia. 8 mm; length 9 mm; leads 2 x 10 mm

L2 is strip on a double Cu-clad printed-circuit board with epoxy fibre-glass dielectric, thickness 1/16 in.

R1 = 10 Ω carbon resistor

Note

1. ATC means American Technical Ceramics.

VHF power transistor

BLV25

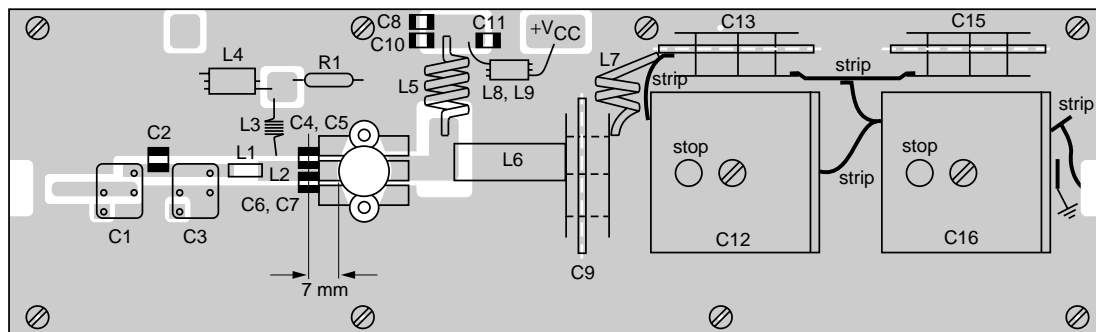
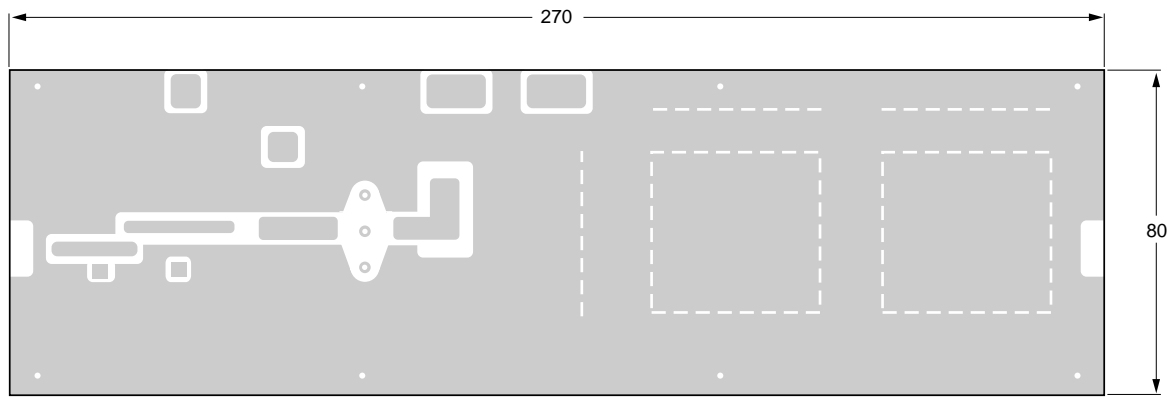

MGP300

The circuit and the components are on one side of the epoxy fibre-glass board, the other side is unetched copper to serve as a ground-plane. Earth connections are made by means of fixing screws. Additionally copper strips are used under the emitters and at the input and output to provide direct contact between the copper on the component side and the ground-plane.

Fig.8 Component layout and printed-circuit board for 108 MHz class-B test circuit.

VHF power transistor

BLV25

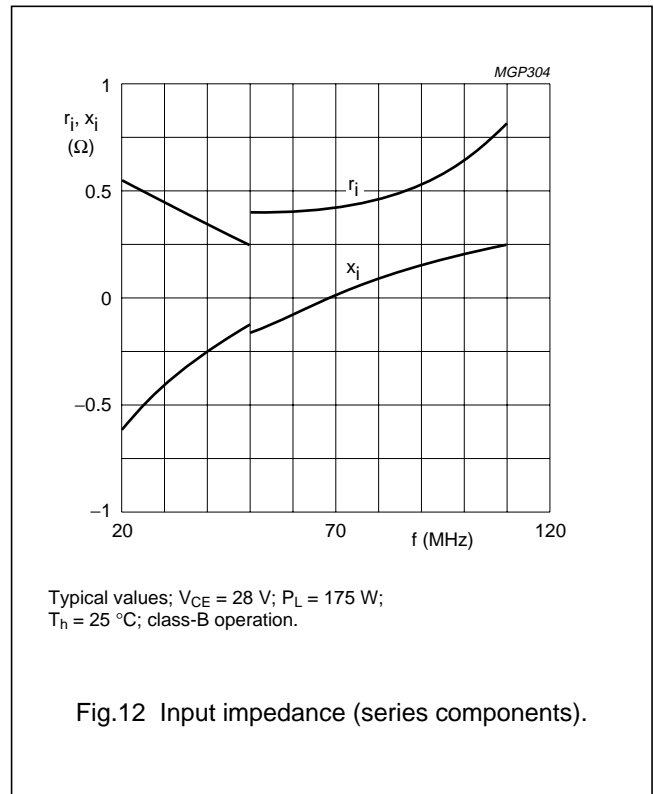
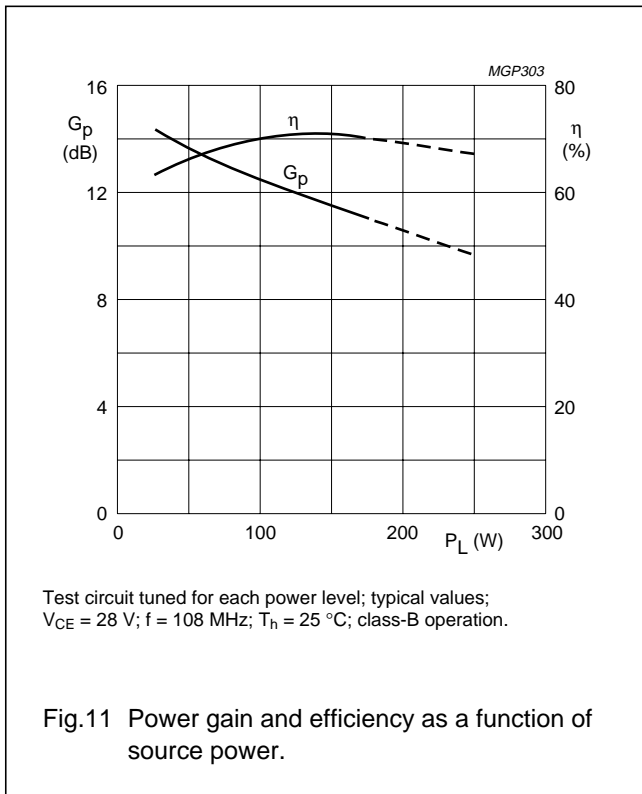
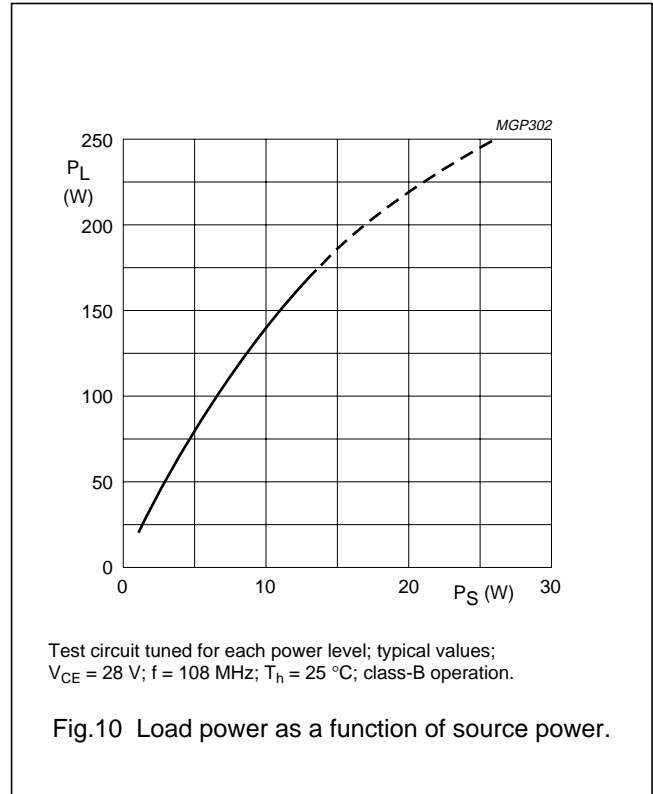
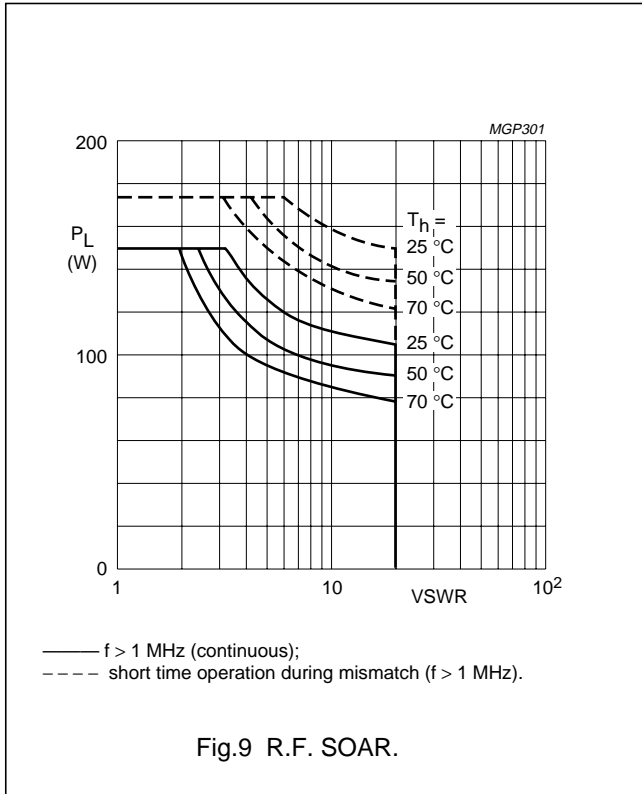

VHF power transistor

BLV25

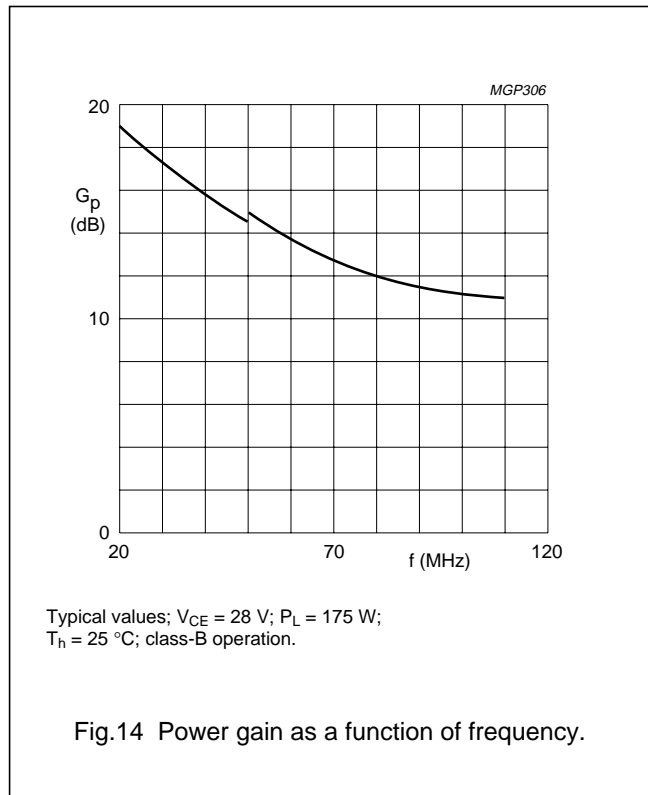
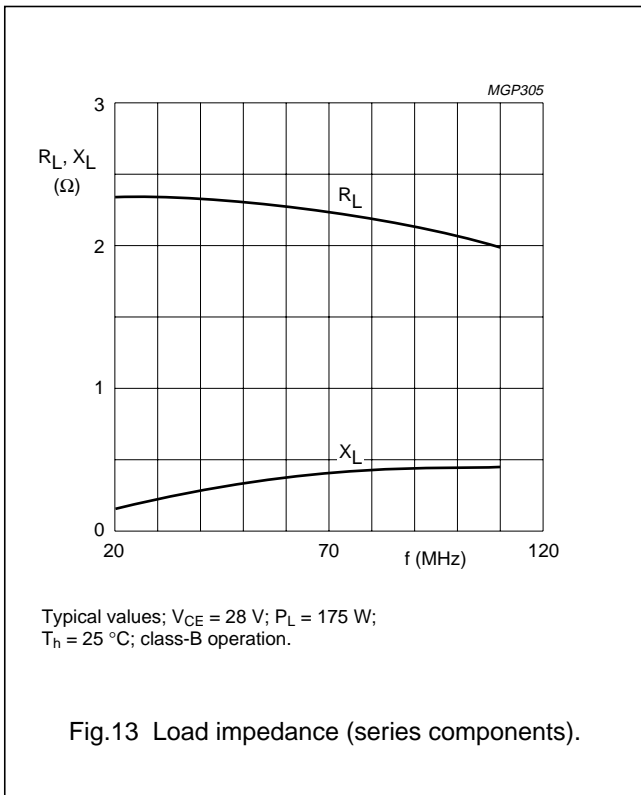

OPERATING NOTE for Figs 12, 13 and 14:
 Below 50 MHz a base-emitter resistor of 4,7 Ω is recommended to avoid oscillation. This resistor must be effective for r.f. only.

VHF power transistor

BLV25

PACKAGE OUTLINE

Flanged ceramic package; 2 mounting holes; 6 leads

SOT119A

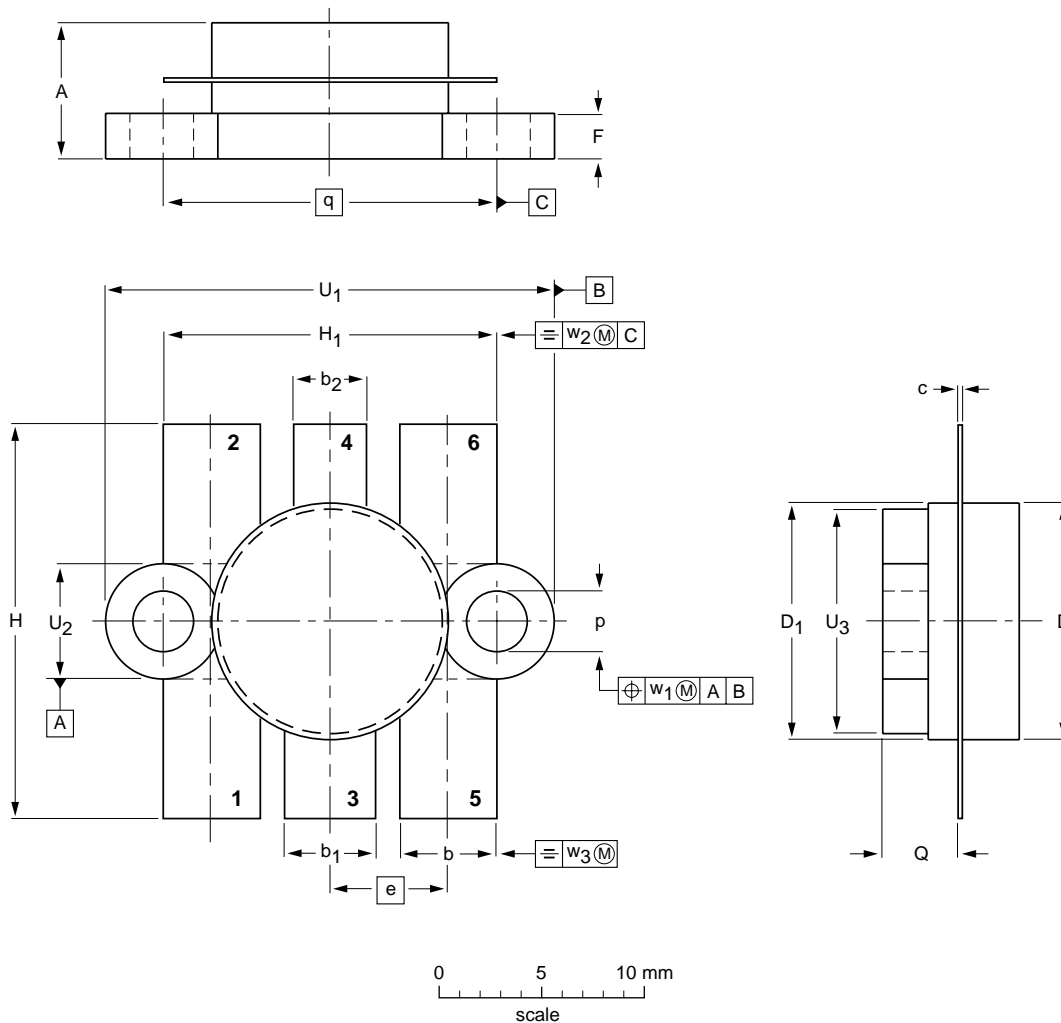

DIMENSIONS (millimetre dimensions are derived from the original inch dimensions)

UNIT	A	b	b ₁	b ₂	c	D	D ₁	e	F	H	H ₁	p	Q	q	U ₁	U ₂	U ₃	w ₁	w ₂	w ₃
mm	7.39 6.32	5.59 5.33	5.34 5.08	4.07 3.81	0.18 0.07	12.86 12.59	12.83 12.57	6.48	2.54 2.28	22.10 21.08	18.55 18.28	3.31 2.97	4.58 3.98	18.42	25.23 23.95	6.48 6.07	12.76 12.06	0.51	1.02	0.26
inches	0.291 0.249	0.220 0.210	0.210 0.200	0.160 0.150	0.007 0.003	0.505 0.496	0.505 0.495	0.255	0.100 0.090	0.870 0.830	0.730 0.720	0.130 0.117	0.180 0.157	0.725	0.993 0.943	0.255 0.239	0.502 0.475	0.02	0.04	0.01

OUTLINE VERSION	REFERENCES				EUROPEAN PROJECTION	ISSUE DATE
	IEC	JEDEC	EIAJ			
SOT119A						97-06-28

VHF power transistor

BLV25

DEFINITIONS

Data Sheet Status	
Objective specification	This data sheet contains target or goal specifications for product development.
Preliminary specification	This data sheet contains preliminary data; supplementary data may be published later.
Product specification	This data sheet contains final product specifications.
Limiting values	
Limiting values given are in accordance with the Absolute Maximum Rating System (IEC 134). Stress above one or more of the limiting values may cause permanent damage to the device. These are stress ratings only and operation of the device at these or at any other conditions above those given in the Characteristics sections of the specification is not implied. Exposure to limiting values for extended periods may affect device reliability.	
Application information	
Where application information is given, it is advisory and does not form part of the specification.	

LIFE SUPPORT APPLICATIONS

These products are not designed for use in life support appliances, devices, or systems where malfunction of these products can reasonably be expected to result in personal injury. Philips customers using or selling these products for use in such applications do so at their own risk and agree to fully indemnify Philips for any damages resulting from such improper use or sale.