

**Dual rectifier diodes  
ultrafast**

**BYV44 series**

**FEATURES**

- Low forward volt drop
- Fast switching
- Soft recovery characteristic
- High thermal cycling performance
- Low thermal resistance

**SYMBOL**

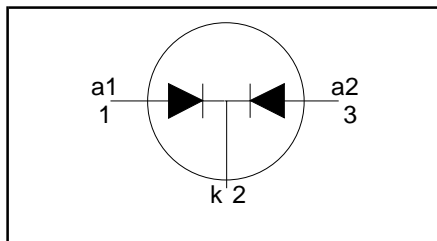

**QUICK REFERENCE DATA**

|  |
|--|
| $V_R = 300\text{ V} / 400\text{ V} / 500\text{ V}$ |
| $V_F \leq 1.12\text{ V}$                           |
| $I_{O(AV)} = 30\text{ A}$                          |
| $t_{rr} \leq 60\text{ ns}$                         |

**GENERAL DESCRIPTION**

Dual, common cathode, ultra-fast, epitaxial rectifier diodes intended for use as output rectifiers in high frequency switched mode power supplies.

The BYV44 series is supplied in the conventional leaded SOT78 (TO220AB) package.

**PINNING**

| PIN | DESCRIPTION |
|-----|-------------|
| 1   | anode 1     |
| 2   | cathode     |
| 3   | anode 2     |
| tab | cathode     |

**SOT78 (TO220AB)**

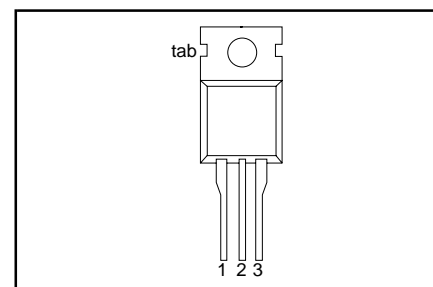

**LIMITING VALUES**

Limiting values in accordance with the Absolute Maximum System (IEC 134).

| SYMBOL      | PARAMETER  | CONDITIONS   | MIN. | MAX.        |             |             | UNIT             |
|-------------|--|--|------|-------------|-------------|-------------|------------------|
| $V_{RRM}$   | Peak repetitive reverse voltage  | <b>BYV44</b><br>$T_{mb} \leq 136\text{ }^\circ\text{C}$                                  | -    | <b>-300</b> | <b>-400</b> | <b>-500</b> | V                |
| $V_{RWM}$   | Crest working reverse voltage  |  | -    | 300         | 400         | 500         | V                |
| $V_R$       | Continuous reverse voltage   |  | -    | 300         | 400         | 500         | V                |
| $I_{O(AV)}$ | Average rectified output current (both diodes conducting) <sup>1</sup> | square wave; $\delta = 0.5$ ;<br>$T_{mb} \leq 94\text{ }^\circ\text{C}$                  | -    | 30          |             |             | A                |
| $I_{FRM}$   | Repetitive peak forward current per diode                              | $t = 25\text{ }\mu\text{s}$ ; $\delta = 0.5$ ;<br>$T_{mb} \leq 94\text{ }^\circ\text{C}$ | -    | 30          |             |             | A                |
| $I_{FSM}$   | Non-repetitive peak forward current per diode.                         | $t = 10\text{ ms}$<br>$t = 8.3\text{ ms}$<br>sinusoidal; with reapplied $V_{RRM(max)}$   | -    | 150         |             |             | A                |
| $T_{stg}$   | Storage temperature  |  | -40  | 150         |             |             | $^\circ\text{C}$ |
| $T_j$       | Operating junction temperature   |  | -    | 150         |             |             | $^\circ\text{C}$ |

**THERMAL RESISTANCES**

| SYMBOL         | PARAMETER                               | CONDITIONS                             | MIN. | TYP. | MAX. | UNIT |
|----------------|---|--|------|------|------|------|
| $R_{th\ j-hs}$ | Thermal resistance junction to heatsink | per diode                              | -    | -    | 2.4  | K/W  |
| $R_{th\ j-a}$  | Thermal resistance junction to ambient  | both diodes conducting<br>in free air. | -    | -    | 1.4  | K/W  |
|                |   |  | -    | 60   | -    | K/W  |

<sup>1</sup> Neglecting switching and reverse current losses.

For output currents in excess of 20 A, the cathode connection should be made to the metal mounting tab.

Dual rectifier diodes  
ultrafast

BYV44 series

**ELECTRICAL CHARACTERISTICS**

characteristics are per diode at  $T_j = 25\text{ }^\circ\text{C}$  unless otherwise stated

| SYMBOL    | PARAMETER                     | CONDITIONS  | MIN. | TYP. | MAX. | UNIT          |
|-----------|-------------------------------|---|------|------|------|---------------|
| $V_F$     | Forward voltage               | $I_F = 15\text{ A}; T_j = 150\text{ }^\circ\text{C}$  | -    | 0.95 | 1.12 | V             |
|           |                               | $I_F = 15\text{ A}$   | -    | 1.08 | 1.25 | V             |
|           |                               | $I_F = 30\text{ A}$   | -    | 1.15 | 1.36 | V             |
| $I_R$     | Reverse current               | $V_R = V_{RRM}$   | -    | 10   | 50   | $\mu\text{A}$ |
| $Q_s$     | Reverse recovery charge       | $V_R = V_{RRM}; T_j = 100\text{ }^\circ\text{C}$  | -    | 0.3  | 0.8  | mA            |
|           |                               | $I_F = 2\text{ A to } V_R \geq 30\text{ V};$<br>$di_F/dt = 20\text{ A}/\mu\text{s}$                                   | -    | 40   | 60   | nC            |
| $t_{rr}$  | Reverse recovery time         | $I_F = 1\text{ A to } V_R \geq 30\text{ V};$<br>$di_F/dt = 100\text{ A}/\mu\text{s}$                                  | -    | 50   | 60   | ns            |
| $I_{rrm}$ | Peak reverse recovery current | $I_F = 10\text{ A to } V_R \geq 30\text{ V};$<br>$di_F/dt = 50\text{ A}/\mu\text{s}; T_j = 100\text{ }^\circ\text{C}$ | -    | 4.2  | 5.2  | A             |
| $V_{fr}$  | Forward recovery voltage      | $I_F = 10\text{ A}; di_F/dt = 10\text{ A}/\mu\text{s}$  | -    | 2.5  | -    | V             |

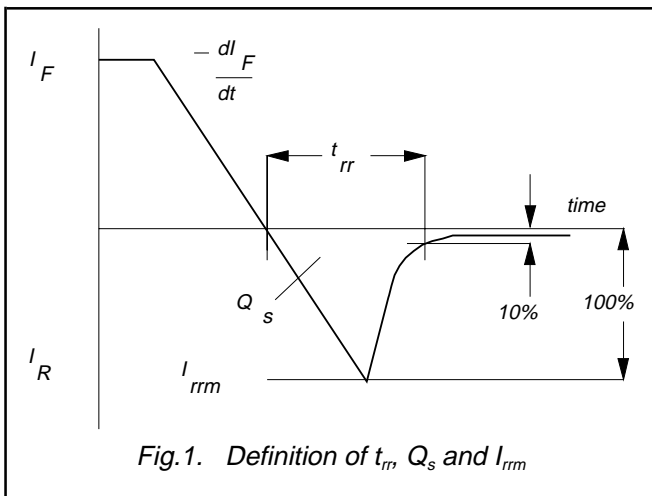

Fig.1. Definition of  $t_{rr}$ ,  $Q_s$  and  $I_{rrm}$

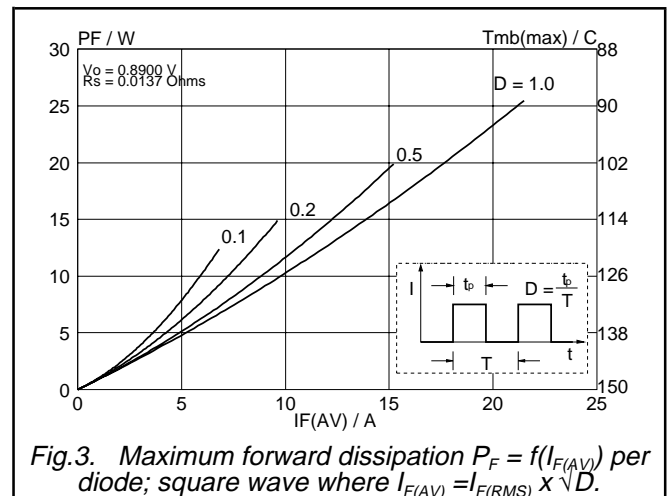

Fig.3. Maximum forward dissipation  $P_F = f(I_{F(AV)})$  per diode; square wave where  $I_{F(AV)} = I_{F(RMS)} \times \sqrt{D}$ .

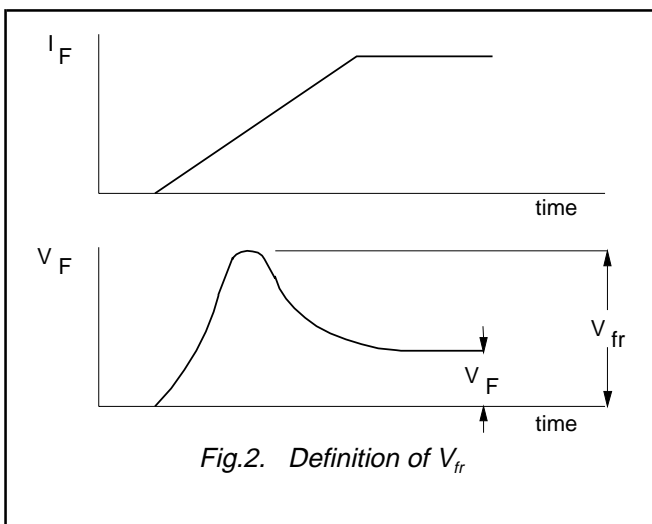

Fig.2. Definition of  $V_{fr}$

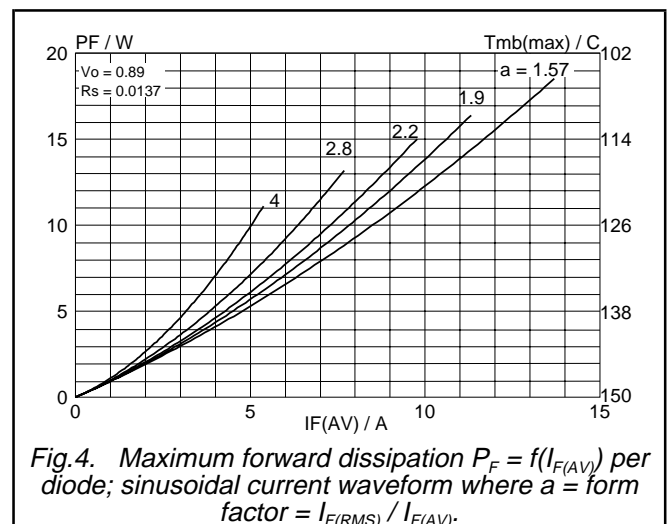

Fig.4. Maximum forward dissipation  $P_F = f(I_{F(AV)})$  per diode; sinusoidal current waveform where  $a = \text{form factor} = I_{F(RMS)} / I_{F(AV)}$ .

Dual rectifier diodes  
ultrafast

BYV44 series

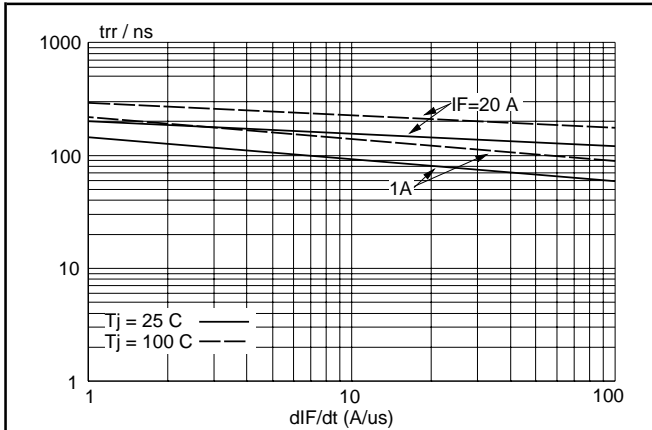

Fig.5. Maximum  $t_{rr}$  at  $T_j = 25^\circ\text{C}$  and  $100^\circ\text{C}$ ; per diode

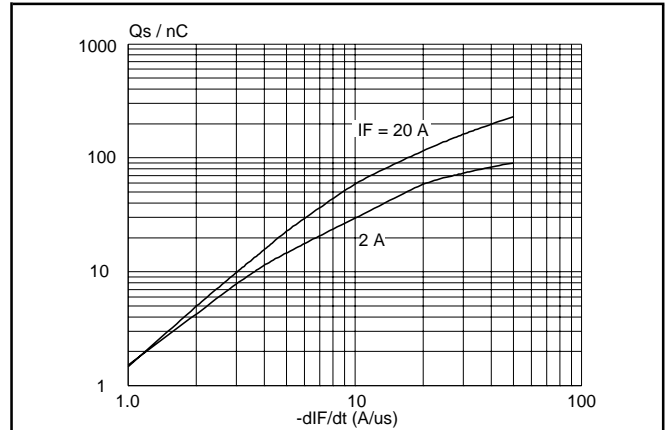

Fig.8. Maximum  $Q_s$  at  $T_j = 25^\circ\text{C}$ ; per diode

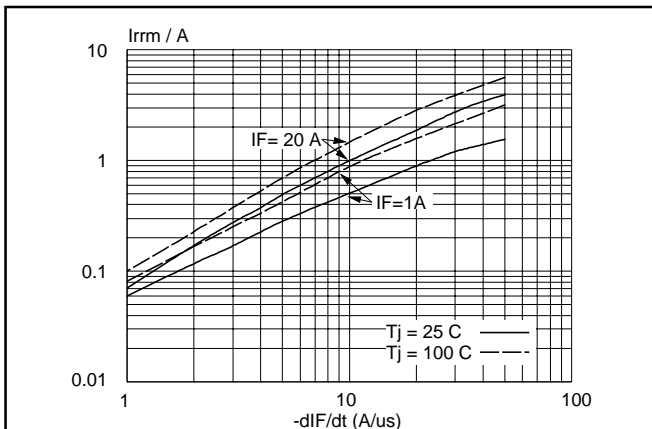

Fig.6. Maximum  $I_{rrm}$  at  $T_j = 25^\circ\text{C}$  and  $100^\circ\text{C}$ ; per diode

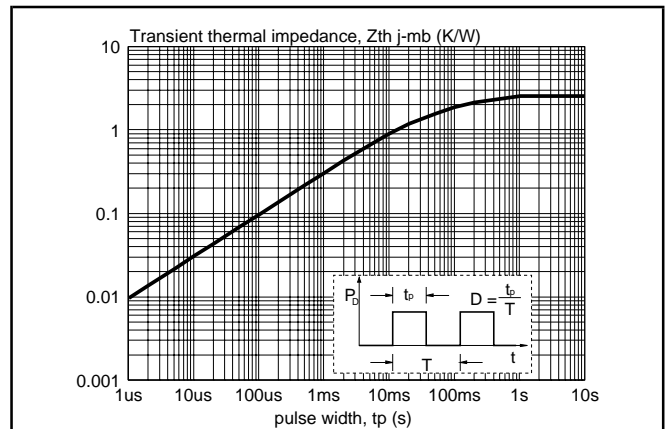

Fig.9. Transient thermal impedance per diode  $Z_{th\ j-mb} = f(t_p)$

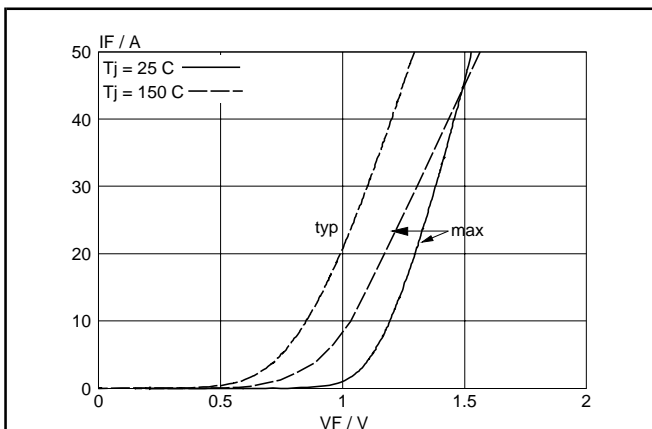

Fig.7. Typical and maximum forward characteristic  $I_F = f(V_F)$ ; parameter  $T_j$

Dual rectifier diodes  
ultrafast

BYV44 series

**MECHANICAL DATA**

Dimensions in mm

Net Mass: 2 g

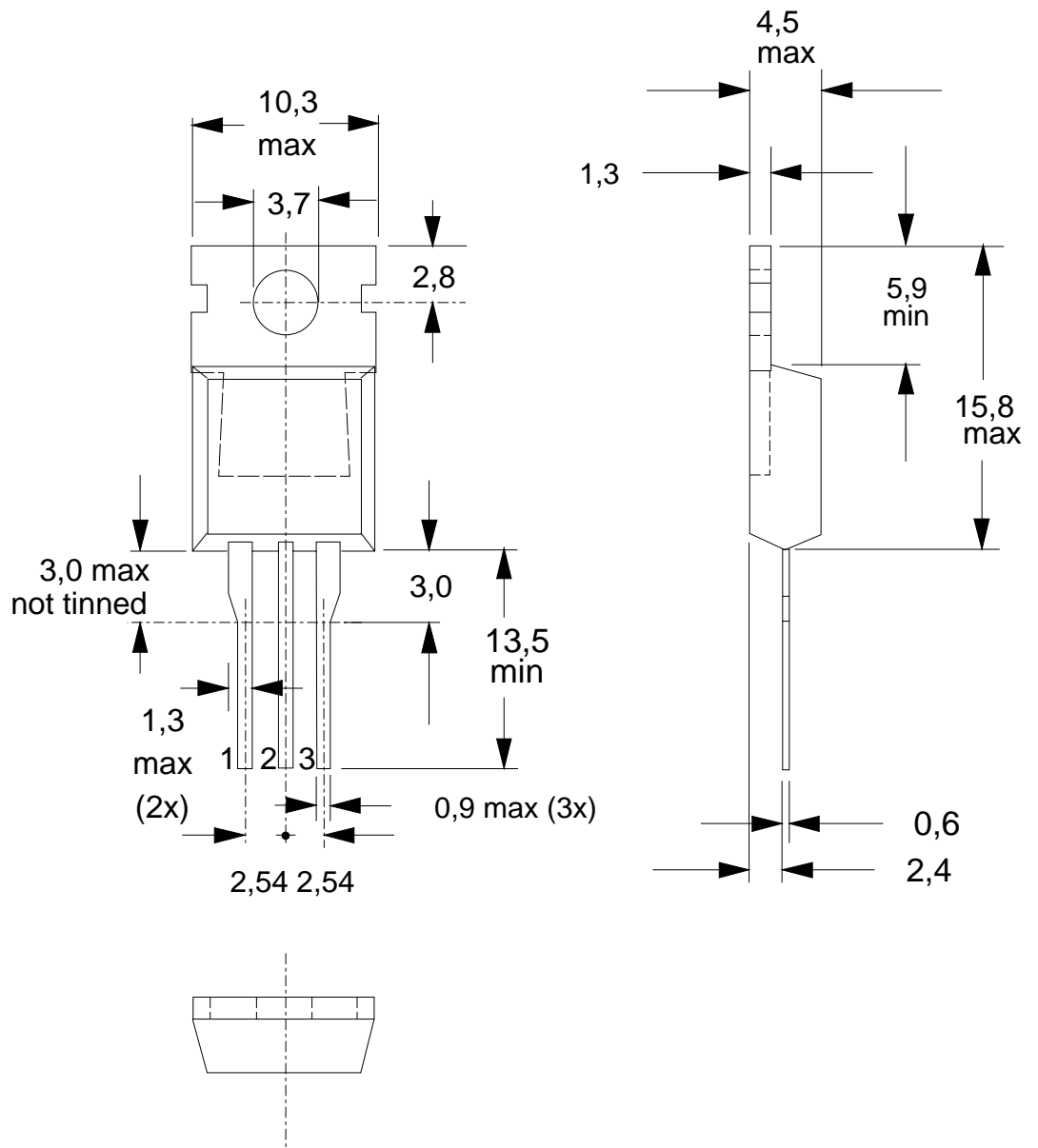

Fig.10. SOT78 (TO220AB); pin 2 connected to mounting base.

**Notes**

1. Refer to mounting instructions for SOT78 (TO220) envelopes.
2. Epoxy meets UL94 V0 at 1/8".

---

**Dual rectifier diodes  
ultrafast**

---

**BYV44 series****DEFINITIONS**

|  |   |
|--|---|
| <b>Data sheet status</b>   |   |
| Objective specification  | This data sheet contains target or goal specifications for product development.       |
| Preliminary specification  | This data sheet contains preliminary data; supplementary data may be published later. |
| Product specification  | This data sheet contains final product specifications.                                |
| <b>Limiting values</b>   |   |
| Limiting values are given in accordance with the Absolute Maximum Rating System (IEC 134). Stress above one or more of the limiting values may cause permanent damage to the device. These are stress ratings only and operation of the device at these or at any other conditions above those given in the Characteristics sections of this specification is not implied. Exposure to limiting values for extended periods may affect device reliability. |   |
| <b>Application information</b>   |   |
| Where application information is given, it is advisory and does not form part of the specification.  |   |
| <b>© Philips Electronics N.V. 1998</b>   |   |
| All rights are reserved. Reproduction in whole or in part is prohibited without the prior written consent of the copyright owner.  |   |
| The information presented in this document does not form part of any quotation or contract, it is believed to be accurate and reliable and may be changed without notice. No liability will be accepted by the publisher for any consequence of its use. Publication thereof does not convey nor imply any license under patent or other industrial or intellectual property rights.   |   |

**LIFE SUPPORT APPLICATIONS**

These products are not designed for use in life support appliances, devices or systems where malfunction of these products can be reasonably expected to result in personal injury. Philips customers using or selling these products for use in such applications do so at their own risk and agree to fully indemnify Philips for any damages resulting from such improper use or sale.