

## N-channel enhancement mode Logic level TrenchMOS™ transistor

IRLZ34N

### GENERAL DESCRIPTION

N-channel enhancement mode logic level field-effect power transistor in a plastic envelope using 'trench' technology. The device features very low on-state resistance and has integral zener diodes giving ESD protection up to 2kV. It is intended for use in switched mode power supplies and general purpose switching applications.

### QUICK REFERENCE DATA

SYMBOL	PARAMETER	MAX.	UNIT
$V_{DS}$	Drain-source voltage	55	V
$I_D$	Drain current (DC)	30	A
$P_{tot}$	Total power dissipation	68	W
$T_j$	Junction temperature	175	°C
$R_{DS(ON)}$	Drain-source on-state resistance $V_{GS} = 10\text{ V}$	35	mΩ

### PINNING - TO220AB

PIN	DESCRIPTION
1	gate
2	drain
3	source
tab	drain

### PIN CONFIGURATION

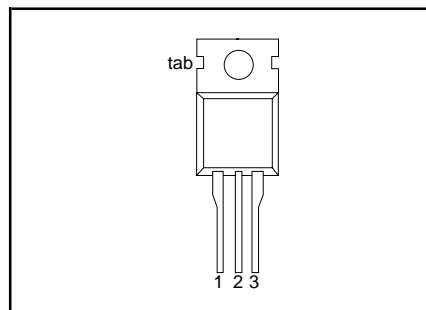

### SYMBOL

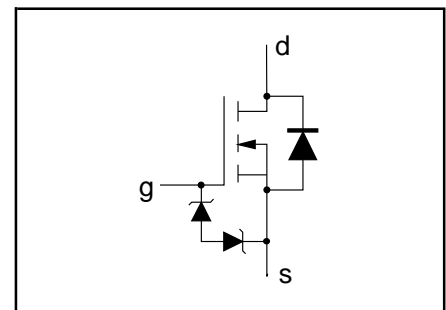

### LIMITING VALUES

Limiting values in accordance with the Absolute Maximum System (IEC 134)

SYMBOL	PARAMETER	CONDITIONS	MIN.	MAX.	UNIT
$V_{DSS}$	Drain-source voltage	$T_j = 25\text{ °C to }175\text{ °C}$	-	55	V
$V_{DGR}$	Drain-gate voltage	$T_j = 25\text{ °C to }175\text{ °C}; R_{GS} = 20\text{ k}\Omega$	-	55	V
$V_{GS}$	Gate-source voltage		-	$\pm 13$	V
$I_D$	Continuous drain current	$T_{mb} = 25\text{ °C}$	-	30	A
		$T_{mb} = 100\text{ °C}$	-	21	A
$I_{DM}$	Pulsed drain current	$T_{mb} = 25\text{ °C}$	-	110	A
$P_D$	Total power dissipation	$T_{mb} = 25\text{ °C}$	-	68	W
$T_j, T_{stg}$	Operating junction and storage temperature		-55	175	°C

### THERMAL RESISTANCES

SYMBOL	PARAMETER	CONDITIONS	TYP.	MAX.	UNIT
$R_{th\ j-mb}$	Thermal resistance junction to mounting base		-	2.2	K/W
$R_{th\ j-a}$	Thermal resistance junction to ambient		60	-	K/W

### ESD LIMITING VALUE

SYMBOL	PARAMETER	CONDITIONS	MIN.	MAX.	UNIT
$V_C$	Electrostatic discharge capacitor voltage, all pins	Human body model (100 pF, 1.5 kΩ)	-	2	kV

## N-channel enhancement mode Logic level TrenchMOS™ transistor

IRLZ34N

### ELECTRICAL CHARACTERISTICS

T<sub>j</sub> = 25 °C unless otherwise specified

SYMBOL	PARAMETER	CONDITIONS	MIN.	TYP.	MAX.	UNIT
V <sub>(BR)DSS</sub>	Drain-source breakdown voltage	V <sub>GS</sub> = 0 V; I <sub>D</sub> = 0.25 mA; T <sub>j</sub> = -55 °C	55 50	- -	- -	V V
V <sub>(BR)GSS</sub>	Gate-source breakdown voltage	I <sub>G</sub> = ±1 mA;	10	-	-	V
V <sub>GS(TO)</sub>	Gate threshold voltage	V <sub>DS</sub> = V <sub>GS</sub> ; I <sub>D</sub> = 1 mA T <sub>j</sub> = 175 °C T <sub>j</sub> = -55 °C	1.0 0.5 -	1.5 - -	2.0 - 2.3	V V V
R <sub>DS(ON)</sub>	Drain-source on-state resistance	V <sub>GS</sub> = 5 V; I <sub>D</sub> = 17 A V <sub>GS</sub> = 10 V; I <sub>D</sub> = 17 A T <sub>j</sub> = 175 °C	- - -	28 26 -	46 35 74	mΩ mΩ mΩ
g <sub>fs</sub>	Forward transconductance	V <sub>DS</sub> = 25 V; I <sub>D</sub> = 15 A	12	40	-	S
I <sub>GSS</sub>	Gate source leakage current	V <sub>GS</sub> = ±5 V; V <sub>DS</sub> = 0 V T <sub>j</sub> = 175 °C	- -	0.02 -	1 20	μA μA
I <sub>DSS</sub>	Zero gate voltage drain current	V <sub>DS</sub> = 55 V; V <sub>GS</sub> = 0 V; T <sub>j</sub> = 175 °C	- -	0.05 -	10 500	μA μA
Q <sub>g(tot)</sub>	Total gate charge	I <sub>D</sub> = 30 A; V <sub>DD</sub> = 44 V; V <sub>GS</sub> = 5 V	-	22.5	-	nC
Q <sub>gs</sub>	Gate-source charge		-	6	-	nC
Q <sub>gd</sub>	Gate-drain (Miller) charge		-	11	-	nC
t <sub>d on</sub>	Turn-on delay time	V <sub>DD</sub> = 30 V; I <sub>D</sub> = 25 A;	-	14	21	ns
t <sub>r</sub>	Turn-on rise time	V <sub>GS</sub> = 5 V; R <sub>G</sub> = 10 Ω	-	77	110	ns
t <sub>d off</sub>	Turn-off delay time	Resistive load	-	55	80	ns
t <sub>f</sub>	Turn-off fall time		-	48	65	ns
L <sub>d</sub>	Internal drain inductance	Measured from tab to centre of die	-	3.5	-	nH
L <sub>d</sub>	Internal drain inductance	Measured from drain lead to centre of die (SOT78 package only)	-	4.5	-	nH
L <sub>s</sub>	Internal source inductance	Measured from source lead to source bond pad	-	7.5	-	nH
C <sub>ISS</sub>	Input capacitance	V <sub>GS</sub> = 0 V; V <sub>DS</sub> = 25 V; f = 1 MHz	-	1050	1400	pF
C <sub>OSS</sub>	Output capacitance		-	205	245	pF
C <sub>rSS</sub>	Feedback capacitance		-	113	150	pF

### REVERSE DIODE LIMITING VALUES AND CHARACTERISTICS

T<sub>j</sub> = 25 °C unless otherwise specified

SYMBOL	PARAMETER	CONDITIONS	MIN.	TYP.	MAX.	UNIT
I <sub>S</sub>	Continuous source current (body diode)		-	-	30	A
I <sub>SM</sub>	Pulsed source current (body diode)		-	-	110	A
V <sub>SD</sub>	Diode forward voltage	I <sub>F</sub> = 25 A; V <sub>GS</sub> = 0 V I <sub>F</sub> = 34 A; V <sub>GS</sub> = 0 V	- -	0.95 1.0	1.2 -	V V
t <sub>rr</sub>	Reverse recovery time	I <sub>F</sub> = 34 A; -di <sub>F</sub> /dt = 100 A/μs;	-	40	-	ns
Q <sub>rr</sub>	Reverse recovery charge	V <sub>GS</sub> = -10 V; V <sub>R</sub> = 30 V	-	0.16	-	μC

N-channel enhancement mode  
Logic level TrenchMOS™ transistor

IRLZ34N

**AVALANCHE LIMITING VALUE**

SYMBOL	PARAMETER	CONDITIONS	MIN.	MAX.	UNIT
$W_{DSS}$	Drain-source non-repetitive unclamped inductive turn-off energy	$I_D = 20\text{ A}; V_{DD} \leq 25\text{ V}; V_{GS} = 5\text{ V}; R_{GS} = 50\ \Omega; T_{mb} = 25\text{ }^\circ\text{C}$	-	45	mJ

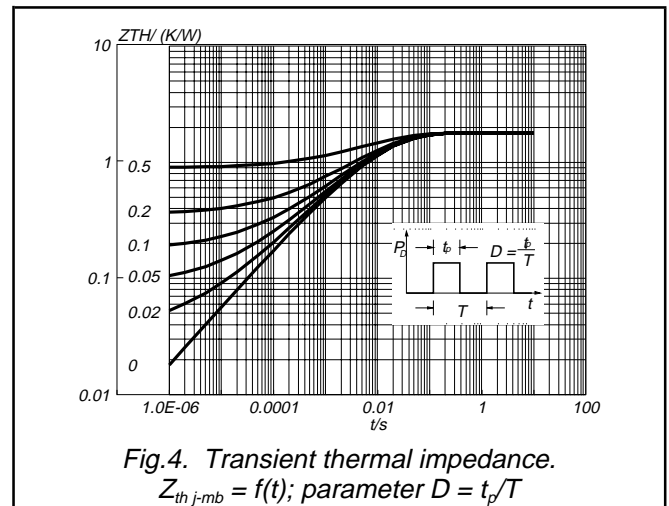
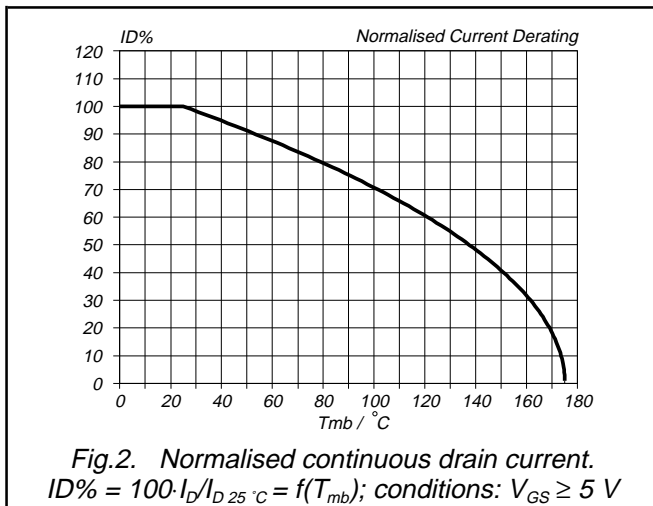
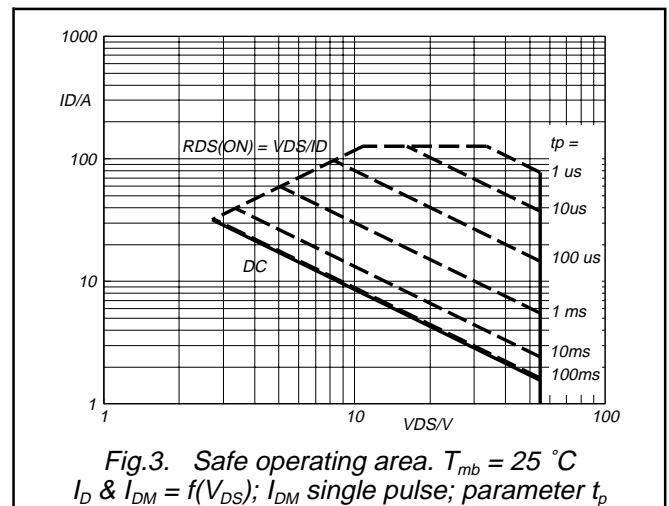
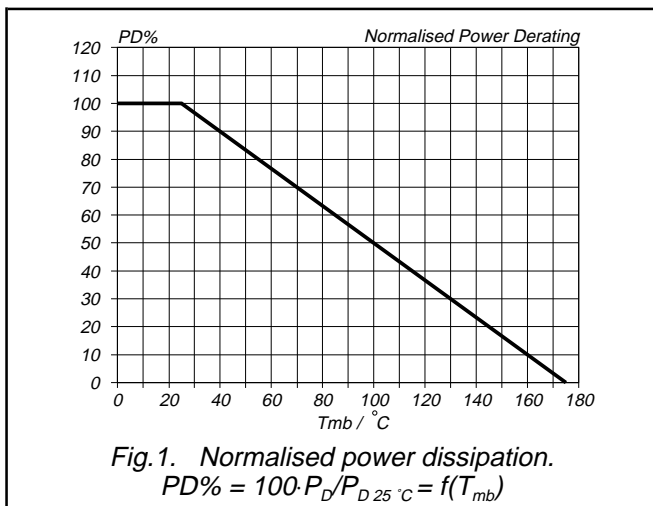

N-channel enhancement mode  
Logic level TrenchMOS™ transistor

IRLZ34N

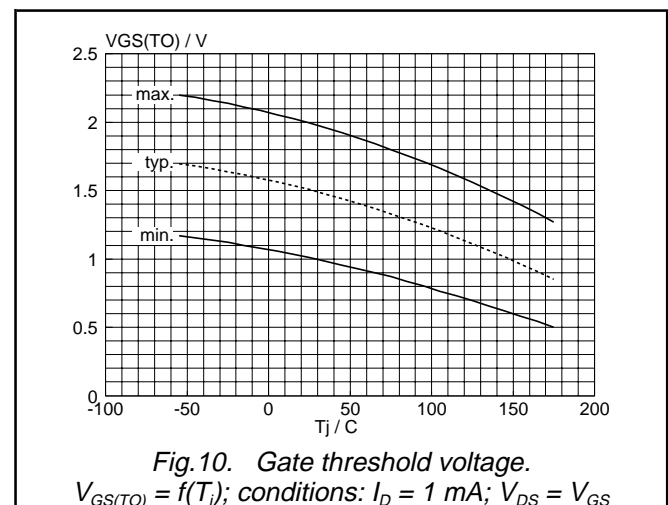
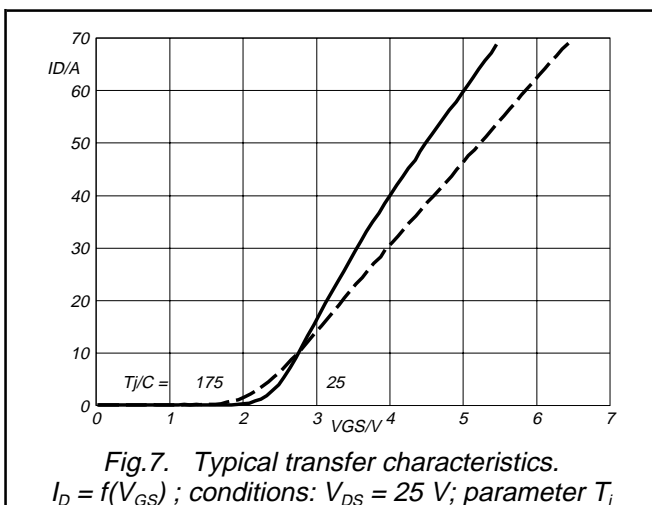
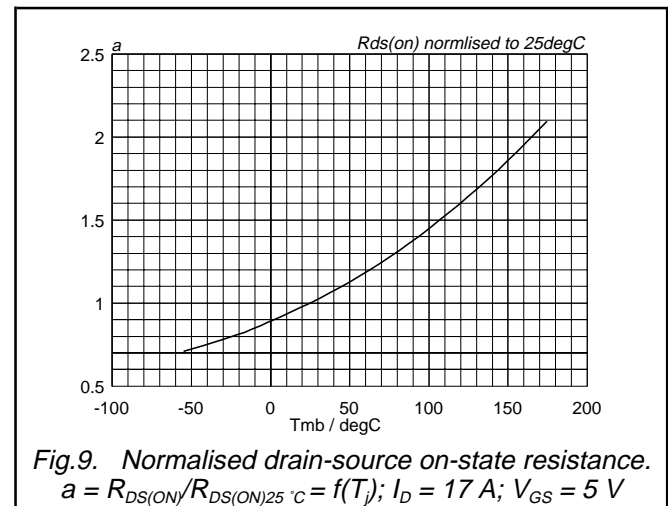
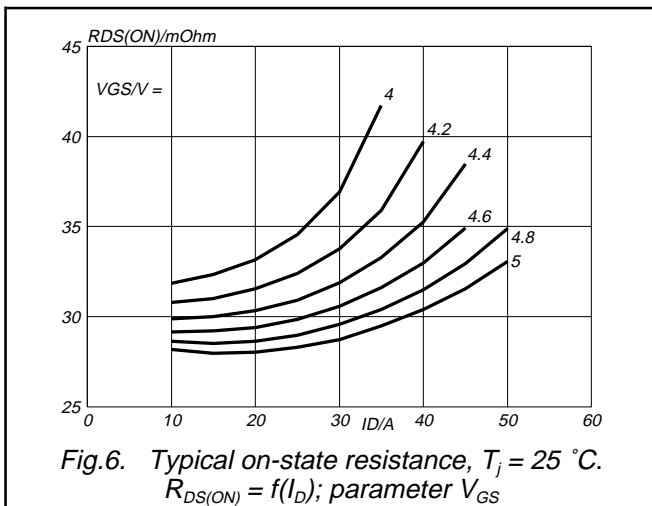
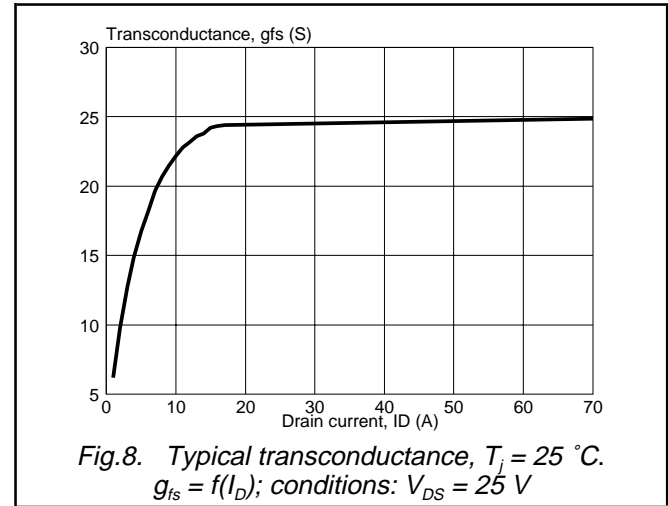
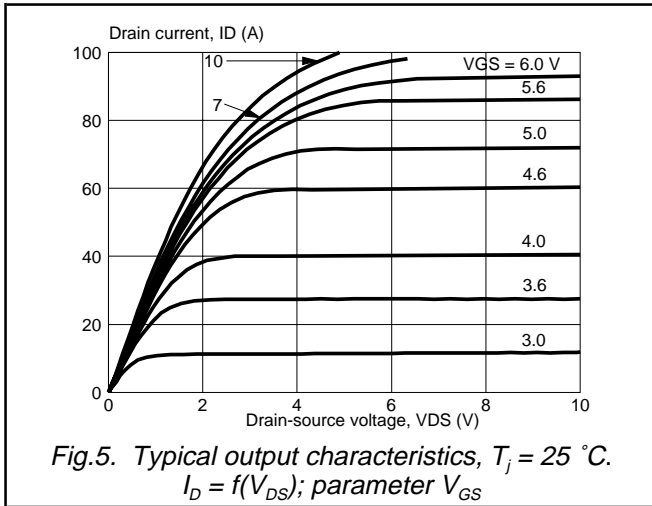

N-channel enhancement mode  
Logic level TrenchMOS™ transistor

IRLZ34N

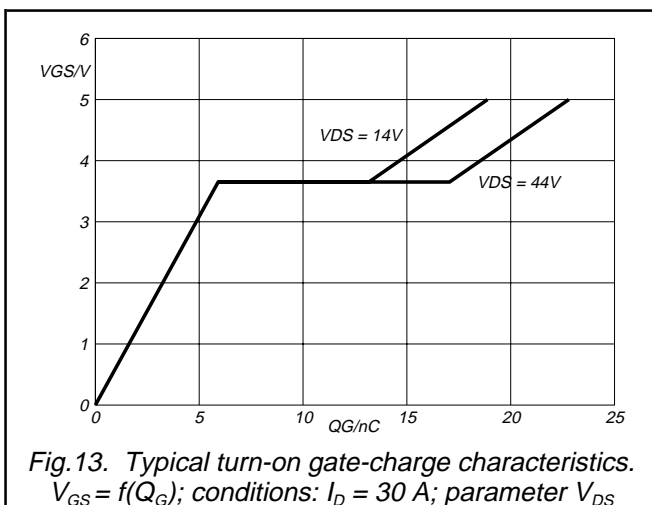
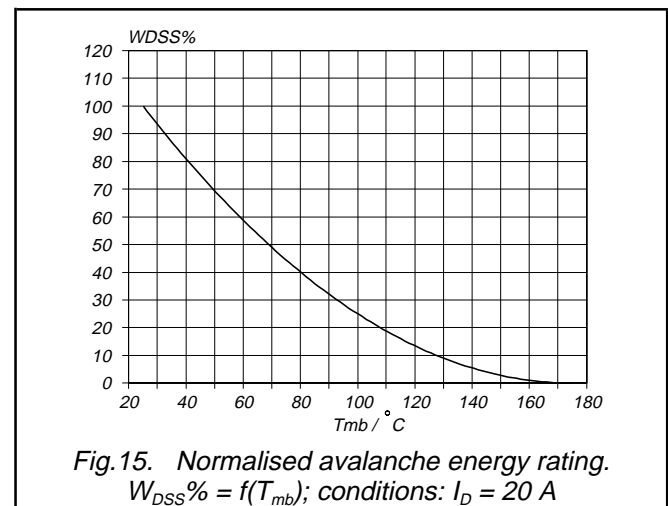
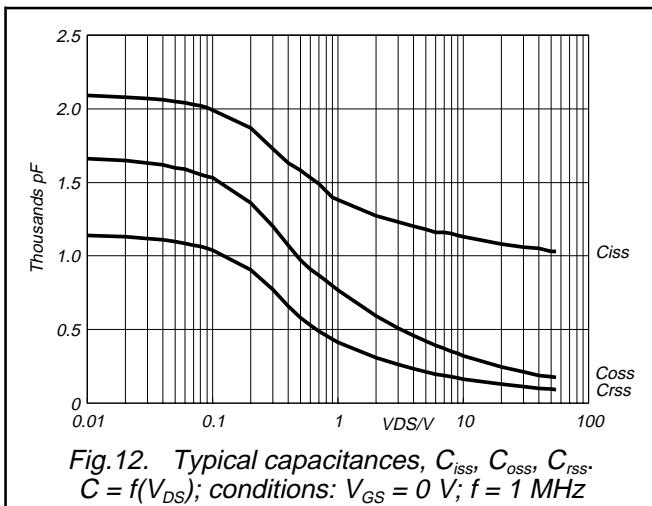
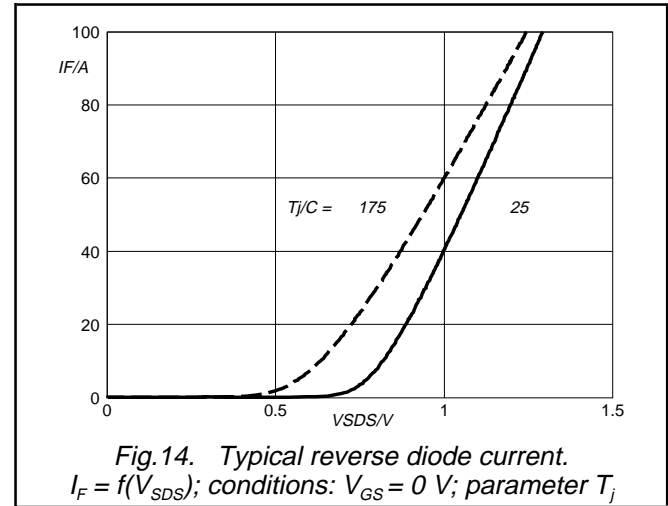
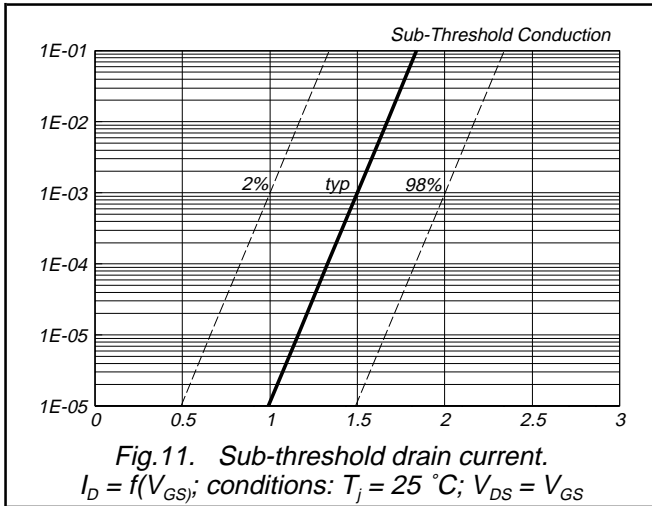

N-channel enhancement mode  
Logic level TrenchMOS™ transistor

IRLZ34N

MECHANICAL DATA

Plastic single-ended package; heatsink mounted; 1 mounting hole; 3-lead TO-220 SOT78

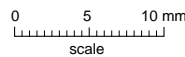
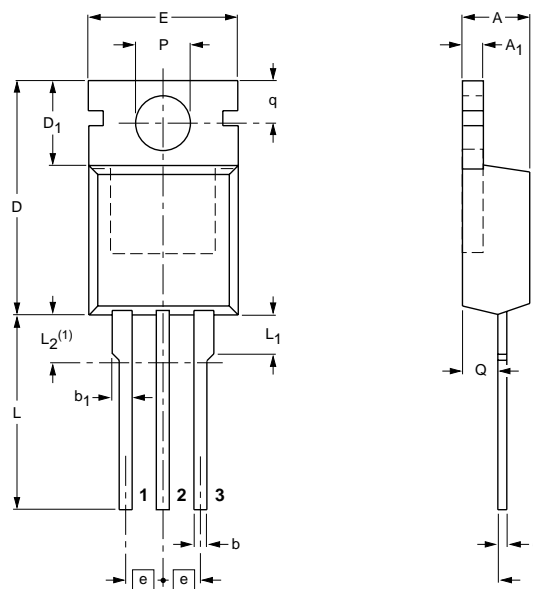

DIMENSIONS (mm are the original dimensions)

UNIT	A	A <sub>1</sub>	b	b <sub>1</sub>	c	D	D <sub>1</sub>	E	e	L	L <sub>1</sub>	L <sub>2</sub> <sup>(1)</sup> max.	P	q	Q
mm	4.5 4.1	1.39 1.27	0.9 0.7	1.3 1.0	0.7 0.4	15.8 15.2	6.4 5.9	10.3 9.7	2.54	15.0 13.5	3.30 2.79	3.0	3.8 3.6	3.0 2.7	2.6 2.2

Note

1. Terminals in this zone are not tinned.

OUTLINE VERSION	REFERENCES			EUROPEAN PROJECTION	ISSUE DATE
	IEC	JEDEC	EIAJ		
SOT78		TO-220			97-06-11

Fig. 17. SOT78 (TO220AB); pin 2 connected to mounting base (Net mass:2g)

Notes

1. This product is supplied in anti-static packaging. The gate-source input must be protected against static discharge during transport or handling.
2. Refer to mounting instructions for SOT78 (TO220AB) package.
3. Epoxy meets UL94 V0 at 1/8".

## N-channel enhancement mode Logic level TrenchMOS™ transistor

IRLZ34N

### DEFINITIONS

<b>Data sheet status</b>	
Objective specification	This data sheet contains target or goal specifications for product development.
Preliminary specification	This data sheet contains preliminary data; supplementary data may be published later.
Product specification	This data sheet contains final product specifications.
<b>Limiting values</b>	
Limiting values are given in accordance with the Absolute Maximum Rating System (IEC 134). Stress above one or more of the limiting values may cause permanent damage to the device. These are stress ratings only and operation of the device at these or at any other conditions above those given in the Characteristics sections of this specification is not implied. Exposure to limiting values for extended periods may affect device reliability.	
<b>Application information</b>	
Where application information is given, it is advisory and does not form part of the specification.	
<b>© Philips Electronics N.V. 1999</b>	
All rights are reserved. Reproduction in whole or in part is prohibited without the prior written consent of the copyright owner.	
The information presented in this document does not form part of any quotation or contract, it is believed to be accurate and reliable and may be changed without notice. No liability will be accepted by the publisher for any consequence of its use. Publication thereof does not convey nor imply any license under patent or other industrial or intellectual property rights.	

### LIFE SUPPORT APPLICATIONS

These products are not designed for use in life support appliances, devices or systems where malfunction of these products can be reasonably expected to result in personal injury. Philips customers using or selling these products for use in such applications do so at their own risk and agree to fully indemnify Philips for any damages resulting from such improper use or sale.