

**N-channel TrenchMOS™ transistor**

**PHB45NQ10T, PHP45NQ10T  
PHW45NQ10T**

**FEATURES**

- 'Trench' technology
- Very low on-state resistance
- Fast switching
- Low thermal resistance

**SYMBOL**

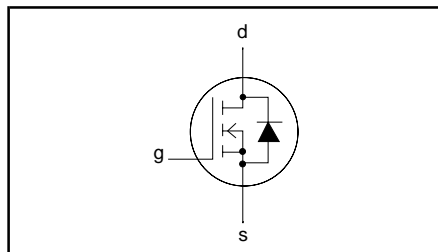

**QUICK REFERENCE DATA**

$V_{DSS} = 100\text{ V}$
$I_D = 47\text{ A}$
$R_{DS(ON)} \leq 25\text{ m}\Omega$

**GENERAL DESCRIPTION**

N-channel enhancement mode field-effect power transistor in a plastic envelope using 'trench' technology.

**Applications:-**

- d.c. to d.c. converters
- switched mode power supplies

The PHP45NQ10T is supplied in the SOT78 (TO220AB) conventional leaded package.  
The PHB45NQ10T is supplied in the SOT404 (D<sup>2</sup>PAK) surface mounting package.  
The PHW45NQ10T is supplied in the SOT429 (TO247) conventional leaded package.

**PINNING**

PIN	DESCRIPTION
1	gate
2	drain <sup>1</sup>
3	source
tab	drain

**SOT78 (TO220AB)**

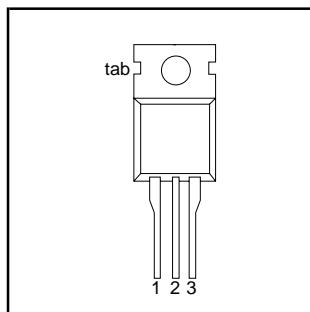

**SOT404 (D<sup>2</sup>PAK)**

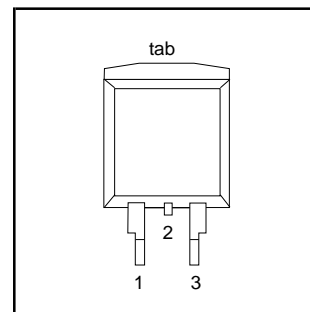

**SOT429 (TO247)**

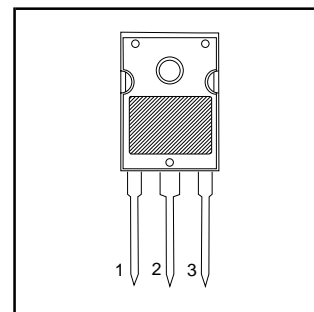

**LIMITING VALUES**

Limiting values in accordance with the Absolute Maximum System (IEC 134)

SYMBOL	PARAMETER	CONDITIONS	MIN.	MAX.	UNIT
$V_{DSS}$	Drain-source voltage	$T_j = 25\text{ }^\circ\text{C}$ to $175\text{ }^\circ\text{C}$	-	100	V
$V_{DGR}$	Drain-gate voltage	$T_j = 25\text{ }^\circ\text{C}$ to $175\text{ }^\circ\text{C}$ ; $R_{GS} = 20\text{ k}\Omega$	-	100	V
$V_{GS}$	Gate-source voltage		-	$\pm 20$	V
$I_D$	Continuous drain current	$T_{mb} = 25\text{ }^\circ\text{C}$ ; $V_{GS} = 10\text{ V}$	-	47	A
		$T_{mb} = 100\text{ }^\circ\text{C}$ ; $V_{GS} = 10\text{ V}$	-	33	A
$I_{DM}$	Pulsed drain current	$T_{mb} = 25\text{ }^\circ\text{C}$	-	188	A
$P_D$	Total power dissipation	$T_{mb} = 25\text{ }^\circ\text{C}$	-	150	W
$T_j, T_{stg}$	Operating junction and storage temperature		- 55	175	$^\circ\text{C}$

<sup>1</sup> It is not possible to make connection to pin 2 of the SOT404 package.

## N-channel TrenchMOS™ transistor

PHB45NQ10T, PHP45NQ10T  
PHW45NQ10T**AVALANCHE ENERGY LIMITING VALUES**

Limiting values in accordance with the Absolute Maximum System (IEC 134)

SYMBOL	PARAMETER	CONDITIONS	MIN.	MAX.	UNIT
$E_{AS}$	Non-repetitive avalanche energy	Unclamped inductive load, $I_{AS} = 40$ A; $t_p = 100$ $\mu$ s; $T_j$ prior to avalanche = 25 °C; $V_{DD} \leq 25$ V; $R_{GS} = 50$ $\Omega$ ; $V_{GS} = 10$ V; refer to fig:15	-	260	mJ
$I_{AS}$	Non-repetitive avalanche current		-	47	A

**THERMAL RESISTANCES**

SYMBOL	PARAMETER	CONDITIONS	MIN.	TYP.	MAX.	UNIT
$R_{th\ j-mb}$	Thermal resistance junction to mounting base		-	-	1	K/W
$R_{th\ j-a}$	Thermal resistance junction to ambient	SOT78 package, in free air	-	60	-	K/W
		SOT429 package, in free air	-	45	-	K/W
		SOT404 package, pcb mounted, minimum footprint	-	50	-	K/W

**ELECTRICAL CHARACTERISTICS** $T_j = 25$  °C unless otherwise specified

SYMBOL	PARAMETER	CONDITIONS	MIN.	TYP.	MAX.	UNIT
$V_{(BR)DSS}$	Drain-source breakdown voltage	$V_{GS} = 0$ V; $I_D = 0.25$ mA; $T_j = -55$ °C	100 89	-	-	V V
$V_{GS(TO)}$	Gate threshold voltage	$V_{DS} = V_{GS}$ ; $I_D = 1$ mA	2	3	4	V
		$T_j = 175$ °C	1	-	-	V
		$T_j = -55$ °C	-	-	6	V
$R_{DS(ON)}$	Drain-source on-state resistance	$V_{GS} = 10$ V; $I_D = 25$ A	-	22	25	m $\Omega$
		$T_j = 175$ °C	-	-	68	m $\Omega$
$I_{GSS}$	Gate source leakage current	$V_{GS} = \pm 10$ V; $V_{DS} = 0$ V	-	0.02	100	nA
$I_{DSS}$	Zero gate voltage drain current	$V_{DS} = 100$ V; $V_{GS} = 0$ V; $T_j = 175$ °C	-	0.05	10	$\mu$ A
			-	-	500	$\mu$ A
$Q_{g(tot)}$	Total gate charge	$I_D = 45$ A; $V_{DD} = 80$ V; $V_{GS} = 10$ V	-	61	-	nC
$Q_{gs}$	Gate-source charge		-	13	-	nC
$Q_{gd}$	Gate-drain (Miller) charge		-	25	-	nC
$t_{don}$	Turn-on delay time	$V_{DD} = 50$ V; $R_D = 1.8$ $\Omega$ ; $V_{GS} = 10$ V; $R_G = 5.6$ $\Omega$ Resistive load	-	18	-	ns
$t_r$	Turn-on rise time		-	72	-	ns
$t_{doff}$	Turn-off delay time		-	69	-	ns
$t_f$	Turn-off fall time		-	58	-	ns
$L_d$	Internal drain inductance	Measured tab to centre of die	-	3.5	-	nH
$L_d$	Internal drain inductance	Measured from drain lead to centre of die (SOT78 and SOT429 packages)	-	4.5	-	nH
$L_s$	Internal source inductance	Measured from source lead to source bond pad	-	7.5	-	nH
$C_{iss}$	Input capacitance	$V_{GS} = 0$ V; $V_{DS} = 25$ V; $f = 1$ MHz	-	2600	-	pF
$C_{oss}$	Output capacitance		-	340	-	pF
$C_{riss}$	Feedback capacitance		-	195	-	pF

## N-channel TrenchMOS™ transistor

PHB45NQ10T, PHP45NQ10T  
PHW45NQ10T**REVERSE DIODE LIMITING VALUES AND CHARACTERISTICS** $T_j = 25^\circ\text{C}$  unless otherwise specified

SYMBOL	PARAMETER	CONDITIONS	MIN.	TYP.	MAX.	UNIT
$I_S$	Continuous source current (body diode)		-	-	47	A
$I_{SM}$	Pulsed source current (body diode)		-	-	188	A
$V_{SD}$	Diode forward voltage	$I_F = 25\text{ A}; V_{GS} = 0\text{ V}$	-	0.87	1.2	V
$t_{rr}$	Reverse recovery time	$I_F = 20\text{ A}; -di_F/dt = 100\text{ A}/\mu\text{s};$ $V_{GS} = 0\text{ V}; V_R = 25\text{ V}$	-	82	-	ns
$Q_{rr}$	Reverse recovery charge		-	0.26	-	$\mu\text{C}$

N-channel TrenchMOS™ transistor

PHB45NQ10T, PHP45NQ10T  
PHW45NQ10T

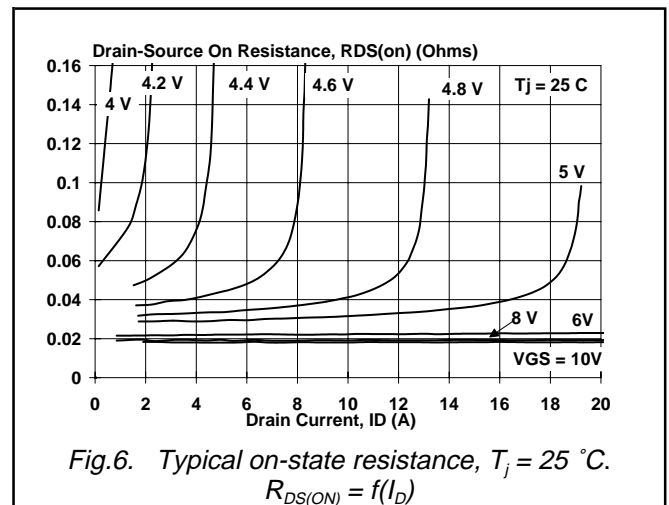
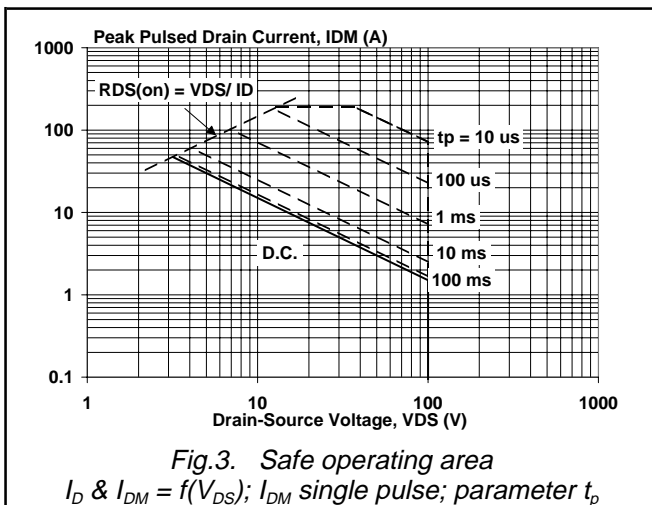
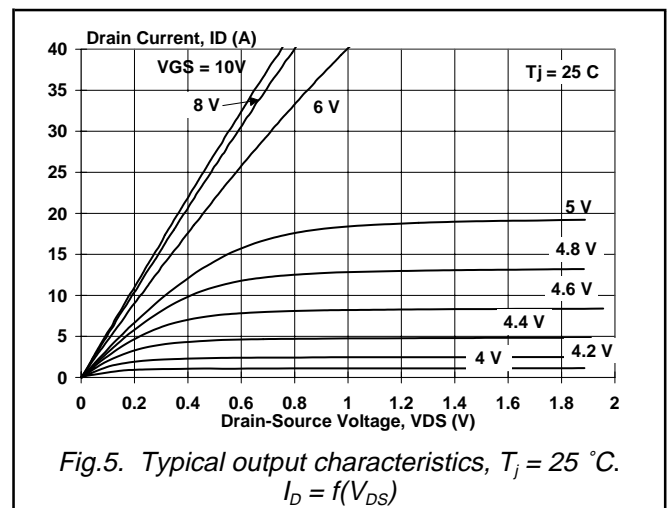
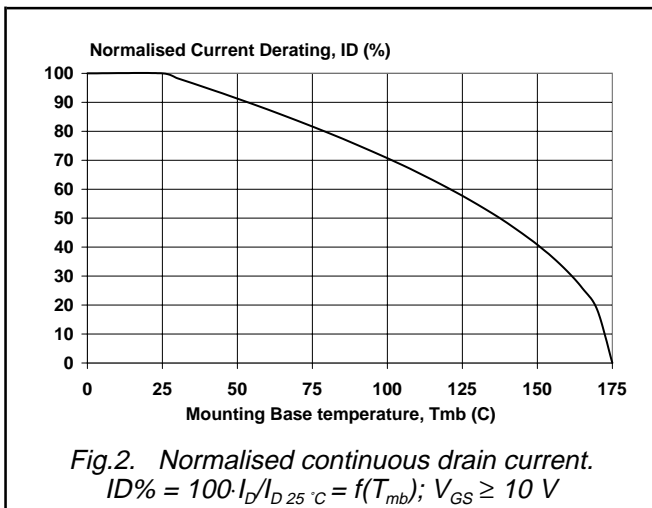
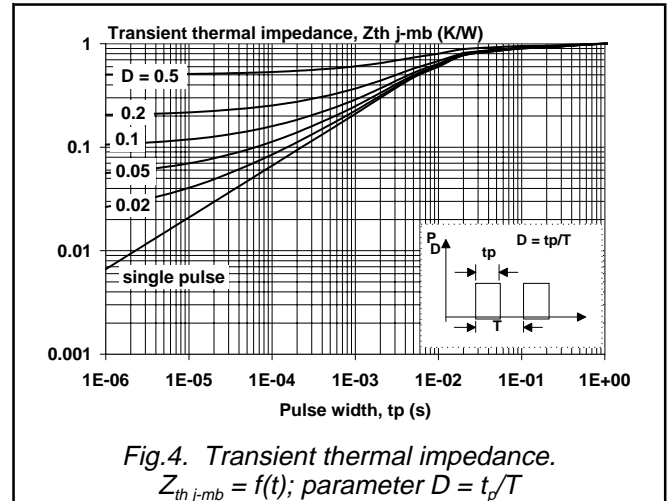

N-channel TrenchMOS™ transistor

PHB45NQ10T, PHP45NQ10T  
PHW45NQ10T

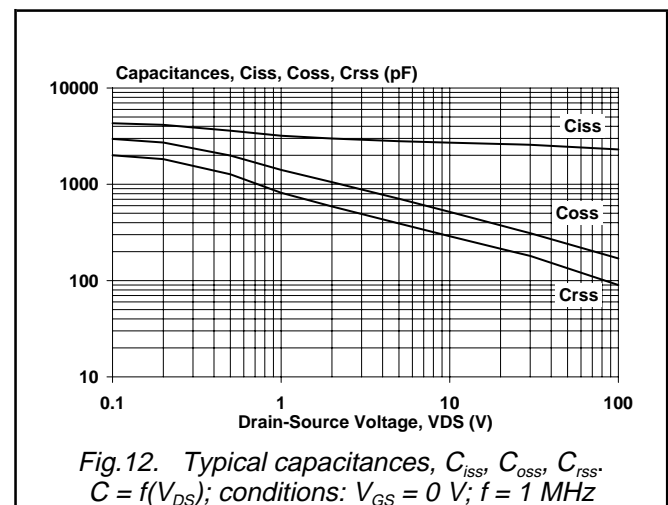
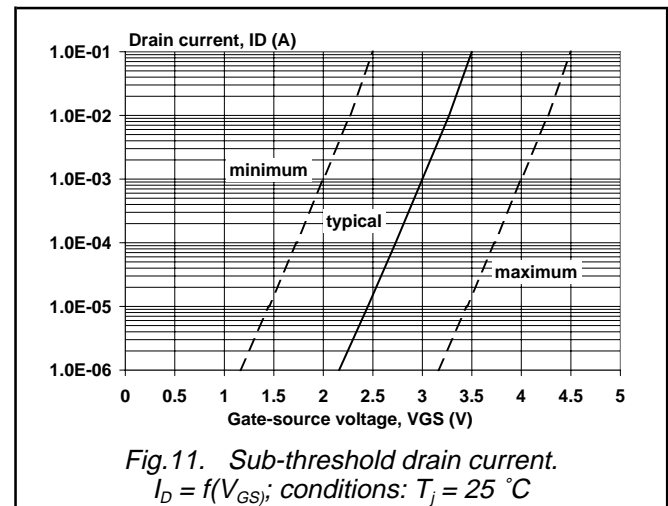
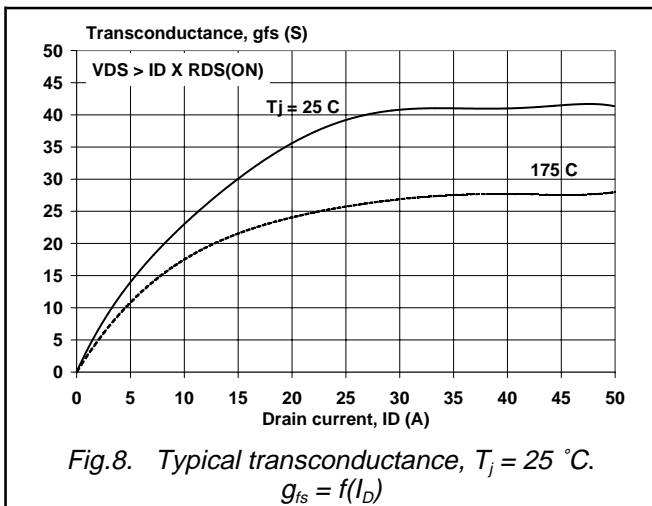
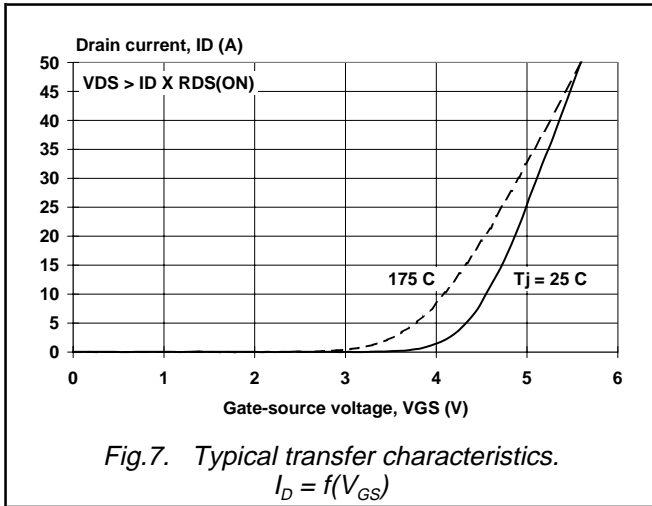

N-channel TrenchMOS™ transistor

PHB45NQ10T, PHP45NQ10T  
PHW45NQ10T

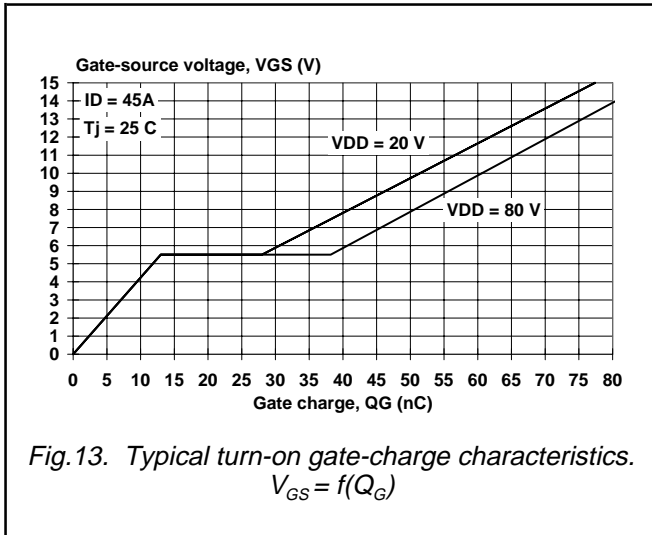

Fig.13. Typical turn-on gate-charge characteristics.  
 $V_{GS} = f(Q_G)$

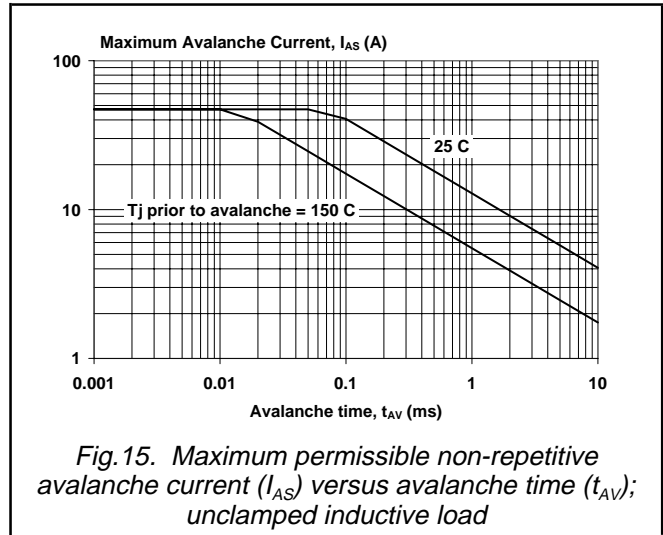

Fig.15. Maximum permissible non-repetitive avalanche current ( $I_{AS}$ ) versus avalanche time ( $t_{AV}$ ); unclamped inductive load

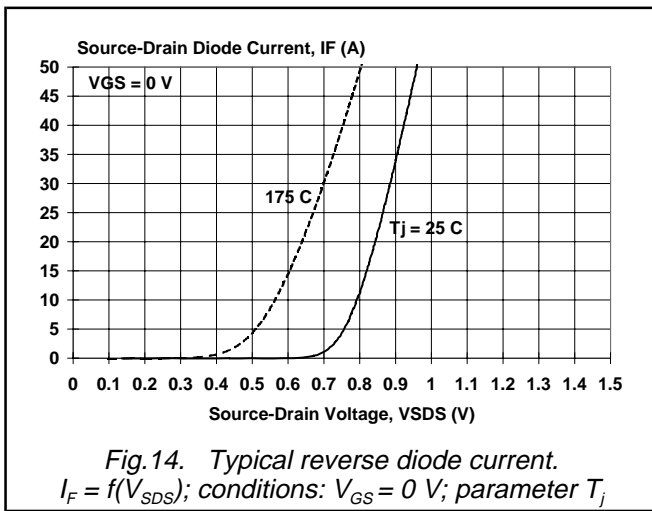

Fig.14. Typical reverse diode current.  
 $I_F = f(V_{SDS})$ ; conditions:  $V_{GS} = 0 V$ ; parameter  $T_j$

N-channel TrenchMOS™ transistor

PHB45NQ10T, PHP45NQ10T  
PHW45NQ10T

MECHANICAL DATA

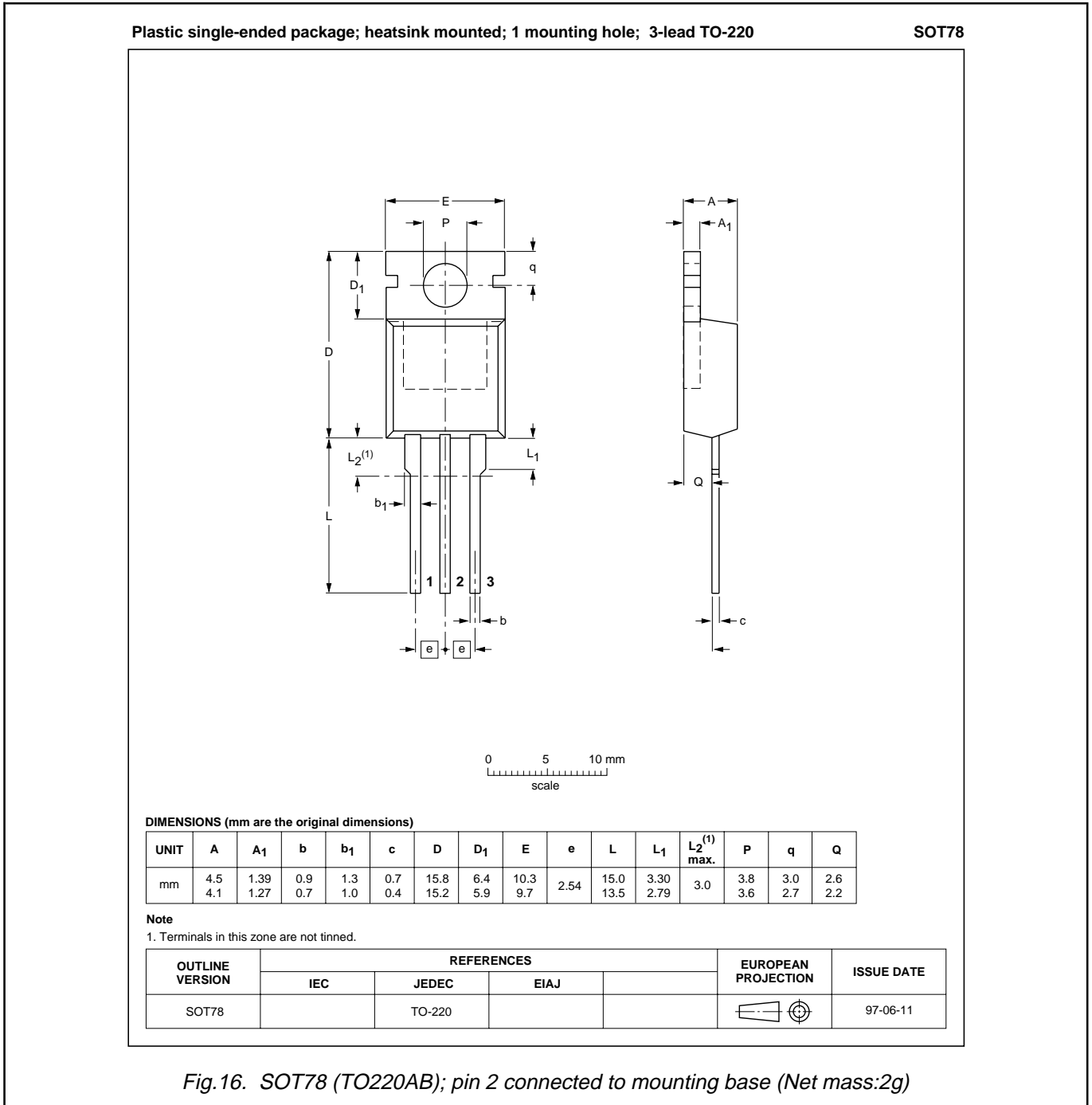

Fig. 16. SOT78 (TO220AB); pin 2 connected to mounting base (Net mass:2g)

Notes

1. This product is supplied in anti-static packaging. The gate-source input must be protected against static discharge during transport or handling.
2. Refer to mounting instructions for SOT78 (TO220AB) package.
3. Epoxy meets UL94 V0 at 1/8".

N-channel TrenchMOS™ transistor

PHB45NQ10T, PHP45NQ10T  
PHW45NQ10T

MECHANICAL DATA



**Notes**

1. This product is supplied in anti-static packaging. The gate-source input must be protected against static discharge during transport or handling.
2. Refer to SMD Footprint Design and Soldering Guidelines, Data Handbook SC18.
3. Epoxy meets UL94 V0 at 1/8".



N-channel TrenchMOS™ transistor

PHB45NQ10T, PHP45NQ10T  
PHW45NQ10T

**MOUNTING INSTRUCTIONS**

*Dimensions in mm*



*Fig.18. SOT404 : soldering pattern for surface mounting.*

N-channel TrenchMOS™ transistor

PHB45NQ10T, PHP45NQ10T  
PHW45NQ10T

MECHANICAL DATA

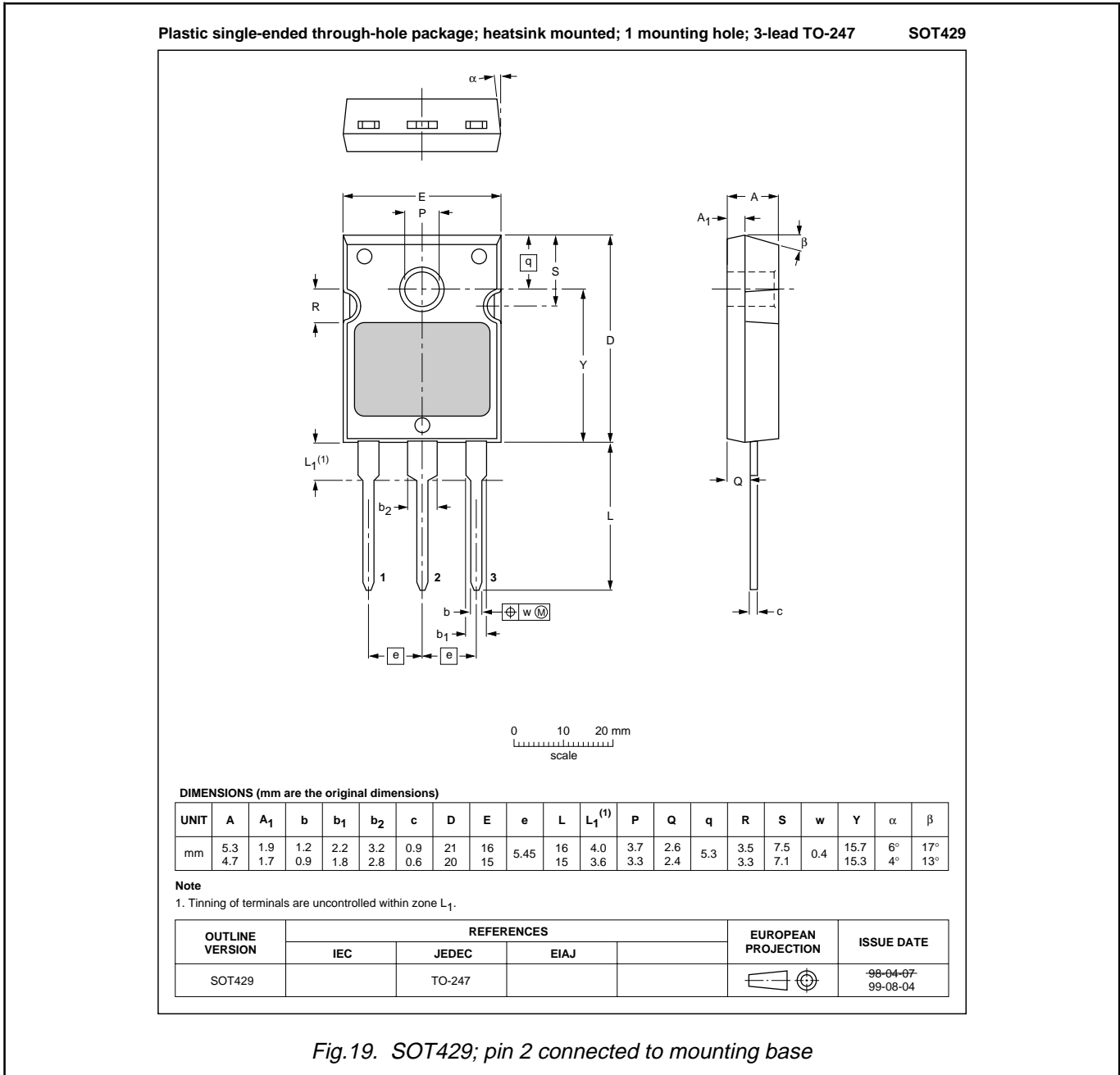

Fig. 19. SOT429; pin 2 connected to mounting base

Notes

1. Observe the general handling precautions for electrostatic-discharge sensitive devices (ESDs) to prevent damage to MOS gate oxide.
2. Refer to mounting instructions for SOT429 envelope.
3. Epoxy meets UL94 V0 at 1/8".

N-channel TrenchMOS™ transistor

PHB45NQ10T, PHP45NQ10T  
PHW45NQ10T**DEFINITIONS**

<b>Data sheet status</b>	
Objective specification	This data sheet contains target or goal specifications for product development.
Preliminary specification	This data sheet contains preliminary data; supplementary data may be published later.
Product specification	This data sheet contains final product specifications.
<b>Limiting values</b>	
Limiting values are given in accordance with the Absolute Maximum Rating System (IEC 134). Stress above one or more of the limiting values may cause permanent damage to the device. These are stress ratings only and operation of the device at these or at any other conditions above those given in the Characteristics sections of this specification is not implied. Exposure to limiting values for extended periods may affect device reliability.	
<b>Application information</b>	
Where application information is given, it is advisory and does not form part of the specification.	
<b>© Philips Electronics N.V. 1999</b>	
All rights are reserved. Reproduction in whole or in part is prohibited without the prior written consent of the copyright owner.	
The information presented in this document does not form part of any quotation or contract, it is believed to be accurate and reliable and may be changed without notice. No liability will be accepted by the publisher for any consequence of its use. Publication thereof does not convey nor imply any license under patent or other industrial or intellectual property rights.	

**LIFE SUPPORT APPLICATIONS**

These products are not designed for use in life support appliances, devices or systems where malfunction of these products can be reasonably expected to result in personal injury. Philips customers using or selling these products for use in such applications do so at their own risk and agree to fully indemnify Philips for any damages resulting from such improper use or sale.