

### FEATURES:

- RAD-PAK® technology-hardened against natural space radiation
- Total dose hardness:
  - > 100 krad (Si), depending upon space mission
- Package:
  - 16 pin Rad-Pak® flat package
- Low input offset voltage 150µV max
- Low offset voltage drift
  - +1.2µV/°C max (over -55 to +125°C)
- Low supply current (per amplifier) 725 µA max
- High open-loop gain 5000V/mV min
- Input bias current 3 nA Max
- Low noise voltage density 11 nV per (Hz)<sup>1/2</sup> at 1 kHz
- Stable with large capacitive loads 10 nF typ

### DESCRIPTION:

Maxwell Technologies' OP400 monolithic quad operational amplifier microcircuit features a greater than 100 krad (Si) typical total dose tolerance, depending upon space mission. Using Maxwell's radiation-hardened RAD-PAK® packaging technology, the OP400 has an extremely low input offset voltage no less than 150 mV with a drift of under 1.2 mV/°C, guaranteed over the full military temperature range. The OP400 features low power consumption, drawing less than 725 µA per amplifier.

Maxwell Technologies' patented RAD-PAK packaging technology incorporates radiation shielding in the microcircuit package. It eliminates the need for box shielding while providing the required radiation shielding for a lifetime in orbit or space mission. In a GEO orbit, RAD-PAK provides greater than 100 krad (Si) radiation dose tolerance. This product is available with screening up to Class S.

TABLE 1. PINOUT DESCRIPTION

PIN	SYMBOL	DESCRIPTION
1, 7, 10, 16	OUT A - D	Output Signal
2, 6, 11, 15	-IN A - D	Negative Input Signal
3, 5, 12, 14	+IN A - D	Positive Input Signal
8, 9	NC	Not Connected
4	V+	Positive Voltage
13	V-	Negative Voltage

TABLE 2. OP400 ABSOLUTE MAXIMUM RATINGS

PARAMETER	SYMBOL	MIN	MAX	UNIT
Supply Voltage	$V_{CC}$		$\pm 20$	V
Differential Input Voltage			$\pm 30$	V
Input Voltage				Supply Voltage
Output Short-Circuit Duration				Continuous
Storage Temperature Range	$T_S$	-65	150	$^{\circ}\text{C}$
Operating Temperature Range	$T_A$	-55	125	$^{\circ}\text{C}$

TABLE 3. DELTA LIMITS

PARAMETER	VARIATION
ICC	$\pm 10\%$ of specified value in Table 4

TABLE 4. OP400 DC ELECTRICAL CHARACTERISTICS

( $V_S = \pm 15\text{V}$ ,  $T_A = -55$  TO  $125^{\circ}\text{C}$ , UNLESS OTHERWISE SPECIFIED)

PARAMETER	SYMBOL	TEST CONDITIONS	MIN	TYP	MAX	UNITS	
Input Offset Voltage	$V_{OS}$		+25 $^{\circ}\text{C}$	---	40	150	$\mu\text{V}$
			-55 to 125 $^{\circ}\text{C}$	--	70	270	
Long Term Input Voltage Stability	---		---	0.1	---	$\mu\text{V}/\text{mo}$	
Input Offset Current	$I_{OS}$	$V_{CM} = 0\text{V}$	+25 $^{\circ}\text{C}$	---	0.1	1.0	nA
			-55 to 125 $^{\circ}\text{C}$		0.1	2.5	
Input Bias Current	$I_B$	$V_{CM} = 0\text{V}$	+25 $^{\circ}\text{C}$	---	0.75	3.0	nA
			-55 to 125 $^{\circ}\text{C}$		1.30	5.0	

TABLE 4. OP400 DC ELECTRICAL CHARACTERISTICS

( $V_S = \pm 15V$ ,  $T_A = -55$  TO  $125^\circ C$ , UNLESS OTHERWISE SPECIFIED)

PARAMETER	SYMBOL	TEST CONDITIONS		MIN	TYP	MAX	UNITS
Input Resistance Differential Mode	$R_{IN}$	+25°C		---	10	---	MΩ
Input Resistance Common Mode	$R_{INCM}$			---	200	---	GΩ
Large Signal Voltage Gain	$A_{VO}$	$V_O = \pm 10V$ $R_L = 10\text{ k}\Omega^1$	+25°C	5000	12000	---	V/mV
			-55 to 125°C	3000	9000	--	
		$R_L = 2\text{ k}\Omega$	+25°C	2000	3500	---	
			-55 to 125°C	1000	2300	--	
Input Voltage Range <sup>2</sup>	IVR	3/	+25°C	±12	±13	---	V
			-55 to 125°C	±12	±12.5	--	
Common Mode Rejection	CMR	$V_{CM} = \pm 12V$	+25°C	120	140	---	dB
			-55 to 125°C	115	130	--	
Power Supply Rejection Ratio	PSRR	$V_S = \pm 3V$ to $\pm 18V$	+25°C	---	0.1	1.8	μV/V
			-55 to 125°C	--	0.2	3.2	
Output Voltage Swing	$V_O$	$R_L = 10\text{ k}\Omega$		±12	±12.6	---	V
		$R_L = 2\text{ k}\Omega$		±11	±12.4	---	
Supply Current Per Amplifier	$I_{SV}$	No Load	+25°C	---	600	725	μA
			-55 to 125°C	--	600	775	
Input Capacitance	$C_{IN}$		+25°C	---	3.2	---	pF
Capacitive Load Stability		$A_V = +1$ No Oscillations	+25°C	---	10	---	nF

1. Guaranteed but not 100% Tested

2. Guaranteed by CMR test.

TABLE 5. OP400 AC Electrical Characteristics

( $V_S = \pm 15V$ ,  $T_A = -55$  TO  $125^\circ C$ , UNLESS OTHERWISE SPECIFIED.)

PARAMETER	SYMBOL	Test Conditions		MIN	TYP	MAX	UNIT
Input Noise Voltage	$e_{n,p-p}$	0.1 Hz to 10 Hz	+25°C	---	0.5	---	μV <sub>P-P</sub>
Input Noise Voltage Density	$e_n$	$f_o = 10\text{ Hz}$	+25°C	---	22	--	nV√Hz
		$f_o = 1\text{ KHz}$	+25°C	---	11	--	
Input Noise Current	$i_{n,p-p}$	0.1 Hz to 10 Hz	+25°C	---	15	---	pA <sub>P-P</sub>
Input Noise Current Density	$i_n$	$f_o = 10\text{ Hz}$	+25°C	---	0.6	---	nV√Hz
Slew Rate	SR			0.1	0.15	---	V/μs
Gain Bandwidth Product	GBWP	$A_V = +1$		---	500	---	kHz
Channel Separation	CS	$V_O = 20\text{ V}_{p-p}$ $f_o = 10\text{ Hz}^1$	+25°C	123	135	---	dB

1. Guaranteed but not 100% tested.

## OP400 TYPICAL OPERATING CHARACTERISTICS

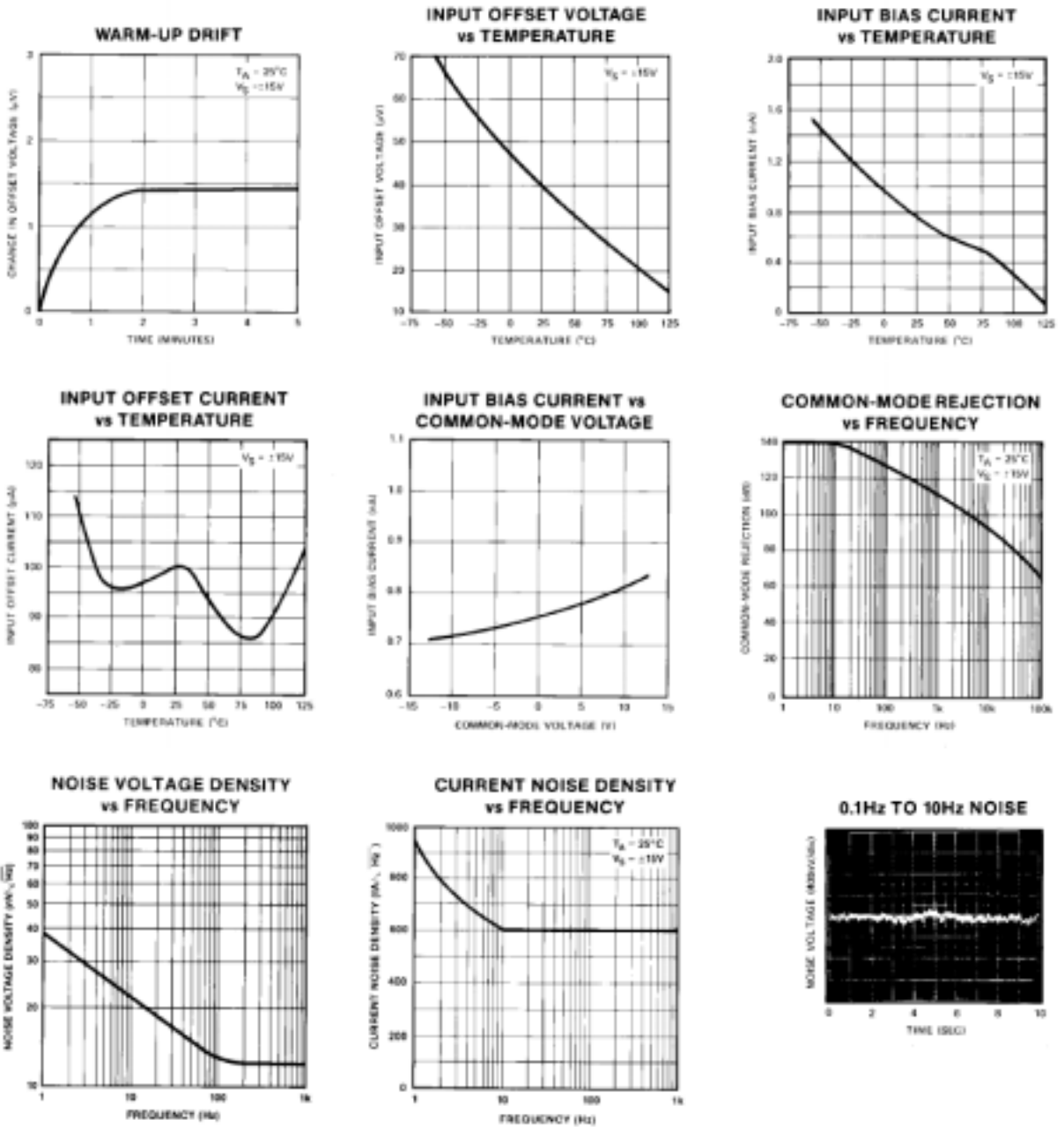

## OP400 TYPICAL OPERATING CHARACTERISTICS (CONTINUED)

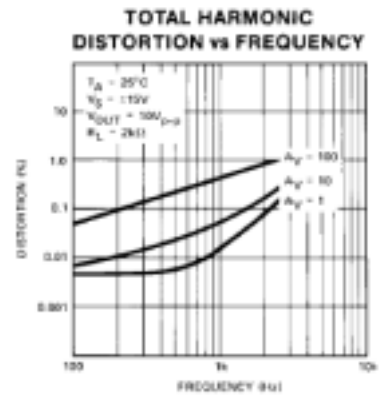
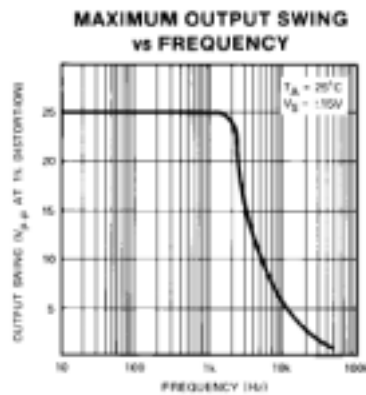
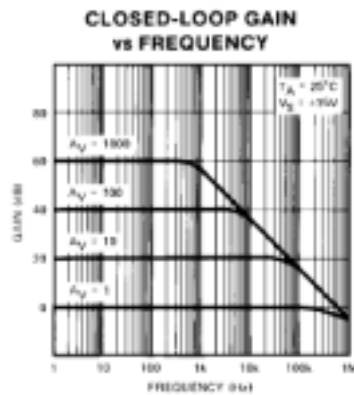
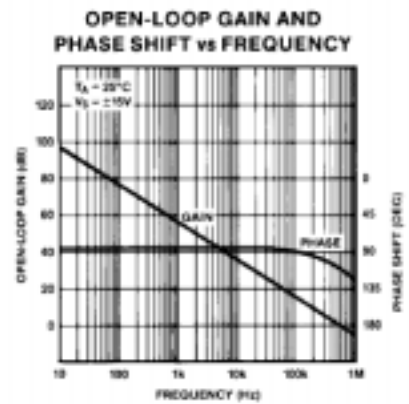
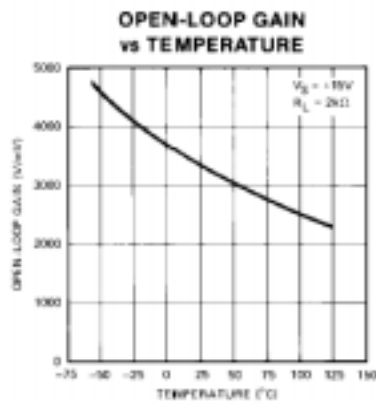
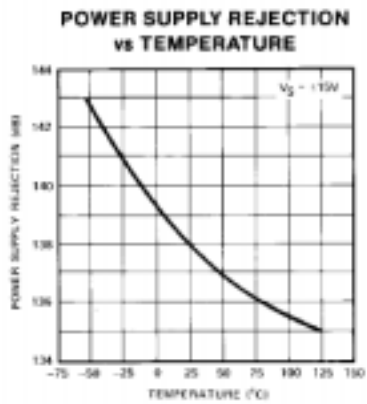
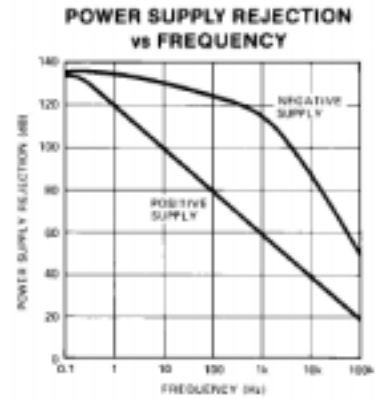
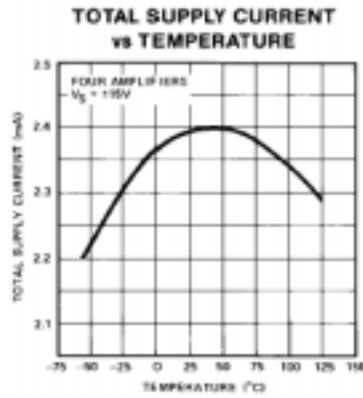
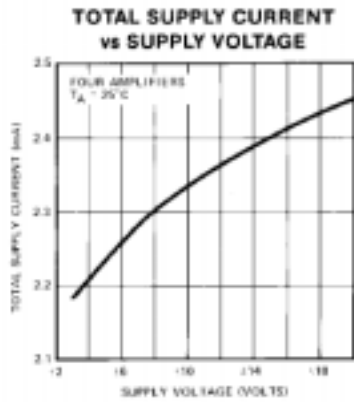

## OP400 TYPICAL OPERATING CHARACTERISTICS (CONTINUED)

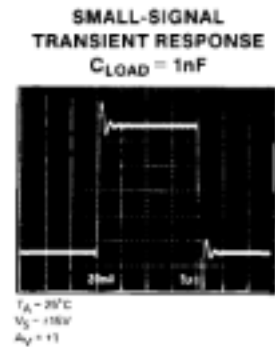
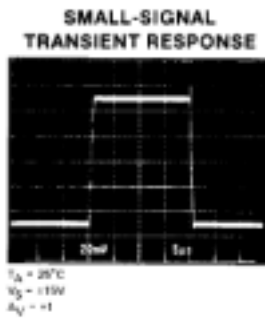
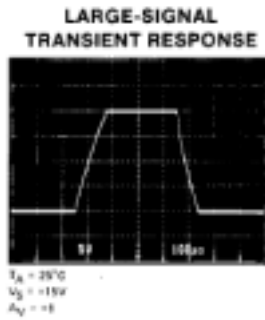
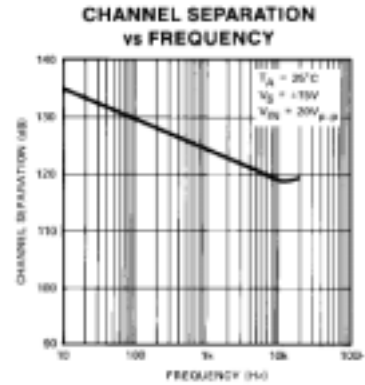
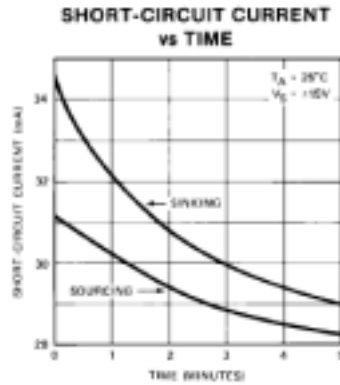
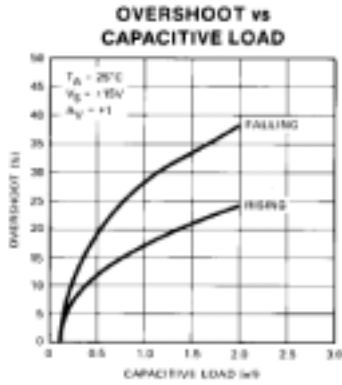

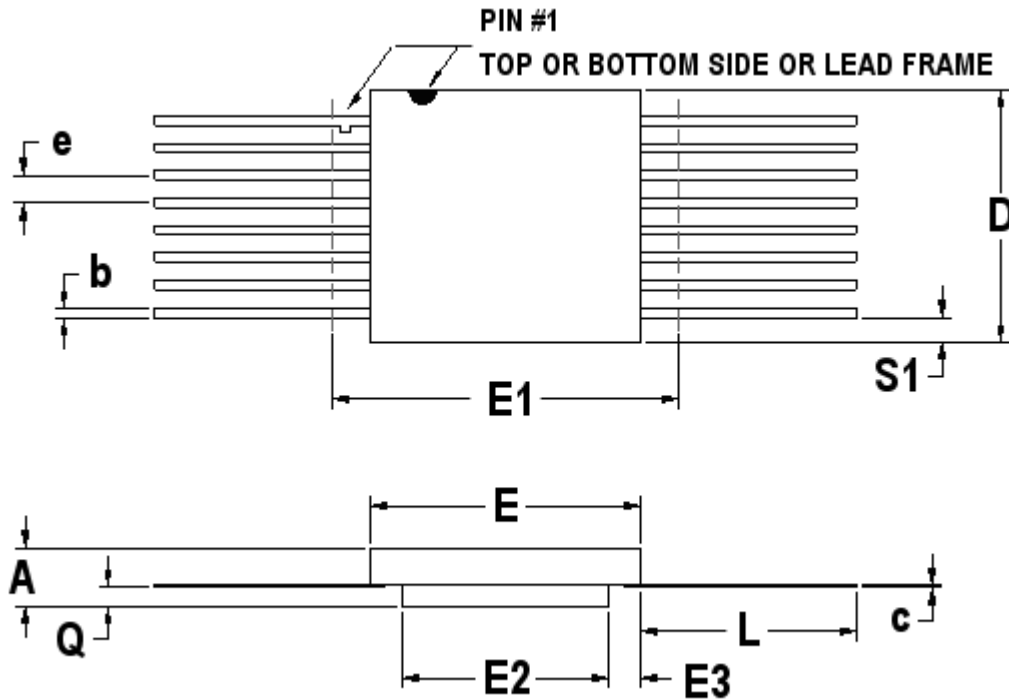

16-PIN RAK-PAK® FLAT PACKAGE

SYMBOL	DIMENSION		
	MIN	NOM	MAX
A	0.115	0.135	0.150
b	0.015	0.017	0.022
c	0.004	0.005	0.009
D	--	0.415	0.440
E	0.245	0.280	0.285
E1	--	--	0.315
E2	0.120	0.156	--
E3	0.030	0.062	--
e	0.050 BSC		
L	0.325	0.335	0.345
Q	0.020	0.033	0.045
S1	0.005	0.024	--
N	16		

F16-01

Note: All dimensions in inches.

## Important Notice:

These data sheets are created using the chip manufacturer's published specifications. Maxwell Technologies verifies functionality by testing key parameters either by 100% testing, sample testing or characterization.

The specifications presented within these data sheets represent the latest and most accurate information available to date. However, these specifications are subject to change without notice and Maxwell Technologies assumes no responsibility for the use of this information.

Maxwell Technologies' products are not authorized for use as critical components in life support devices or systems without express written approval from Maxwell Technologies.

Any claim against Maxwell Technologies must be made within 90 days from the date of shipment from Maxwell Technologies. Maxwell Technologies' liability shall be limited to replacement of defective parts.



## Product Ordering Options

