

## GL5□□40 series

### ø5mm(T-1 3/4), Cylinder Type, Colored Transparency LED Lamps for Indicator

#### ■ Outline Dimensions

(Unit : mm)

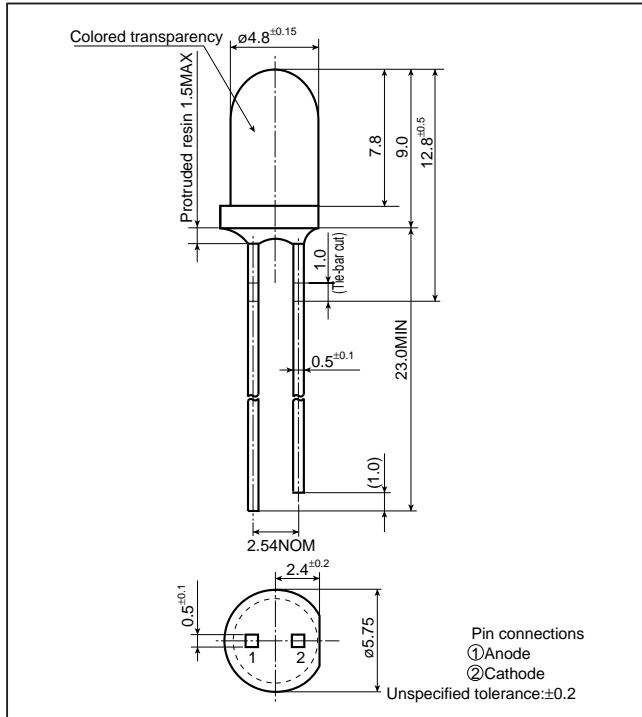

#### ■ Radiation Diagram

(Ta=25°C)

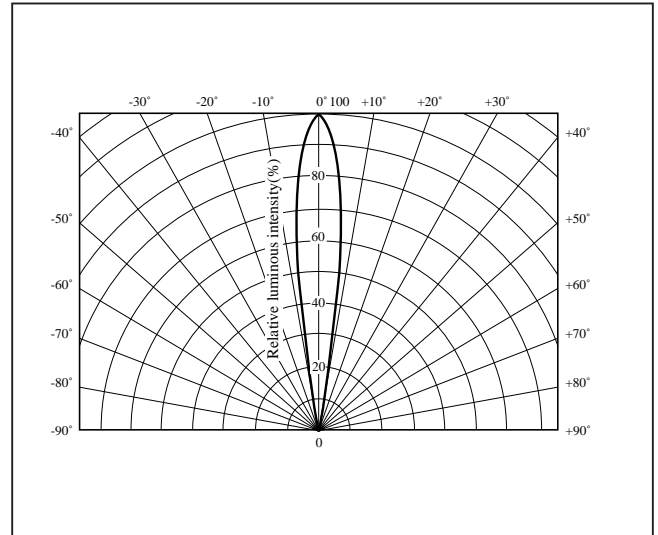

#### ■ Absolute Maximum Ratings

(Ta=25°C)

Model No.	Radiation color	Radiation material	Power dissipation P (mW)	Forward current I <sub>F</sub> (mA)	Peak forward current I <sub>FM</sub> *1 (mA)	Derating factor (mA/°C)		Reverse voltage V <sub>R</sub> (V)	Operating temperature T <sub>opr</sub> (°C)	Storage temperature T <sub>stg</sub> (°C)	Soldering temperature T <sub>sol</sub> *2 (°C)
						DC	Pulse				
GL5PR40	Red	GaP	23	10	50	0.13	0.67	5	-25 to +85	-25 to +100	260
GL5HD40	Red	GaAsP on GaP	84	30	50	0.40	0.67	5	-25 to +85	-25 to +100	260
GL5HS40	Sunset orange	GaAsP on GaP	84	30	50	0.40	0.67	5	-25 to +85	-25 to +100	260
GL5HY40	Yellow	GaAsP on GaP	84	30	50	0.40	0.67	5	-25 to +85	-25 to +100	260
GL5EG40	Yellow-green	GaP	84	30	50	0.40	0.67	5	-25 to +85	-25 to +100	260
GL5KG40	Green	GaP	84	30	50	0.40	0.67	5	-25 to +85	-25 to +100	260

\*1 Duty ratio=1/10, Pulse width=0.1ms

\*2 5s or less(At the position of 1.6mm or more from the bottom face of resin package)

#### ■ Electro-optical Characteristics

(Ta=25°C)

Lens type	Model No.	Forward voltage V <sub>F</sub> (V)		Peak emission wavelength		Luminous intensity		Spectrum radiation bandwidth		Reverse current		Terminal capacitance		Page for characteristics diagrams
		TYP	MAX	λ <sub>p</sub> (nm) TYP	I <sub>F</sub> (mA)	I <sub>v</sub> (mcd) TYP	I <sub>F</sub> (mA)	Δλ(nm) TYP	I <sub>F</sub> (mA)	I <sub>R</sub> (μA) MAX	V <sub>R</sub> (V)	C <sub>t</sub> (pF) TYP	(MHz)	
Colored transparency	GL5PR40	1.9	2.3	695	5	35	5	100	5	10	4	55	1	→
	GL5HD40	2.0	2.8	635	20	250	20	35	20	10	4	20	1	→
	GL5HS40	2.0	2.8	610	20	200	20	35	20	10	4	15	1	→
	GL5HY40	2.0	2.8	585	20	250	20	30	20	10	4	35	1	→
	GL5EG40	2.1	2.8	565	20	250	20	30	20	10	4	35	1	→
	GL5KG40	2.1	2.8	555	20	70	20	25	20	10	4	40	1	→

(Notice) • In the absence of confirmation by device specification sheets, SHARP takes no responsibility for any defects that may occur in equipment using any SHARP devices shown in catalogs, data books, etc. Contact SHARP in order to obtain the latest device specification sheets before using any SHARP device.

(Internet) • Data for sharp's optoelectronic/power device is provided for internet.(Address <http://www.sharp.co.jp/ecg/>)

# LED Lamp Characteristics Diagrams

## PR series

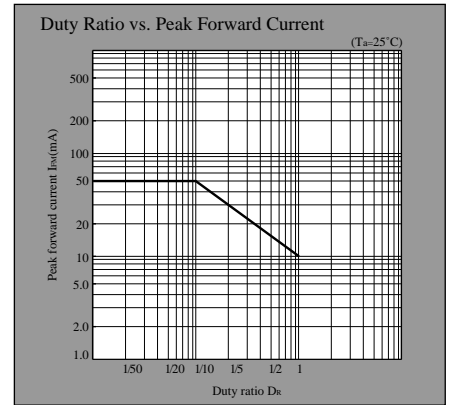
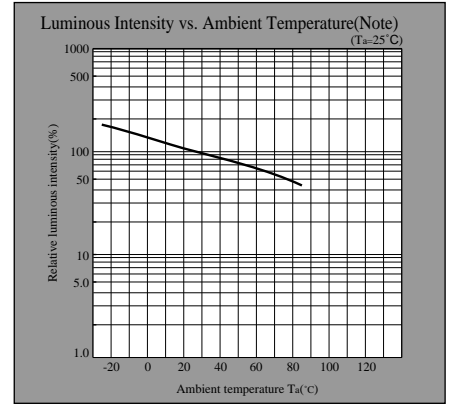

## HD series

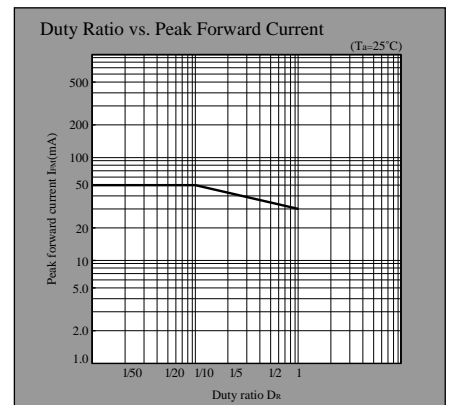
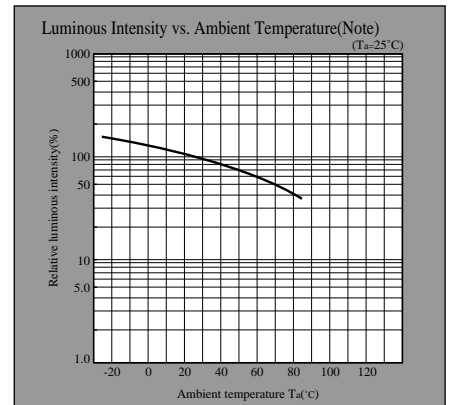

Note) Characteristics shown in diagrams are typical values. (not assurance value)

- (Notice) • In the absence of confirmation by device specification sheets, SHARP takes no responsibility for any defects that may occur in equipment using any SHARP devices shown in catalogs, data books, etc. Contact SHARP in order to obtain the latest device specification sheets before using any SHARP device.
- (Internet) • Data for sharp's optoelectronic/power device is provided for internet.(Address <http://www.sharp.co.jp/ecg/>)

# LED Lamp Characteristics Diagrams

## HS series

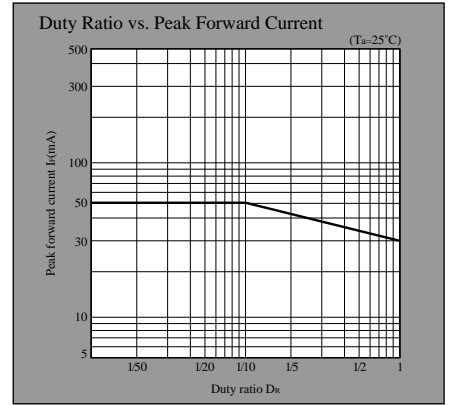
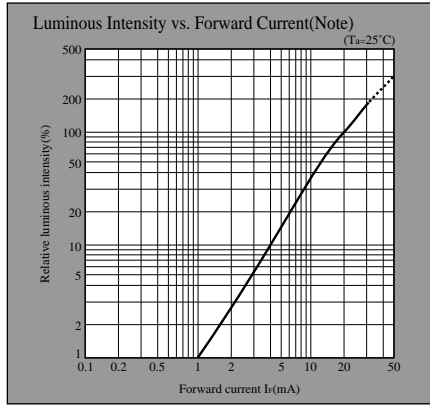
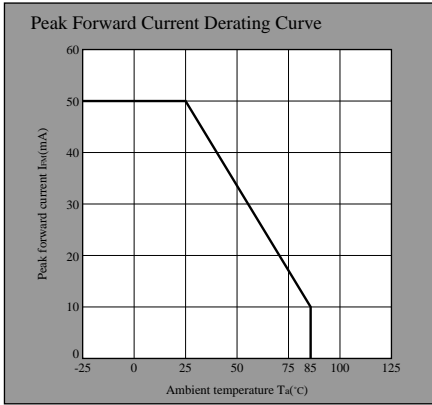
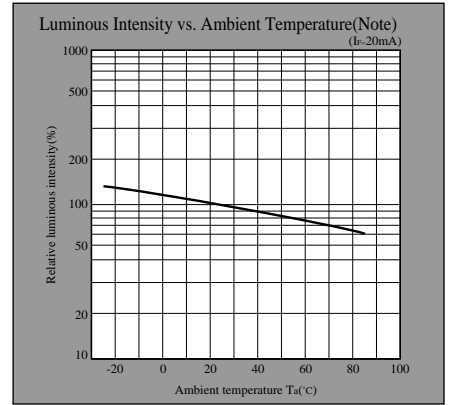
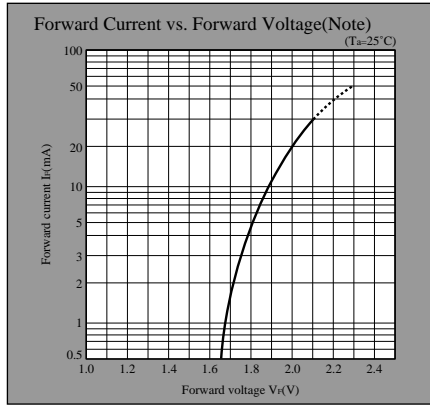
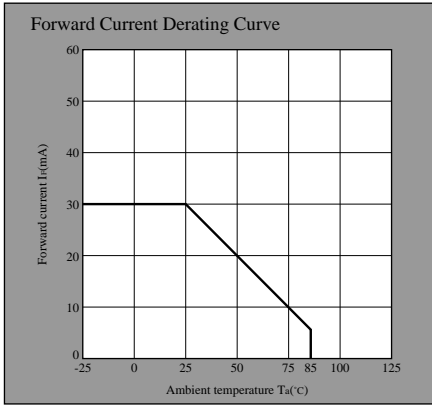

## HY series

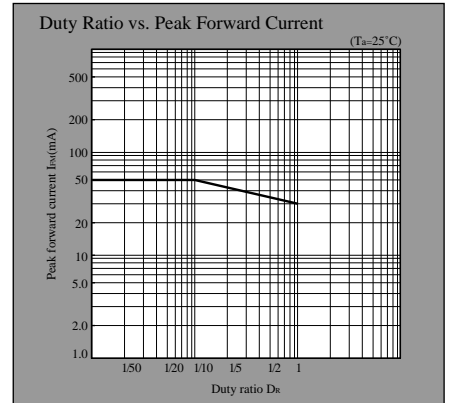
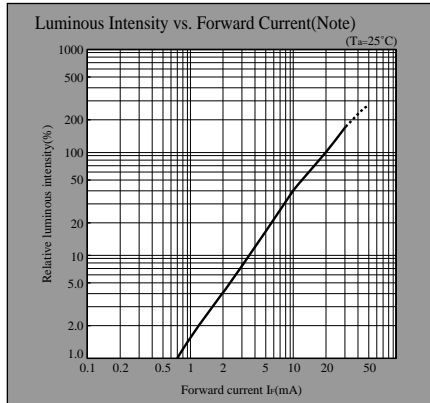
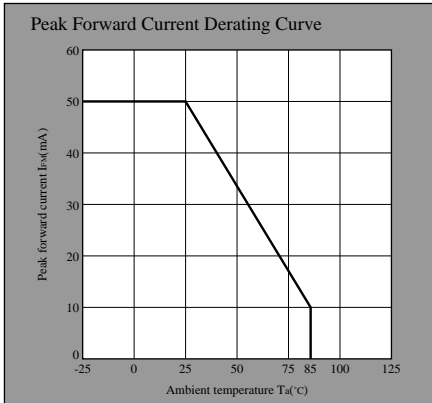
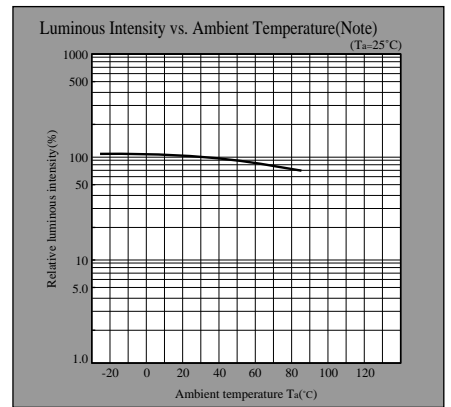
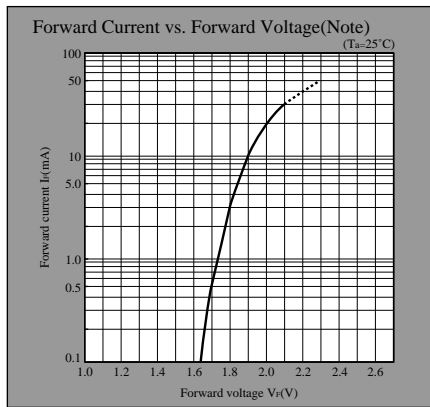
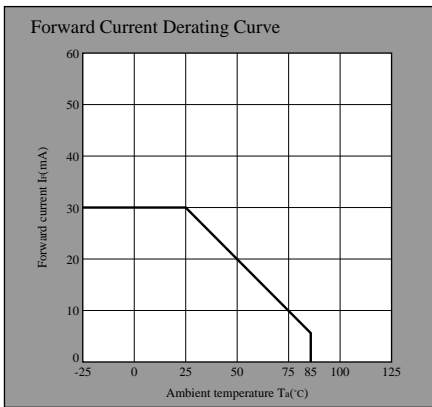

Note) Characteristics shown in diagrams are typical values. (not assurance value)

- (Notice) • In the absence of confirmation by device specification sheets, SHARP takes no responsibility for any defects that may occur in equipment using any SHARP devices shown in catalogs, data books, etc. Contact SHARP in order to obtain the latest device specification sheets before using any SHARP device.
- (Internet) • Data for sharp's optoelectronic/power device is provided for internet. (Address <http://www.sharp.co.jp/ecg/>)

# LED Lamp Characteristics Diagrams

## EG series

Forward Current Derating Curve

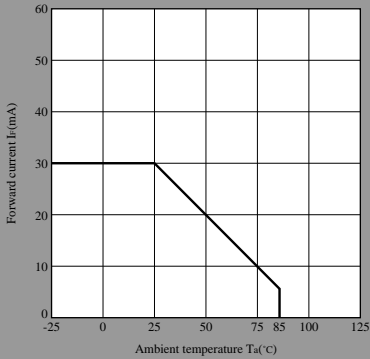

Forward Current vs. Forward Voltage(Note)

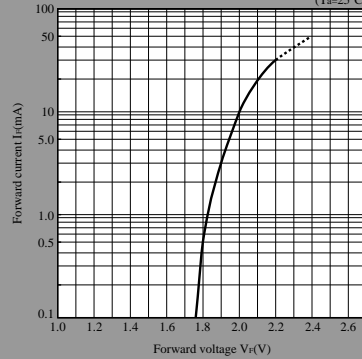

Luminous Intensity vs. Ambient Temperature(Note)

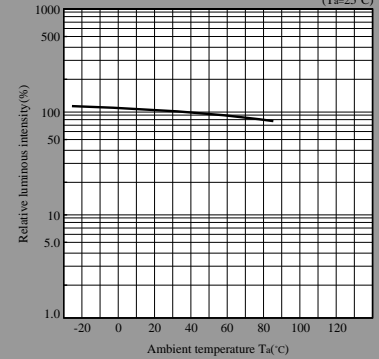

Peak Forward Current Derating Curve

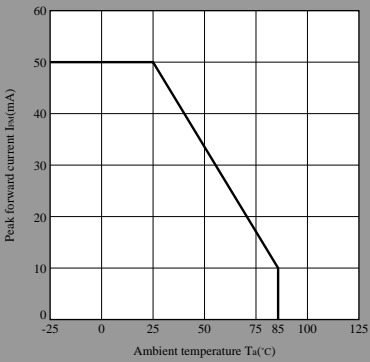

Luminous Intensity vs. Forward Current(Note)

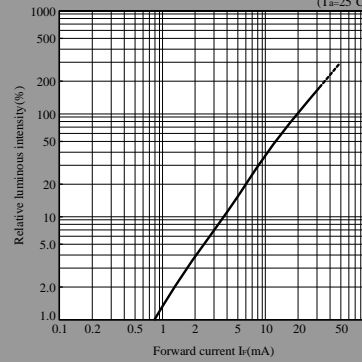

Duty Ratio vs. Peak Forward Current

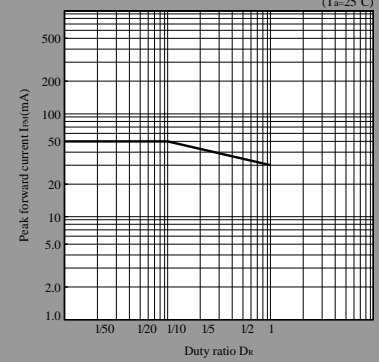

## KG series

Forward Current Derating Curve

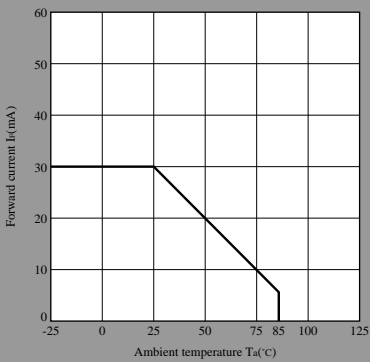

Forward Current vs. Forward Voltage(Note)

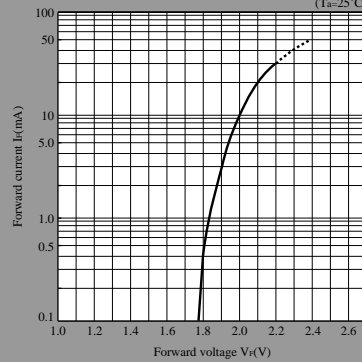

Luminous Intensity vs. Ambient Temperature(Note)

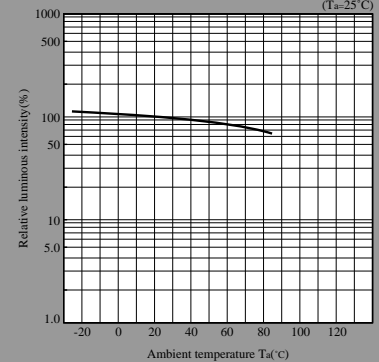

Peak Forward Current Derating Curve

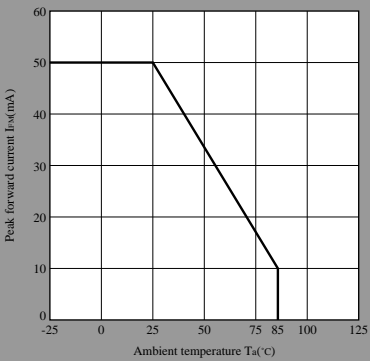

Luminous Intensity vs. Forward Current(Note)

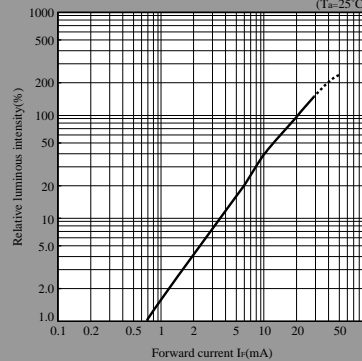

Duty Ratio vs. Peak Forward Current

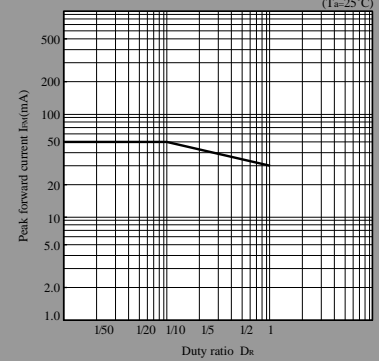

Note) Characteristics shown in diagrams are typical values. (not assurance value)

- (Notice) • In the absence of confirmation by device specification sheets, SHARP takes no responsibility for any defects that may occur in equipment using any SHARP devices shown in catalogs, data books, etc. Contact SHARP in order to obtain the latest device specification sheets before using any SHARP device.  
 (Internet) • Data for sharp's optoelectronic/power device is provided for internet.(Address <http://www.sharp.co.jp/ecg/>)