

PC924

OPIC Photocoupler for IGBT Drive of Inverter

※ Lead forming type (I type) and taping reel type (P type) are also available. (PC924I/PC924P)

※※ TÜV (VDE 0884) approved type is also available as an option.

■ Features

- Built-in direct drive circuit for IGBT drive
($I_{O1P}, I_{O2P} : 0.4A$)
- High speed response ($t_{PLH}, t_{PHL} : \text{MAX. } 2.0 \mu s$)
- Wide operating supply voltage range
($V_{CC} : 15 \text{ to } 30V \text{ at } T_a = -10 \text{ to } 60^\circ C$)
- High noise resistance type
 $CM_H : \text{MIN. } -1500V/\mu s$
 $CM_L : \text{MIN. } 1500V/\mu s$
- High isolation voltage ($V_{iso} : 5000V_{rms}$)

■ Applications

- IGBT drive for inverter control

■ Outline Dimensions

(Unit : mm)

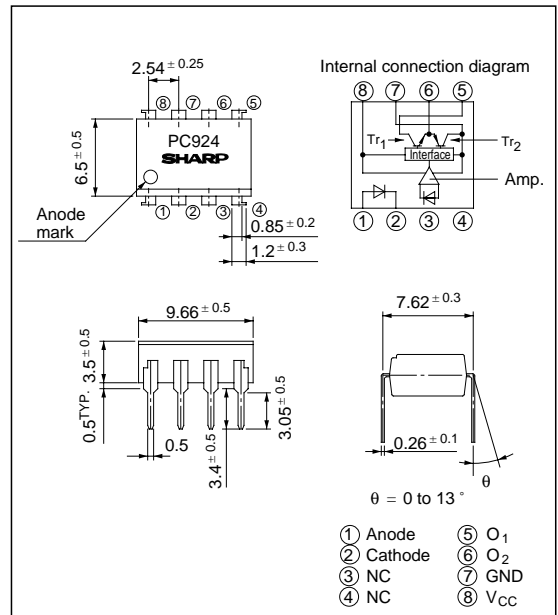

* "OPIC" (Optical IC) is a trademark of the SHARP Corporation.

An OPIC consists of a light-detecting element and signal-processing circuit integrated onto a single chip.

■ Absolute Maximum Ratings

(Unless specified, $T_a = T_{opr}$)

	Parameter	Symbol	Rating	Unit
Input	Forward current	I_F	25	mA
	Reverse voltage	V_R	6	V
	Supply voltage	V_{CC}	35	V
Output	O_1 output current	I_{O1}	0.1	A
	* 1O_1 peak output current	I_{O1P}	0.4	A
	O_2 output current	I_{O2}	0.1	A
	* 1O_2 peak output current	I_{O2P}	0.4	A
	O_1 output voltage	V_{O1}	35	V
	Power dissipation	P_O	500	mW
	Total power dissipation	P_{tot}	550	mW
	* 2 Isolation voltage	V_{iso}	5000	V_{rms}
Operating temperature	T_{opr}	-25 to +80	$^\circ C$	
Storage temperature	T_{stg}	-55 to +125	$^\circ C$	
* 3 Soldering temperature	T_{sol}	260	$^\circ C$	

* 1 Pulse width $\leq 0.15 \mu s$,

Duty ratio : 0.01

* 2 40 to 60% RH, AC for 1 minute, $T_a = 25^\circ C$

* 3 For 10 seconds

Electro-optical Characteristics

(Ta = T_{opr} unless otherwise specified)

Parameter		Symbol	*4 Conditions	MIN.	TYP.	MAX.	Unit	Fig.			
Input	Forward voltage	V _{F1}	Ta = 25°C, I _F = 20mA	-	1.2	1.4	V	-			
		V _{F2}	Ta = 25°C, I _F = 0.2mA	0.6	0.9	-	V	-			
	Reverse current	I _R	Ta = 25°C, V _R = 4V	-	-	10	μA	-			
	Terminal capacitance	C _t	Ta = 25°C, V = 0, f = 1kHz	-	30	250	pF	-			
Output	Operating supply voltage	V _{CC}	Ta = - 10 to 60°C	15	-	30	V	-			
				15	-	24	V				
	O ₁ low level output voltage	V _{O1L}	V _{CC1} = 12V, V _{CC2} = - 12V I _{O1} = 0.1A, I _F = 10mA	-	0.2	0.4	V	1			
	O ₂ high level output voltage	V _{O2H}	V _{CC} = V _{O1} = 24V, I _{O2} = - 0.1A, I _F = 10mA	18	21	-	V	2			
	O ₂ low level output voltage	V _{O2L}	V _{CC} = 24V, I _{O2} = 0.1A, I _F = 0	-	1.2	2.0	V	3			
	O ₁ leak current	I _{O1L}	Ta = 25°C, V _{CC} = V _{O1} = 35V, I _F = 0	-	-	500	μA	4			
	O ₂ leak current	I _{O2L}	Ta = 25°C, V _{CC} = V _{O2} = 35V, I _F = 10mA	-	-	500	μA	5			
	High level supply current	I _{CCH}	Ta = 25°C, V _{CC} = 24V, I _F = 10mA	-	6	10	mA	6			
			V _{CC} = 24V, I _F = 10mA	-	-	14	mA				
Low level supply current	I _{CCL}	Ta = 25°C, V _{CC} = 24V, I _F = 0	-	8	13	mA	6				
		V _{CC} = 24V, I _F = 0	-	-	17	mA					
Transfer characteristics	*5 “Low→High” threshold input current	I _{FLH}	Ta = 25°C, V _{CC} = 24V	1.0	4.0	7.0	mA	7			
			V _{CC} = 24V	0.6	-	10.0	mA				
	Response time	Isolation resistance	R _{ISO}	Ta = 25°C, DC = 500V, 40 to 60% RH	5 x 10 ¹⁰	10 ¹¹	-	Ω	-		
				“Low→High” propagation delay time	t _{PLH}	-	1.0	2.0	μs	8	
				“High→Low” propagation delay time	t _{PHL}	Ta = 25°C, V _{CC} = 24V, I _F = 10mA	-	1.0	2.0		μs
				Rise time	t _r	R _C = 47 Ω, C _G = 3,000pF	-	0.2	0.5		μs
	Fall time	t _f		-	0.2	0.5	μs				
	Instantaneous common mode rejection voltage “Output: High level”	CM _H	Ta = 25°C, V _{CM} = 600V(peak) I _F = 10mA, V _{CC} = 24V, ΔV _{O2H} = 2.0V	-	- 30	-	kV/μs	9			
Instantaneous common mode rejection voltage “Output: Low level”			CM _L	Ta = 25°C, V _{CM} = 600V(peak) I _F = 0, V _{CC} = 24V, ΔV _{O2L} = 2.0V	-	30	-		kV/μs		

*4 When measuring output and transfer characteristics, connect a by-pass capacitor (0.01 μF or more) between V_{CC} and GND near the device.

*5 I_{FLH} represents forward current when output goes from “Low” to “High” .

Truth Table

Input	O ₂ Output	Tr. 1	Tr. 2
ON	High level	ON	OFF
OFF	Low level	OFF	ON

■ Test Circuit

Fig. 1

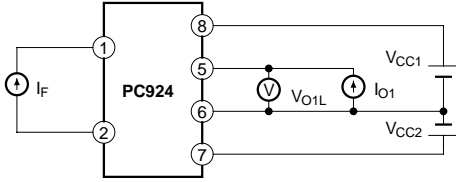

Fig. 3

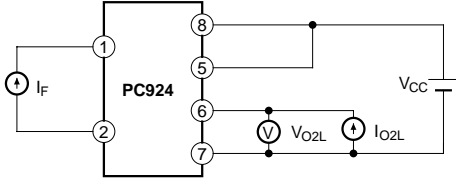

Fig. 5

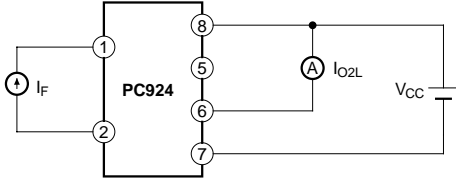

Fig. 7

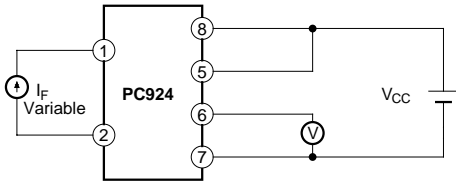

Fig. 9

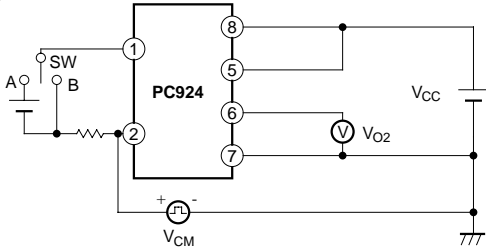

Fig. 2

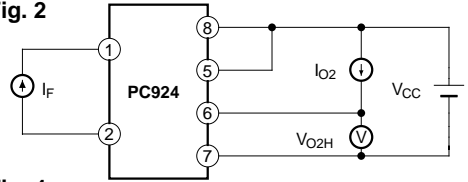

Fig. 4

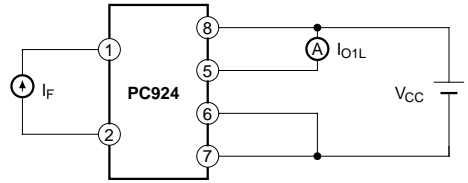

Fig. 6

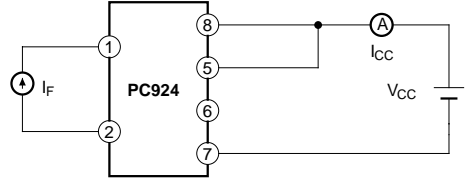

Fig. 8

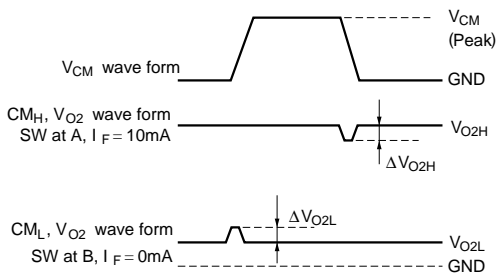
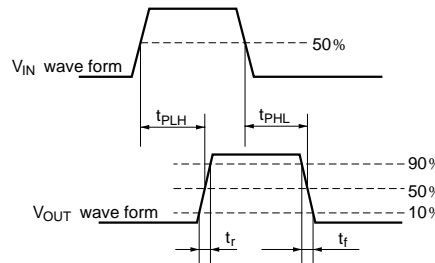
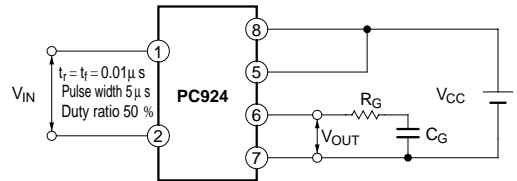

Fig.10 Forward Current vs. Ambient Temperature

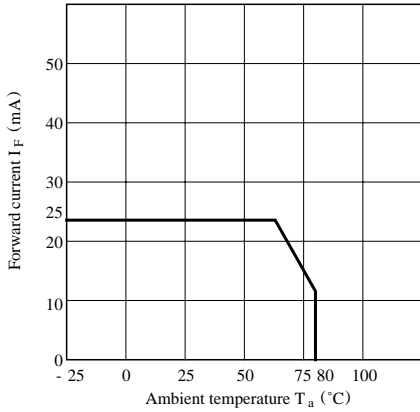

Fig.11 Power Dissipation vs. Ambient Temperature

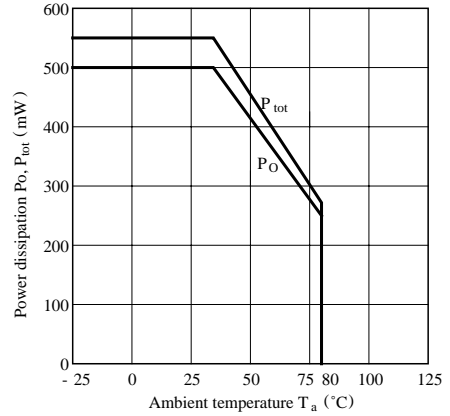

Fig.12 Forward Current vs. Forward Voltage

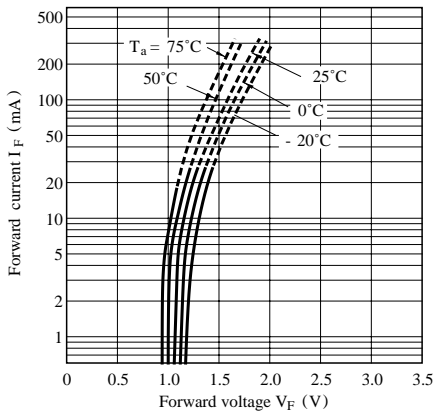

Fig.13 Relative Threshold Input Current vs. Supply Voltage

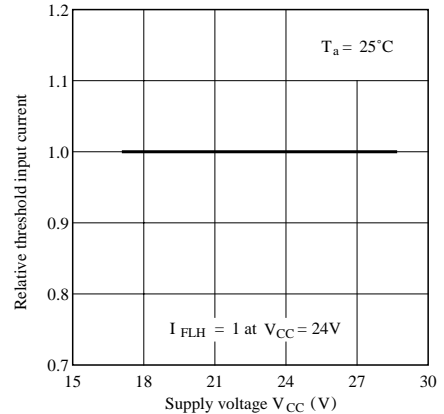

Fig.14 Relative Threshold Input Current vs. Ambient Temperature

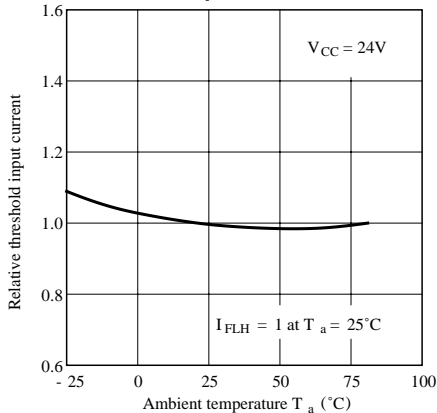

Fig.15 O₁ Low Level Output Voltage vs. O₁ Output Current

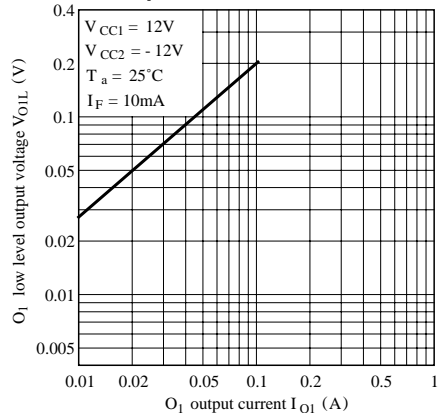

Fig.16 O₁ Low Level Output Voltage vs. Ambient Temperature

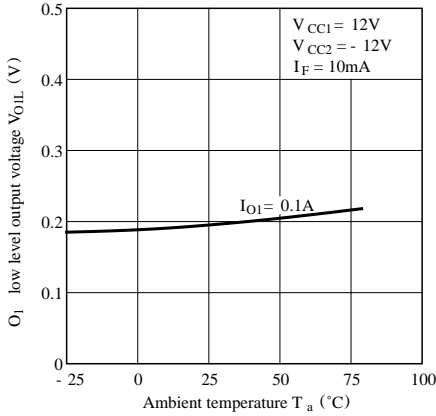

Fig.17 O₂ High Level Output Voltage vs. Supply Voltage

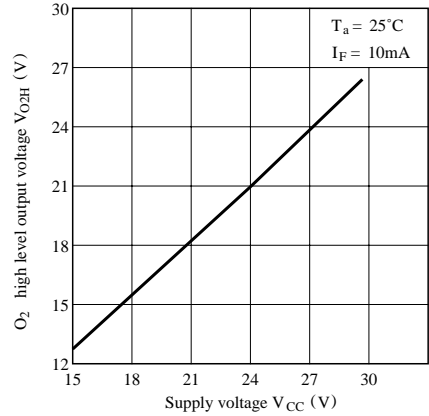

Fig.18 O₂ High Level Output Voltage vs. Ambient Temperature

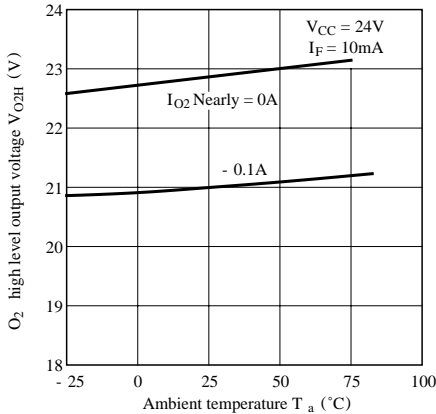

Fig.19 O₂ Low Level Output Voltage vs. O₂ Output Current

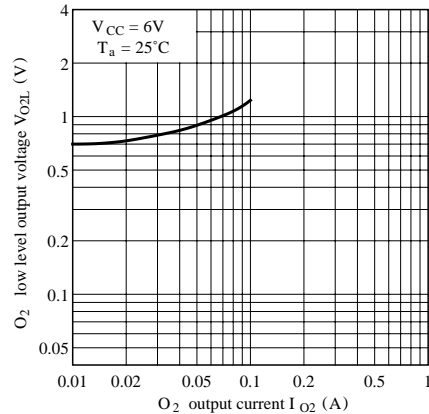

Fig.20 O₂ Low Level Output Voltage vs. Ambient Temperature

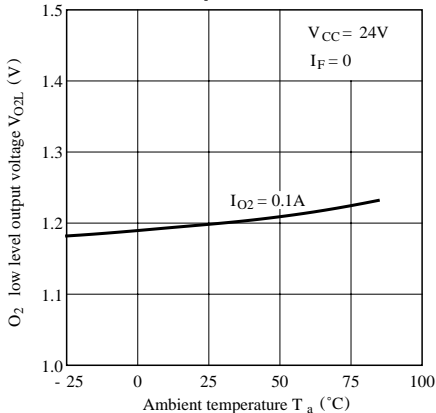

Fig.21 High Level Supply Current vs. Supply Voltage

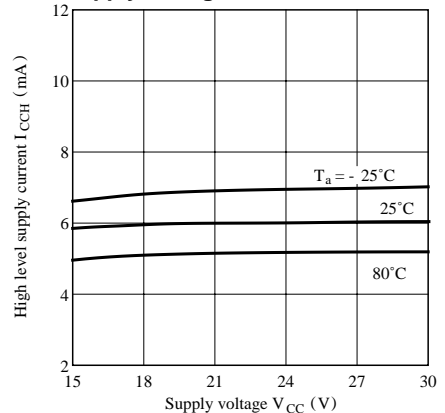

Fig.22 Low Level Supply Current vs. Supply Voltage

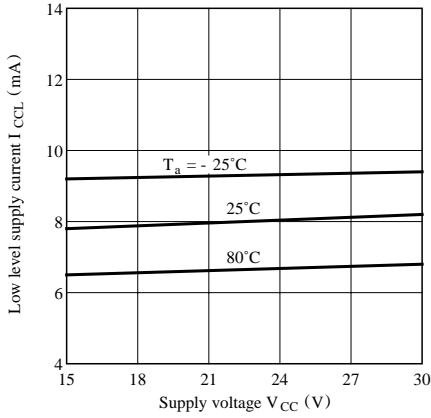

Fig.23 Propagation Delay Time vs. Forward Current

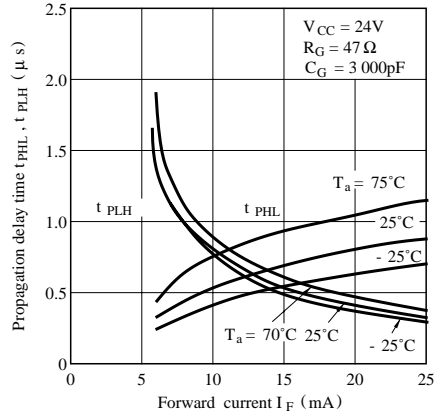
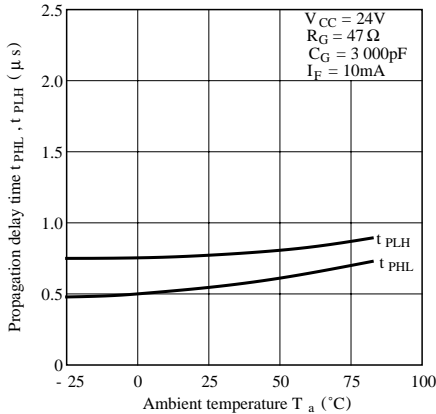
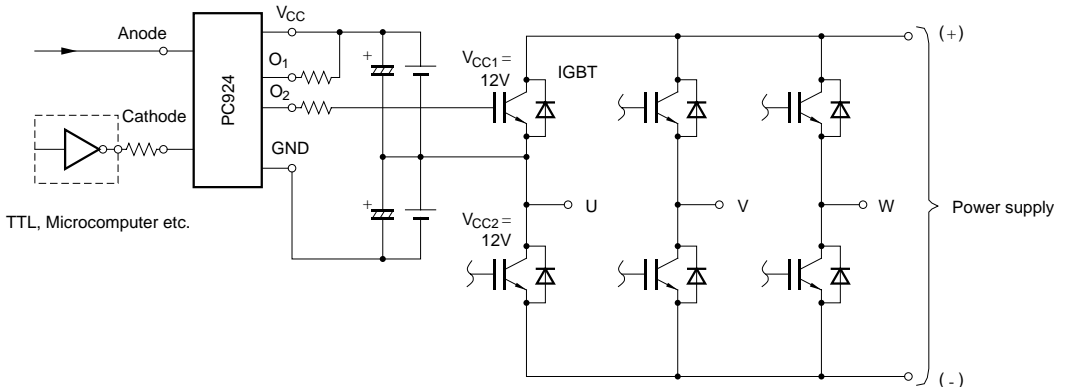

Fig.24 Propagation Delay Time vs. Ambient Temperature



■ **Application Circuit (IGBT Drive for Inverter)**



● Please refer to the chapter “Precautions for Use”