

> **Features**

- High Current
- Low On-Resistance
- No Secondary Breakdown
- Low Driving Power
- High Forward Transconductance
- Avalanche Proof

> **Applications**

- Motor Control
- General Purpose Power Amplifier
- DC-DC converters

> **Outline Drawing**

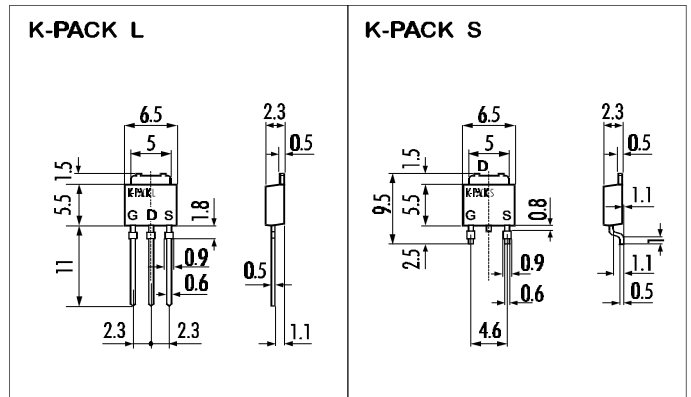

> **Maximum Ratings and Characteristics**

- Absolute Maximum Ratings ( $T_C=25^\circ\text{C}$ ), unless otherwise specified

| Item                                     | Symbol        | Rating     | Unit             |
|--|---------------|------------|------------------|
| Drain-Source-Voltage                     | $V_{DS}$      | 60         | V                |
| Drain-Gate-Voltage( $R_{GS}=20K\Omega$ ) | $V_{DGR}$     | 60         | V                |
| Continous Drain Current                  | $I_D$         | 10         | A                |
| Pulsed Drain Current                     | $I_{D(puls)}$ | 40         | A                |
| Gate-Source-Voltage                      | $V_{GS}$      | $\pm 20$   | V                |
| Max. Power Dissipation                   | $P_D$         | 20         | W                |
| Operating and Storage Temperature Range  | $T_{ch}$      | 150        | $^\circ\text{C}$ |
|  | $T_{stg}$     | -55 ~ +150 | $^\circ\text{C}$ |

> **Equivalent Circuit**

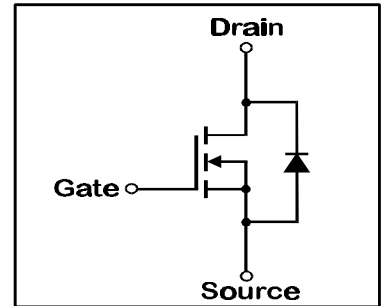

- Electrical Characteristics ( $T_C=25^\circ\text{C}$ ), unless otherwise specified

| Item   | Symbol        | Test conditions  | Min. | Typ. | Max. | Unit          |
|--|---------------|--|------|------|------|---------------|
| Drain-Source Breakdown-Voltage                       | $V_{(BR)DSS}$ | $I_D=1\text{mA}$ $V_{GS}=0\text{V}$                          | 60   |      |      | V             |
| Gate Threshold Voltage                               | $V_{GS(th)}$  | $I_D=1\text{mA}$ $V_{DS}=V_{GS}$                             | 1,0  | 1,5  | 2,5  | V             |
| Zero Gate Voltage Drain Current                      | $I_{DSS}$     | $V_{DS}=60\text{V}$ $T_{ch}=25^\circ\text{C}$                |      | 10   | 500  | $\mu\text{A}$ |
|  |               | $V_{GS}=0\text{V}$ $T_{ch}=125^\circ\text{C}$                |      | 0,2  | 1,0  | mA            |
| Gate Source Leakage Current                          | $I_{GSS}$     | $V_{GS}=\pm 20\text{V}$ $V_{DS}=0\text{V}$                   |      | 10   | 100  | nA            |
| Drain Source On-State Resistance                     | $R_{DS(on)}$  | $I_D=5\text{A}$ $V_{GS}=4\text{V}$                           |      | 0,11 | 0,16 | $\Omega$      |
|  |               | $I_D=5\text{A}$ $V_{GS}=10\text{V}$                          |      | 0,07 | 0,1  | $\Omega$      |
| Forward Transconductance                             | $g_{fs}$      | $I_D=5\text{A}$ $V_{DS}=25\text{V}$                          | 4    | 8    |      | S             |
| Input Capacitance                                    | $C_{iss}$     | $V_{DS}=25\text{V}$  |      | 500  | 750  | pF            |
| Output Capacitance                                   | $C_{oss}$     | $V_{GS}=0\text{V}$   |      | 200  | 300  | pF            |
| Reverse Transfer Capacitance                         | $C_{rss}$     | $f=1\text{MHz}$  |      | 80   | 120  | pF            |
| Turn-On-Time $t_{on}$ ( $t_{on}=t_{d(on)}+t_r$ )     | $t_{d(on)}$   | $V_{CC}=30\text{V}$  |      | 10   | 15   | ns            |
|  |               | $I_D=5\text{A}$  |      | 20   | 30   | ns            |
| Turn-Off-Time $t_{off}$ ( $t_{off}=t_{d(off)}+t_f$ ) | $t_{d(off)}$  | $V_{GS}=10\text{V}$  |      | 100  | 150  | ns            |
|  |               | $R_{GS}=25\Omega$  |      | 50   | 75   | ns            |
| Avalanche Capability                                 | $I_{AV}$      | $L=100\mu\text{H}$ $T_{ch}=25^\circ\text{C}$                 | 10   |      |      | A             |
| Continous Reverse Drain Current                      | $I_{DR}$      |  |      |      | 10   | A             |
| Pulsed Reverse Drain Current                         | $I_{DRM}$     |  |      |      | 40   | A             |
| Diode Forward On-Voltage                             | $V_{SD}$      | $I_F=2I_{DR}$ $V_{GS}=0\text{V}$ $T_{ch}=25^\circ\text{C}$   |      | 1,2  |      | V             |
| Reverse Recovery Time                                | $t_{rr}$      | $I_F=I_{DR}$ $V_{GS}=0\text{V}$                              |      | 100  |      | ns            |
| Reverse Recovery Charge                              | $Q_{rr}$      | $-di_F/dt=100\text{A}/\mu\text{s}$ $T_{ch}=25^\circ\text{C}$ |      | 0,15 |      | $\mu\text{C}$ |

- Thermal Characteristics

| Item               | Symbol         | Test conditions | Min. | Typ. | Max. | Unit                      |
|--------------------|----------------|-----------------|------|------|------|---------------------------|
| Thermal Resistance | $R_{th(ch-a)}$ | channel to air  |      |      |      | $^\circ\text{C}/\text{W}$ |
|                    | $R_{th(ch-c)}$ | channel to case |      |      | 6,25 | $^\circ\text{C}/\text{W}$ |

> Characteristics

Typical Output Characteristics

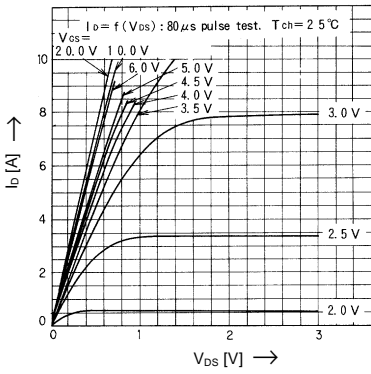

Drain-Source-On-State Resistance vs. Tch

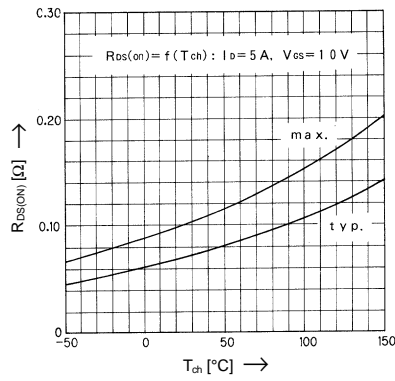

Typical Transfer Characteristics

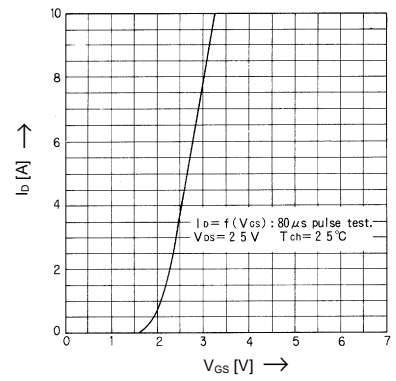

Typical Drain-Source-On-State-Resistance vs. Id

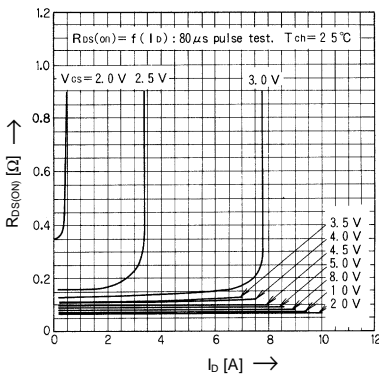

Typical Forward Transconductance vs. Id

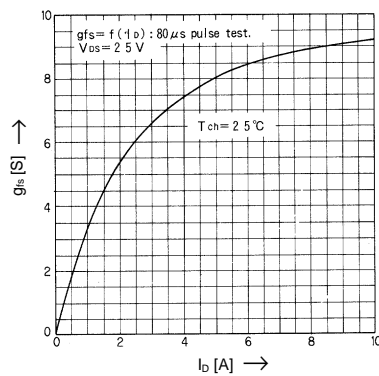

Gate Threshold Voltage vs. Tch

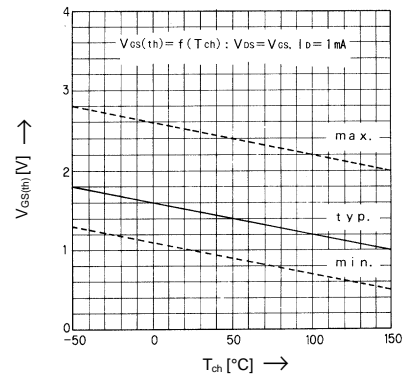

Typical Capacitance vs. Vds

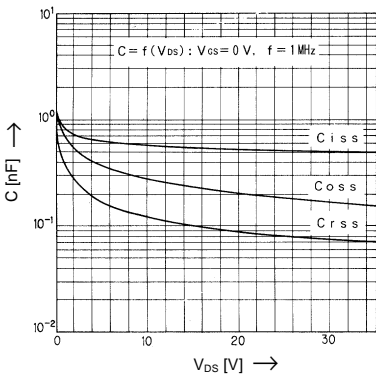

Typical Input Charge

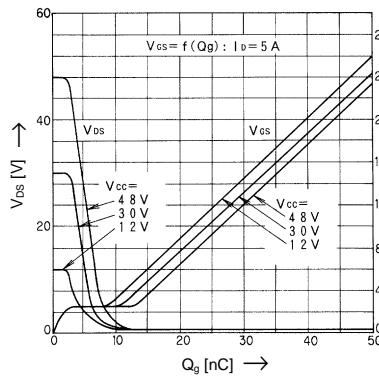

Forward Characteristics of Reverse Diode

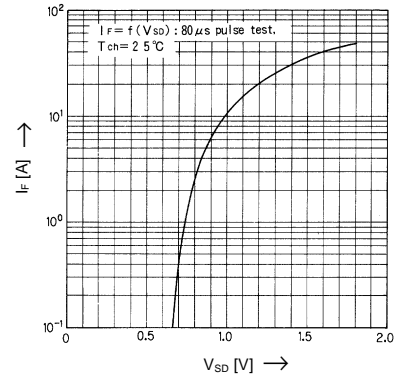

Allowable Power Dissipation vs. Tch

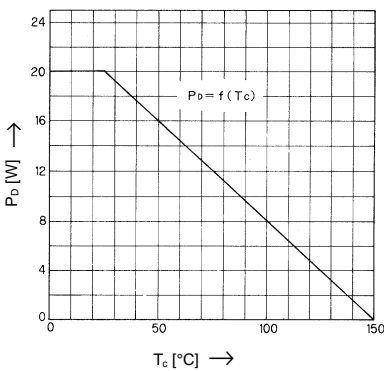

Safe operation area

