

SPECIFICATION

DEVICE NAME : Power MOSFET

TYPE NAME : 2SK2100-01MR

SPEC. No. :

Fuji Electric Co.,Ltd.

This Specification is subject to change without notice.

	DATE	NAME	APPROVED	Fuji Electric Co.,Ltd.		
DRAWN				DWG. NO.	1/11	
CHECKED						

1. Scope
This specifies Fuji power MOSFET 2SK2100-01MR
2. Construction N-channel enhancement mode power MOSFET
3. Application for switching
4. Outview TO-220F Outview See to 5/11 page
5. Absolute maximum ratings at Tc=25°C (unless otherwise specified)

Description	Symbol	Characteristics	Unit	Remarks
Drain-source voltage	V_{DS}	800	V	
Drain-gate voltage	V_{DGR}	800	V	$R_{GS} = 20 K\Omega$
Continuous Drain current	I_D	± 4	A	
Pulsed drain current	I_{Dpul}	± 16	A	
Gate-source voltage	V_{GS}	± 30	V	
Maximum power dissipation	P_D	40	W	
Operating and storage temperature range	T_{ch}	150	°C	
	T_{stg}	-55 ~ +150	°C	

6. Electrical characteristics at Tc=25°C (unless otherwise specified)

Static ratings

Description	Symbol	Conditions	Characteristics			Unit
			Min.	Typ.	Max.	
Drain-source breakdown voltage	BV_{DSS}	$I_D = 1mA$ $V_{GS} = 0V$	800			V
Gate threshold voltage	$V_{GS(th)}$	$I_D = 1mA$ $V_{DS} = V_{GS}$	2.5	3.0	3.5	V
Zero gate voltage drain current	I_{DSS}	$V_{DS} = 800V$ $V_{GS} = 0V$	$T_{ch} = 25^\circ C$	10	500	μA
	I_{DSS}		$T_{ch} = 125^\circ C$	0.2	1.0	mA
Gate-source leakage current	I_{GSS}	$V_{GS} = \pm 30V$ $V_{DS} = 0V$		10	100	nA
Drain-source on-state resistance	$R_{DS(on)}$	$I_D = 2A$ $V_{GS} = 10V$		2.5	3.3	Ω

Fuji Electric Co., Ltd.

DWG. NO.

2/11

Y 0257-R-003a

Dynamic ratings

Description	Symbol	Conditions	Characteristics			Unit
			Min.	Typ.	Max.	
Forward transconductance	g_{fs}	$I_D = 2\text{ A}$ $V_{OS} = 25\text{ V}$	2.0	4.4		S
Input capacitance	C_{iss}	$V_{OS} = 25\text{ V}$ $V_{GS} = 0\text{ V}$ $f = 1\text{ MHz}$		1000	1500	pF
Output capacitance	C_{oss}			90	135	pF
Reverse transfer capacitance	C_{rss}			25	40	pF
Turn-on time	$t_{d(on)}$	$V_{CC} = 600\text{ V}$ $V_{GS} = 10\text{ V}$ $I_D = 3\text{ A}$ $R_{GS} = 10\ \Omega$		20	30	ns
	t_r			10	15	ns
Turn-off time	$t_{d(off)}$			60	90	ns
	t_f			15	25	ns

Reverse diode

Description	Symbol	Conditions	Characteristics			Unit
			Min.	Typ.	Max.	
Avalanche capability	I_{AV}	$L = 100\ \mu\text{H}$, $T_{CH} = 25^\circ\text{C}$ * See Fig1 and 2	4			A
Diode forward on-voltage	V_{SD}	$I_F = 2 \times I_{DR}$ $V_{GS} = 0\text{ V}$, $T_{CH} = 25^\circ\text{C}$		1.0	1.5	V
Reverse recovery time	t_{rr}	$I_F = I_{DR}$ $V_{GS} = 0\text{ V}$ $-di_F/dt = 100\text{ A}/\mu\text{s}$ $T_{CH} = 25^\circ\text{C}$				ns
Reverse recovery charge	Q_{rr}					μC

7. Thermal resistance

Description	Symbol	Conditions	Characteristics			Unit
			Min.	Typ.	Max.	
Thermal resistance	$R_{th_{c-h-c}}$				3.125	$^\circ\text{C}/\text{W}$
	$R_{th_{c-h-a}}$				62.5	$^\circ\text{C}/\text{W}$

Fuji Electric Co., Ltd.

DWG.NO.

3/11

Y 0257-R-003a

Fig.1 Test circuit

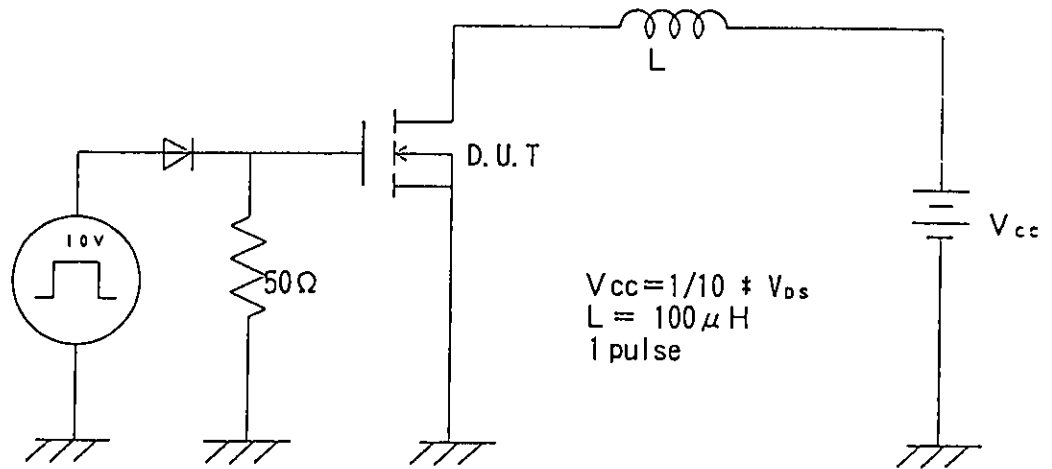
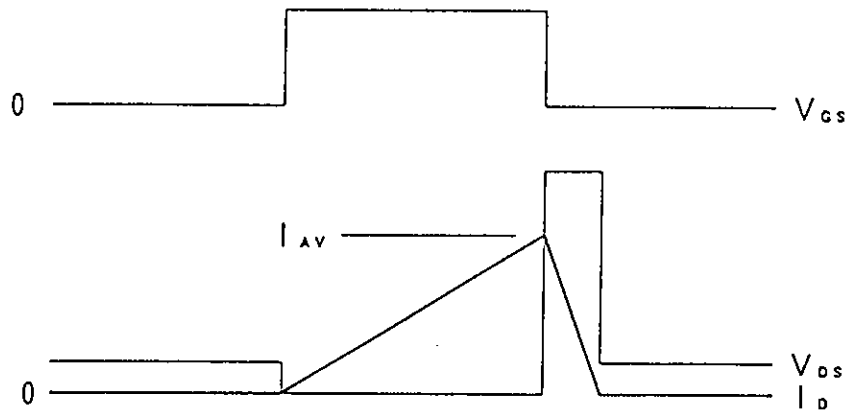
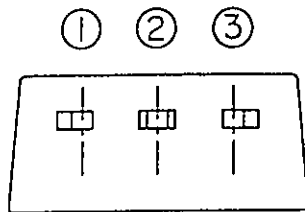
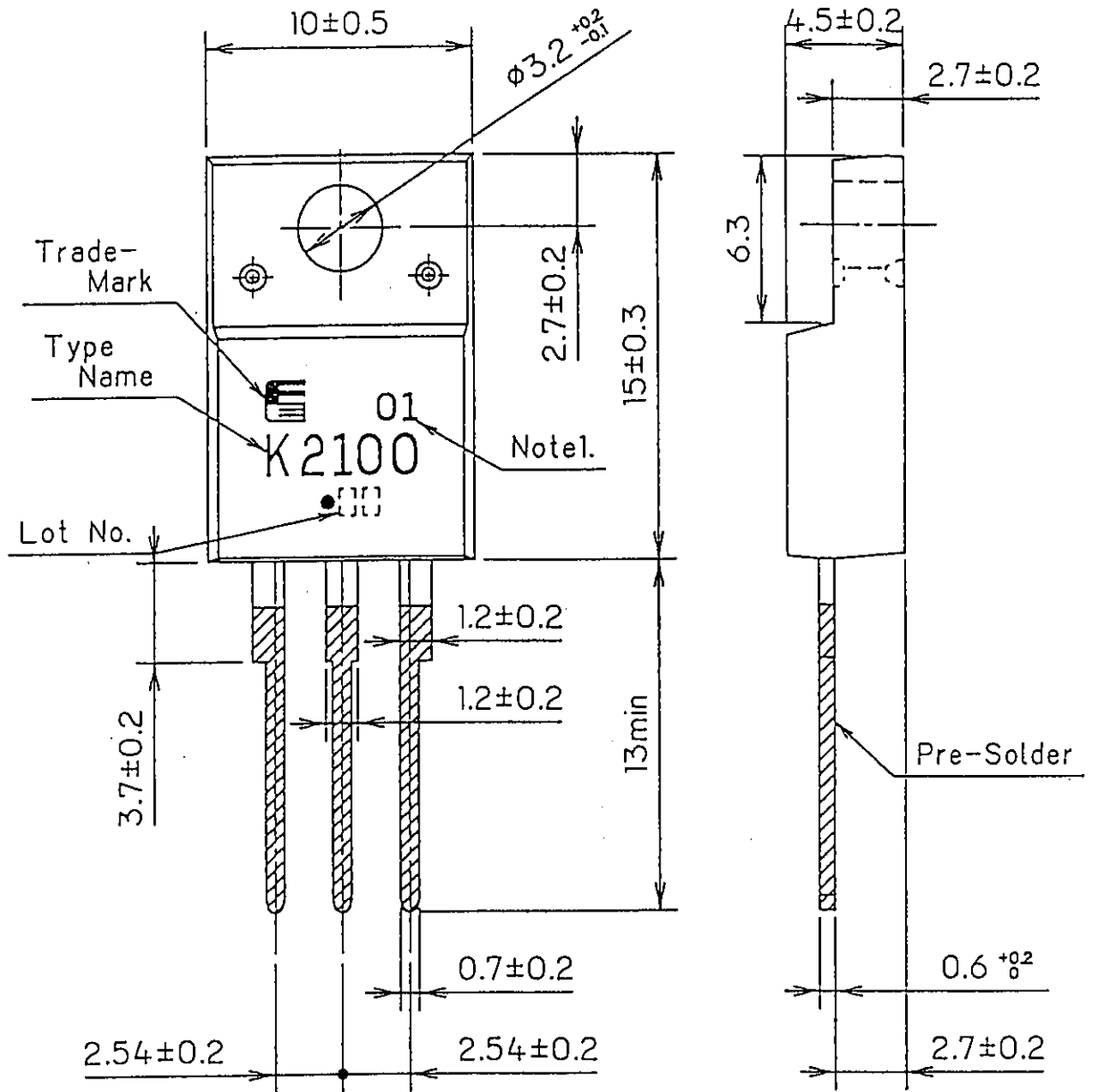

Fig.2 Operating waveforms



FUJI POWER MOS FET

TYPE : 2SK2100-01MR



CONNECTION

- ① GATE
- ② DRAIN
- ③ SOURCE

Note 1. Guaranteed mark of avalanche ruggedness.

DIMENSIONS ARE IN MILLIMETERS.

Fuji Electric Co., Ltd.

DWG. NO.

5/11

Y 0257-R-003a

Power Dissipation
 $PD=f(TC)$

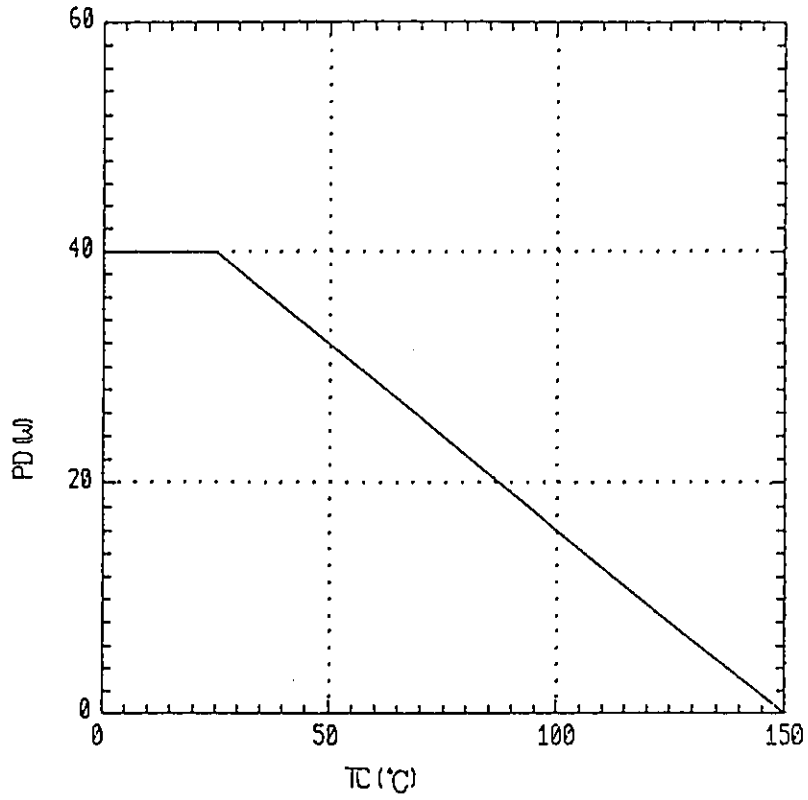

Safe operating area
 $ID=f(VDS): D=0.01, Tc=25^{\circ}C$

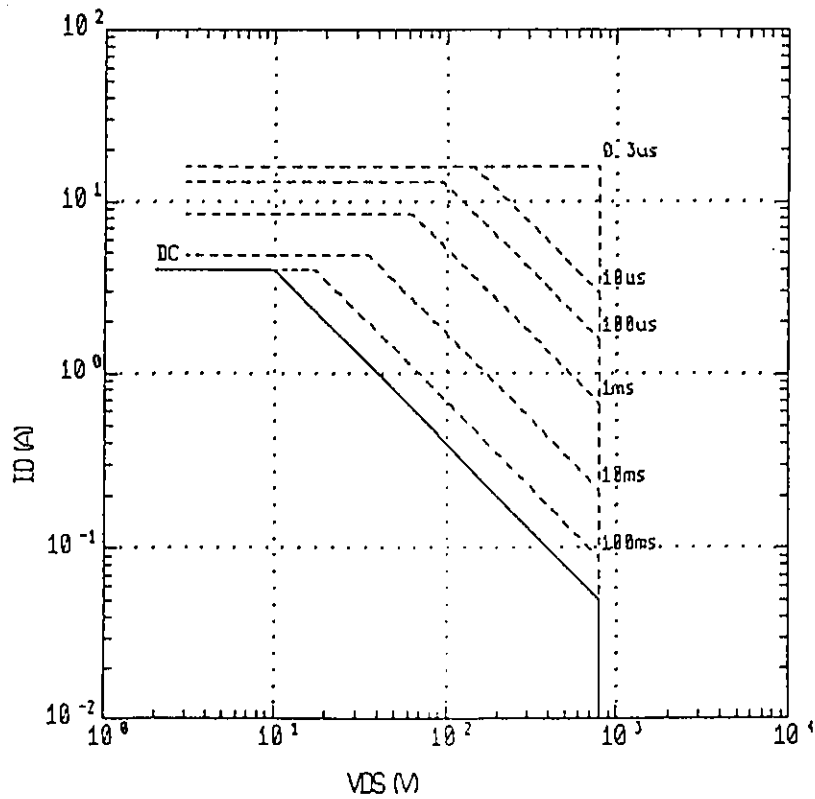

Typical output characteristics
 $I_D = f(V_{DS})$: 80 μ s pulse test, $T_{ch} = 25^\circ\text{C}$

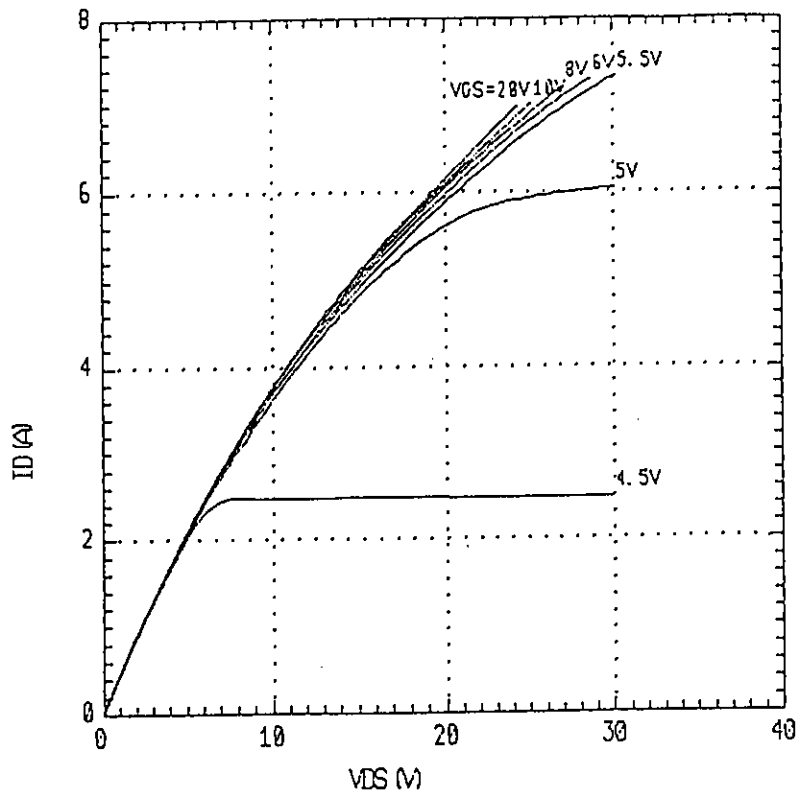

Typical Transfer Characteristics
 $I_D = f(V_{GS})$: 80 μ s pulse test, $V_{DS} = 25\text{V}$, $T_{ch} = 25^\circ\text{C}$

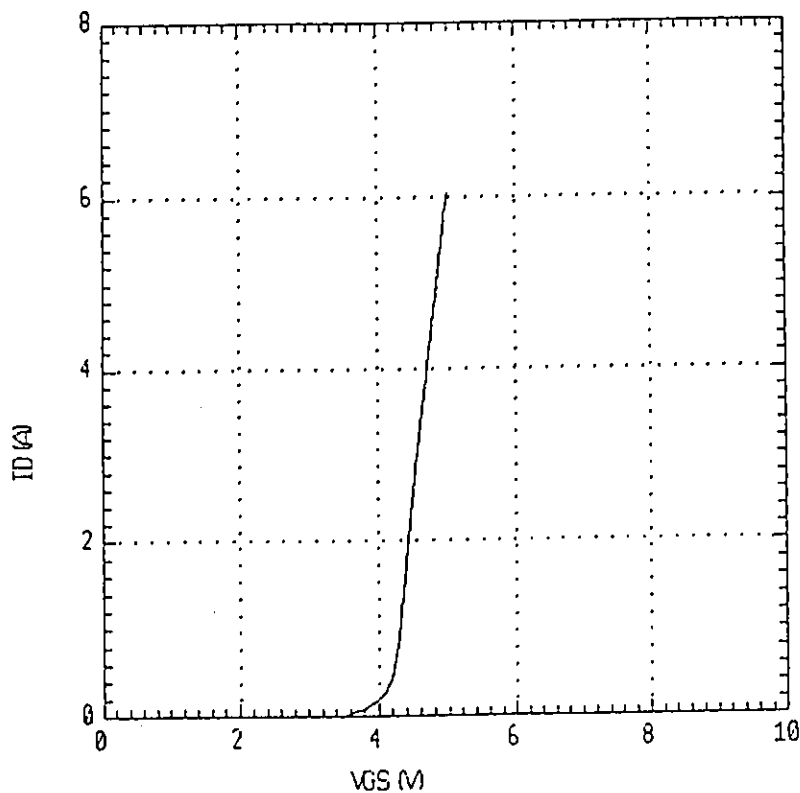

Typical Transconductance
 $g_{fs}=f(I_D)$: 80 μ s pulse test, $V_{DS}=25V$, $T_{ch}=25^\circ C$

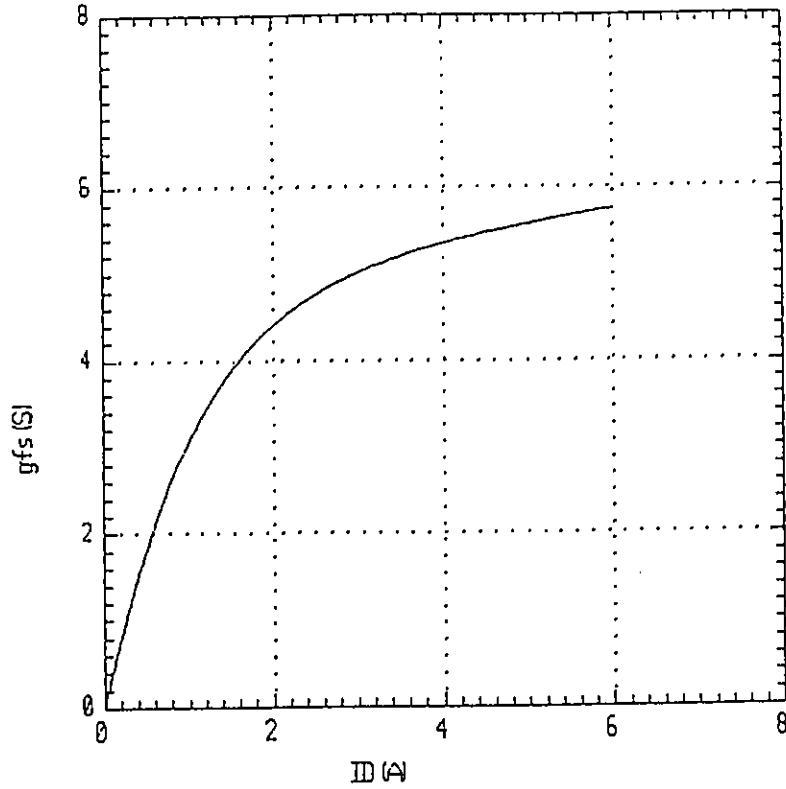

Typical Drain-source on-state resistance
 $R_{DS(on)}=f(I_D)$: 80 μ s pulse test, $T_{ch}=25^\circ C$

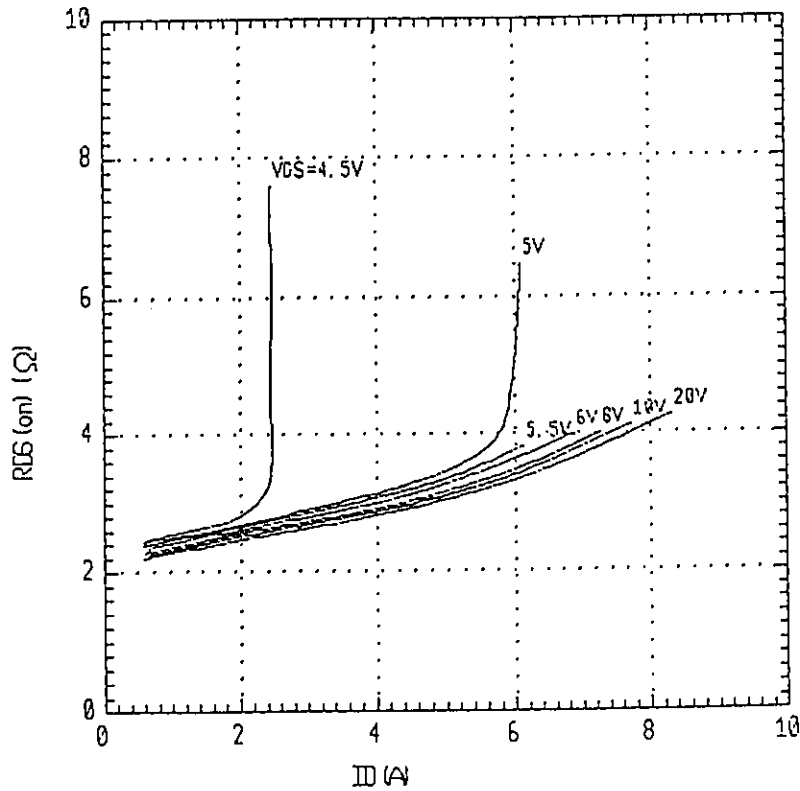

Drain-source on-state resistance
 $R_{DS(on)} = f(T_{ch}) : I_D = 2A, V_{GS} = 10V$

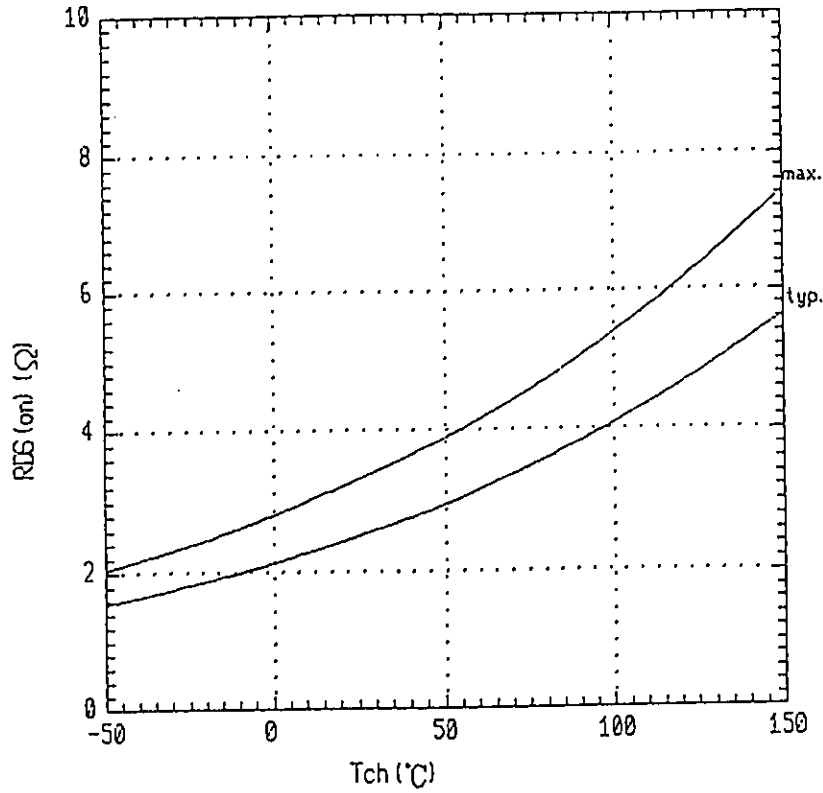

Gate threshold voltage
 $V_{GS(th)} = f(T_{ch}) : V_{DS} = V_{GS}, I_D = 1mA$

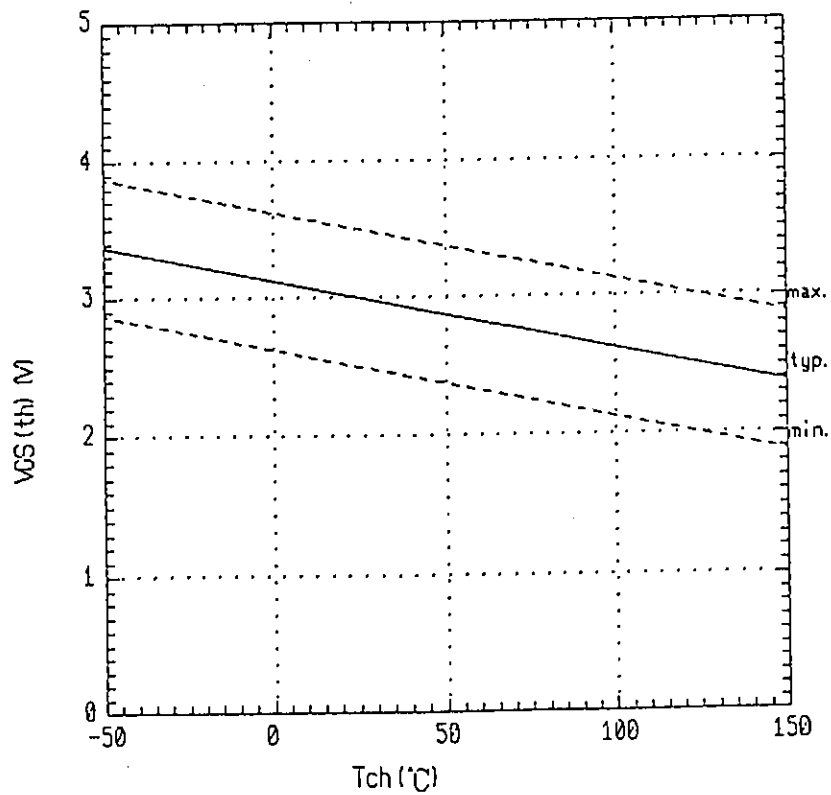

Typical gate charge characteristics
 $V_{GS} = f(Q_g) : I_D = 4A$

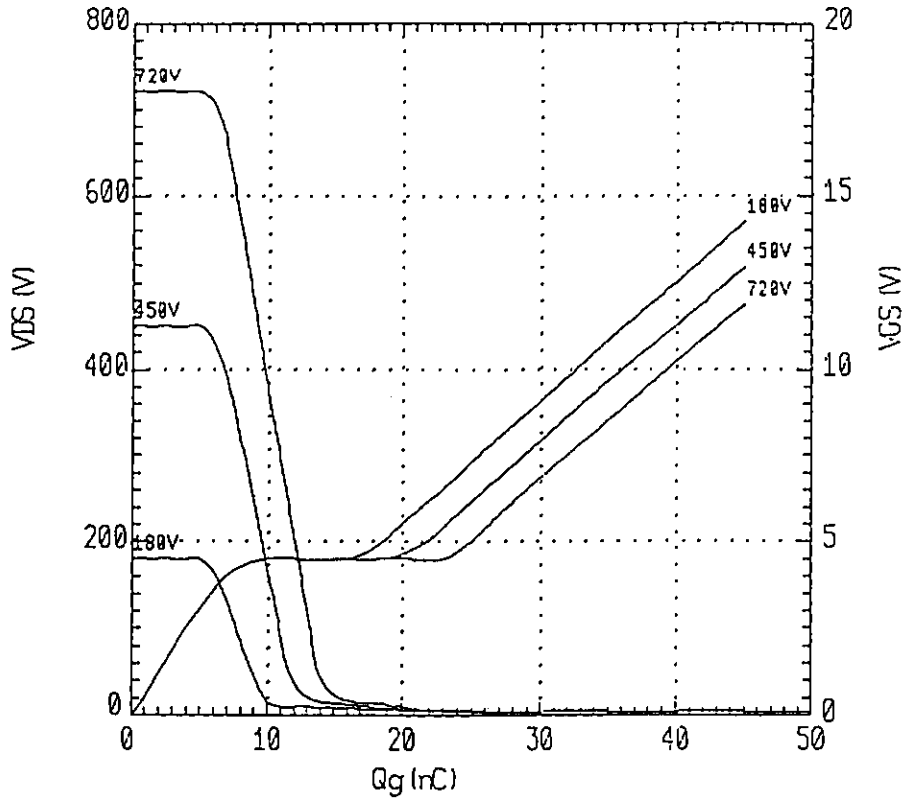

Typical capacitances
 $C = f(V_{DS}) : V_{GS} = 0V, f = 1MHz$

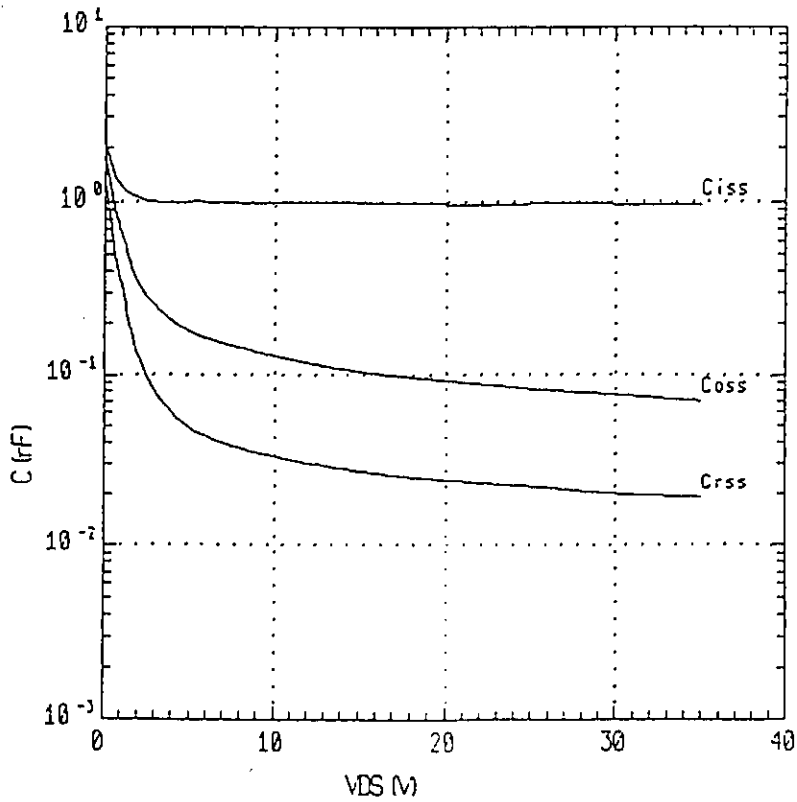

Fuji Electric Co., Ltd.

DWG. NO.

10/11

Forward characteristic of reverse diode
 $I_F = f(V_{SD}) : 80 \mu s$ pulse test

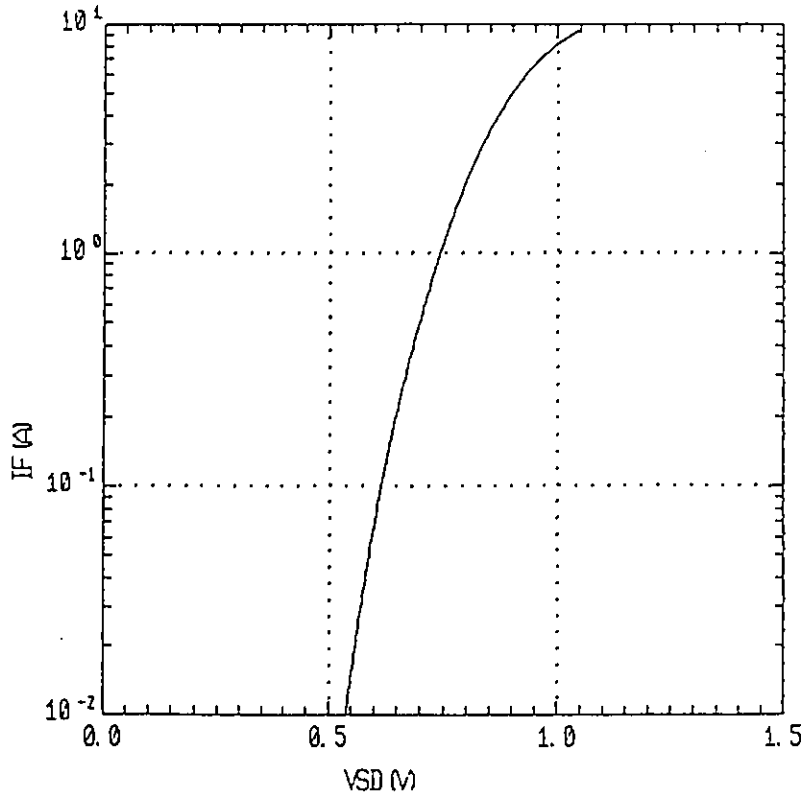

Transient thermal
 impedance $Z_{thch-c} = f(t)$ parameter: $D = t/T$

