

> **Features**

- High Current
- Low On-Resistance
- No Secondary Breakdown
- Low Driving Power
- Avalanche Rated

> **Applications**

- Motor Control
- General Purpose Power Amplifier
- DC-DC converters

> **Outline Drawing**

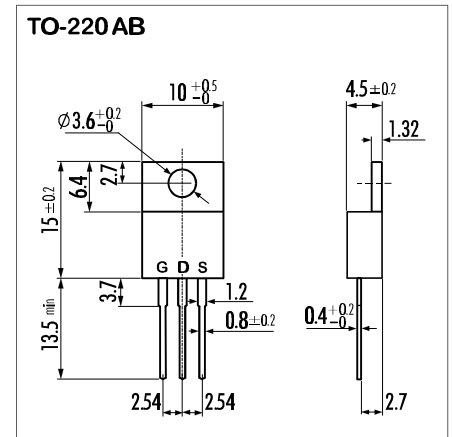

> **Maximum Ratings and Characteristics**

- Absolute Maximum Ratings (T_C=25°C), unless otherwise specified

Item	Symbol	Characteristics	Unit
Drain-Source-Voltage	V _{DS}	60	V
Continous Drain Current	I _D	±45	A
Pulsed Drain Current	I _{D(puls)}	±180	A
Gate-Source-Voltage	V _{GS}	±20	V
Maximum Avalanche Energy	E _{AV}	461.9	mJ*
Max. Power Dissipation	P _D	60	W
Operating and Storage Temperature Range	T _{ch}	150	°C
	T _{stg}	-55 ~ +150	°C

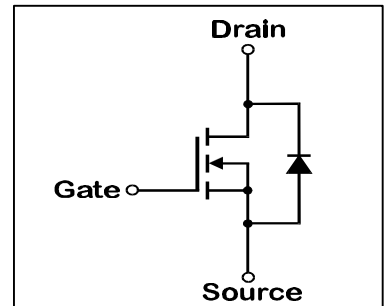

- Electrical Characteristics (T_C=25°C), unless otherwise specified

Item	Symbol	Test conditions	Min.	Typ.	Max.	Unit
Drain-Source Breakdown-Voltage	BV _{DSS}	I _D =1mA V _{GS} =0V	60			V
Gate Threshold Voltage	V _{GS(th)}	I _D =1mA V _{DS} =V _{GS}	1	1,5	2,0	V
Zero Gate Voltage Drain Current	I _{DSS}	V _{DS} =60V T _{ch} =25°C		10	500	μA
		V _{GS} =0V T _{ch} =125°C		0,2	1,0	mA
Gate Source Leakage Current	I _{DSS}	V _{GS} =±20V V _{DS} =0V		10	100	nA
Drain Source On-State Resistance	R _{DS(on)}	ID=22,5A V _{GS} =4V		15	20	
		ID=22,5A V _{GS} =10V		10	12	mΩ
Forward Transconductance	g _{fs}	I _D =22,5A V _{DS} =25V	15	35		S
Input Capacitance	C _{iss}	V _{DS} =25V		2900	4350	pF
Output Capacitance	C _{oss}	V _{GS} =0V		930	1400	pF
Reverse Transfer Capacitance	C _{rss}	f=1MHz		260	390	pF
Turn-On-Time t _{on} (t _{on} =t _{d(on)} +t _r)	t _{d(on)}	V _{CC} =30V		13	30	ns
		V _{GS} =10V		35	50	ns
Turn-Off-Time t _{off} (t _{off} =t _{d(off)} +t _f)	t _{d(off)}	I _D =45A		190	290	ns
		R _{GS} =10 Ω		75	140	ns
Avalanche Capability	I _{AV}	L = 100μH T _{ch} =25°C	45			A
Diode Forward On-Voltage	V _{SD}	I _F =45A V _{GS} =0V T _{ch} =25°C		0,95	1,43	V
Reverse Recovery Time	t _{rr}	I _F =45A V _{GS} =0V		55		ns
Reverse Recovery Charge	Q _{rr}	-di/dt=100A/μs T _{ch} =25°C		0.10		μC

- Thermal Characteristics

Item	Symbol	Min.	Typ.	Max.	Unit
Thermal Resistance	R _{th(ch-c)}			2,08	°C/W
	R _{th(ch-a)}			75,0	°C/W

N-channel MOS-FET			
60V	0,012Ω	±45A	60W

2SK2895-01

FAP-IIIB Series



> Characteristics

Typical Output Characteristics

$I_D = f(V_{DS})$; 80μs pulse test; $T_C = 25^\circ\text{C}$

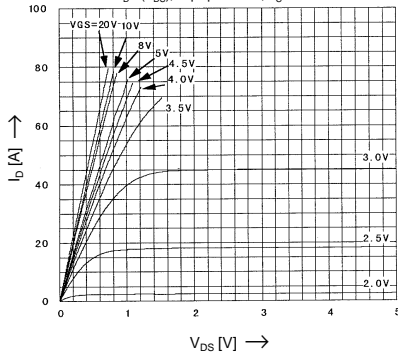

Drain-Source On-State Resistance vs. T_{ch}

$R_{DS(on)} = f(T_{ch})$; $I_D = 22.5\text{A}$; $V_{GS} = 10\text{V}$

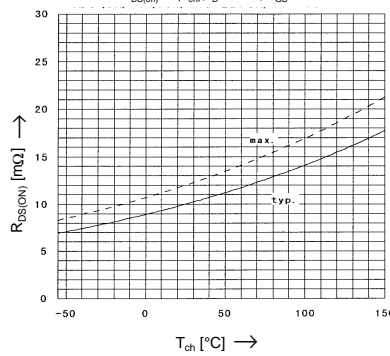

Typical Transfer Characteristics

$I_D = f(V_{GS})$; 80μs pulse test; $V_{DS} = 25\text{V}$; $T_C = 25^\circ\text{C}$

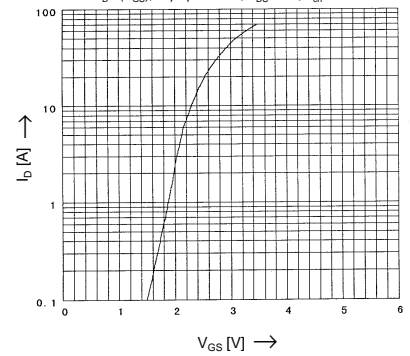

Typical Drain-Source On-State-Resistance vs. I_D

$R_{DS(on)} = f(I_D)$; 80μs pulse test; $T_C = 25^\circ\text{C}$

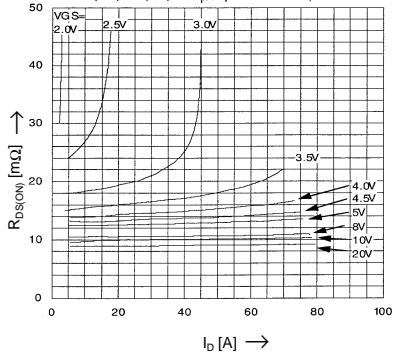

Typical Forward Transconductance vs. I_D

$g_{fs} = f(I_D)$; 80μs pulse test; $V_{DS} = 25\text{V}$; $T_{ch} = 25^\circ\text{C}$

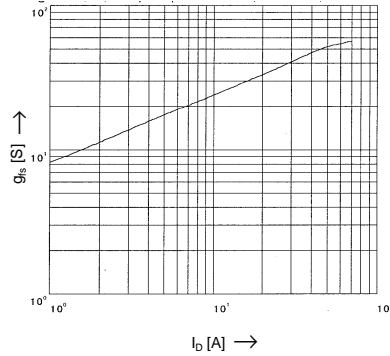

Gate Threshold Voltage vs. T_{ch}

$V_{GS(th)} = f(T_{ch})$; $I_D = 1\text{mA}$; $V_{DS} = V_{GS}$

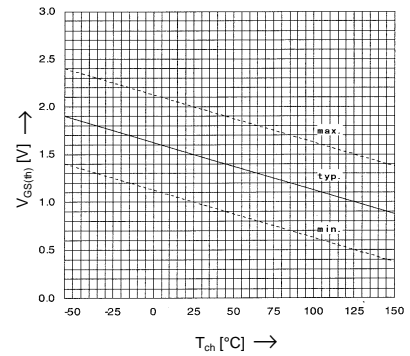

Typical Capacitances vs. V_{DS}

$C = f(V_{DS})$; $V_{GS} = 0\text{V}$; $f = 1\text{MHz}$

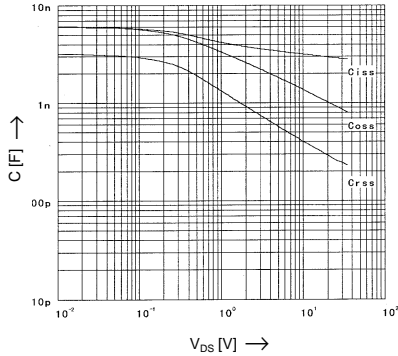

Typical Gate Charge Characteristic

$V_{GS} = f(Q_g)$; $I_D = 45\text{A}$; $T_C = 25^\circ\text{C}$

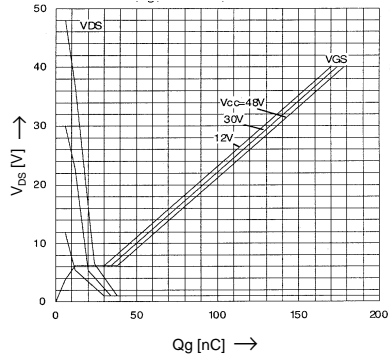

Forward Characteristics of Reverse Diode

$I_F = f(V_{SD})$; 80μs pulse test; $T_{ch} = 25^\circ\text{C}$

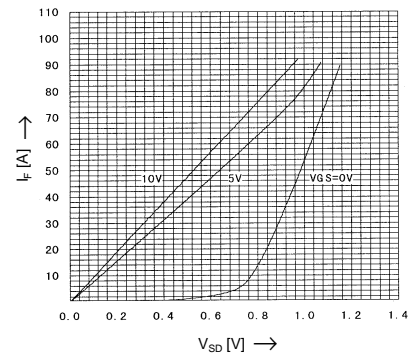

Maximum Avalanche Energy vs. starting T_{ch}

$E_{AS} = f(\text{starting } T_{ch})$; $V_{CC} = 24\text{V}$; $I_{AV} \leq 45\text{A}$

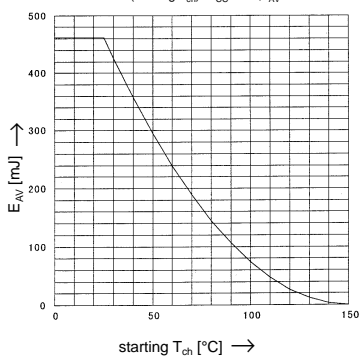

Safe Operation Area

$I_D = f(V_{DS})$; $D = 0.01$; $T_C = 25^\circ\text{C}$

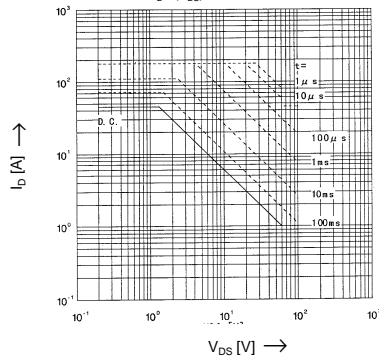

Transient Thermal Impedance

$Z_{th(ch-c)} = f(t)$ parameter: $D \sim t$

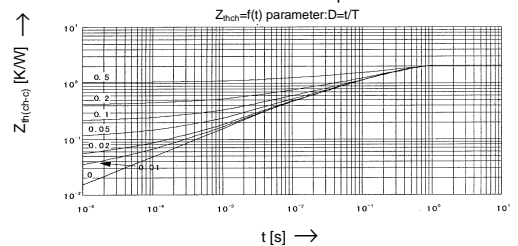

N-channel MOS-FET			
60V	0,012Ω	±45A	60W

2SK2895-01

FAP-IIIB Series



> Characteristics

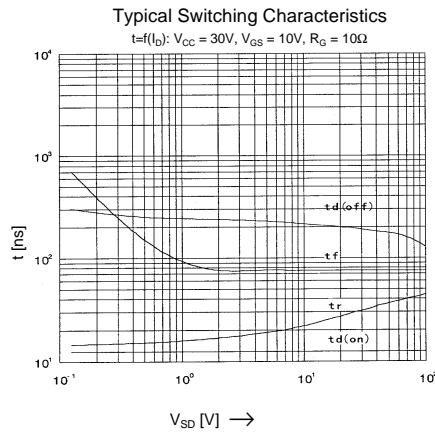

Power Dissipation $P_D=f(T_C)$

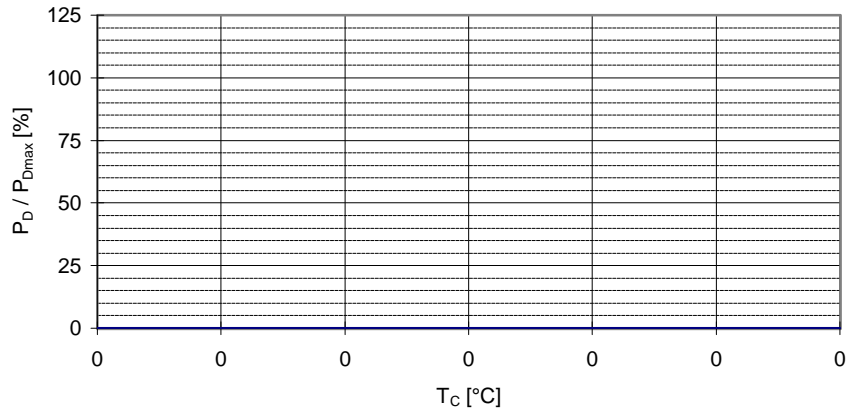

Maximum Avalanche Current vs. starting T_{ch} $I_{AV}=f(\text{starting } T_{ch})$

