

LOW-NOISE DUAL OPERATIONAL AMPLIFIER

■ GENERAL DESCRIPTION

The NJM2041 is a bipolar operational amplifier which is designed as low noise version of the NJM4558 with high output current and fast slew rate ($3V/\mu s$) and wide unity gain bandwidth (7MHz) constructed using New JRC Planar epitaxial process.

■ PACKAGE OUTLINE

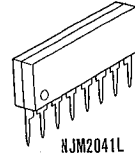
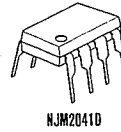

■ FEATURES

- Operating Voltage $(\pm 4V \sim \pm 22V)$
- High Output Current (25mA.)
- Slew Rate ($3V/\mu s$ typ.)
- Unity Gain Bandwidth (7MHz typ.)
- Package Outline DIP8, DMP8, SIP8
- Bipolar Technology

■ PIN CONFIGURATION

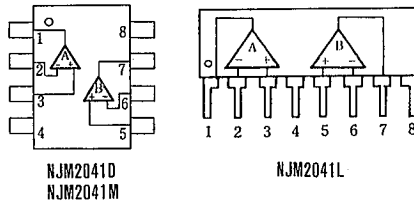

PIN FUNCTION

1. A OUTPUT
2. A-INPUT
3. A+INPUT
4. V^-
5. B+INPUT
6. B-INPUT
7. B OUTPUT
8. V^+

■ EQUIVALENT CIRCUIT (1/2 Shown)

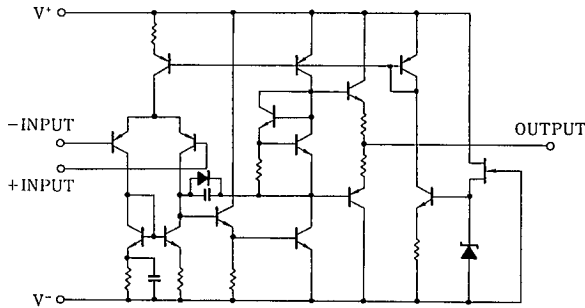

■ ABSOLUTE MAXIMUM RATINGS

(Ta=25°C)

PARAMETER	SYMBOL	RATINGS	UNIT
Supply Voltage	V ⁺ /V ⁻	±22	V
Differential Input Voltage	V _{ID}	±30	V
Input Voltage	V _{IC}	±15 (note)	V
Power Dissipation	P _D	(DIP8) 500	mW
		(DIM8) 300	mW
		(SIP8) 800	mW
Operating Temperature Range	T _{opr}	-20~+75	°C
Storage Temperature Range	T _{stg}	-40~+125	°C

(note) For supply voltage less than ±15V, the absolute maximum input voltage is equal to the supply voltage.

■ ELECTRICAL CHARACTERISTICS

(Ta=25°C, V⁺/V⁻=±15V)

PARAMETER	SYMBOL	TEST CONDITION	MIN.	TYP.	MAX.	UNIT
Input Offset Voltage	V _{IO}	R _S ≤ 10kΩ	—	0.3	3	mV
Input Offset Current	I _{IO}		—	10	200	nA
Input Bias Current	I _B		—	200	500	nA
Input Resistance	R _{IN}		50	200	—	kΩ
Large signal Voltage Gain	A _V	R _L ≥ 2kΩ, V _O = ±10V	86	110	—	dB
Maximum Output Voltage Swing 1	V _{OM1}	R _L ≥ 10kΩ	±12	±14	—	V
Maximum Output Voltage Swing 2	V _{OM2}	I _O = 25mA	±10	±11.5	—	V
Input Common Mode Voltage Range	V _{ICM}		±12	±14	—	V
Common Mode Rejection Ratio	CMR	R _S ≤ 10kΩ	70	100	—	dB
Supply Voltage Rejection Ratio	SVR	R _S ≤ 10kΩ	76	100	—	dB
Operating Current	I _{CC}		—	6	8	mA
Slew Rate	SR		—	3	—	V/μs
Gain Bandwidth Product	GB		—	7	—	MHz
Equivalent Input Noise Voltage	V _{NI}	FLAT+JISA R _S =300Ω	—	0.48	0.61	μVrms

(note) : New JRC's general selected products D-rank are also prepared for the noise standard (R_S=2.2kΩ, RIAA, V_{NI}=1.4μV Max.)

■ TYPICAL CHARACTERISTICS

Large Signal Voltage Gain vs. Frequency

($V^+/V^- = \pm 15V$, $R_L = 2k\Omega$, $T_a = 25^\circ C$)

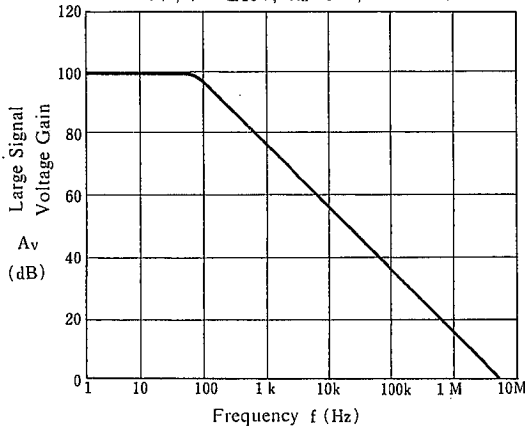

Equivalent Input Noise Voltage

($V^+/V^- = \pm 15V$, $T_a = 25^\circ C$)

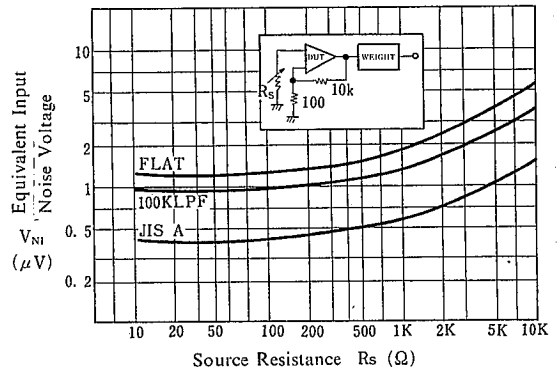

Maximum Output Voltage Swing vs. Load Resistance

($V^+/V^- = \pm 15V$, $T_a = 25^\circ C$)

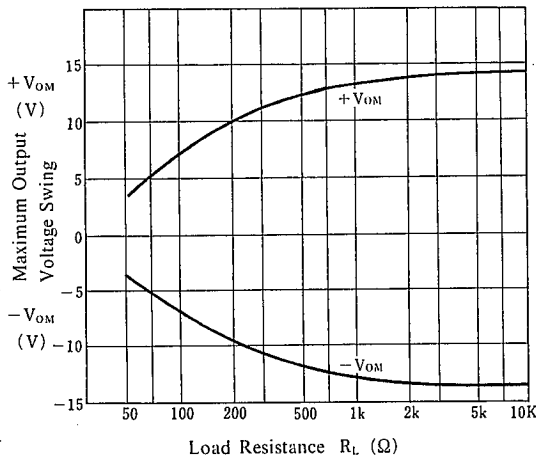

Maximum Output Voltage Swing vs. Output Current

($T_a = 25^\circ C$)

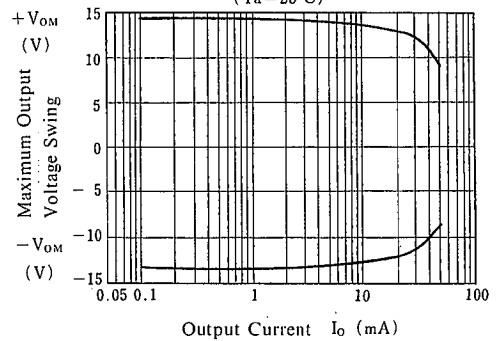

Operating Current vs. Temperature

($V^+/V^- = \pm 15V$)

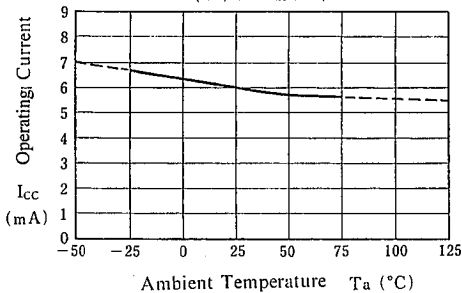

Maximum Output Voltage Swing vs. Temperature

($V^+/V^- = \pm 15V$, $R_L = 10k\Omega$)

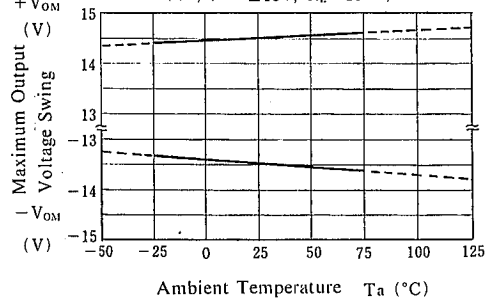

■ TYPICAL CHARACTERISTICS

Input Offset Voltage vs. Temperature

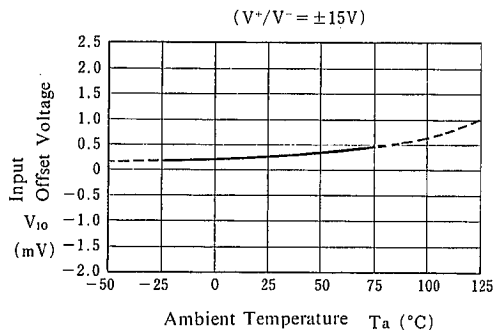

Input Bias Current vs. Temperature

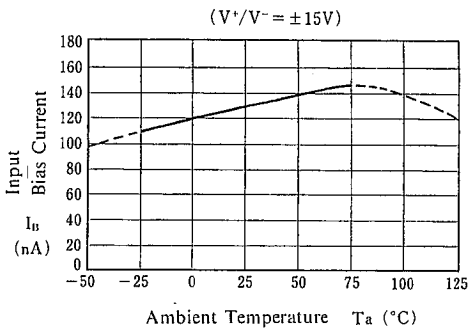

Maximum Output Voltage Swing vs. Operating Voltage

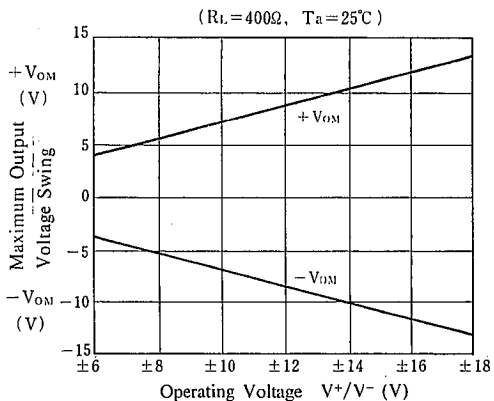

Maximum Output Voltage Swing vs. Operating Voltage

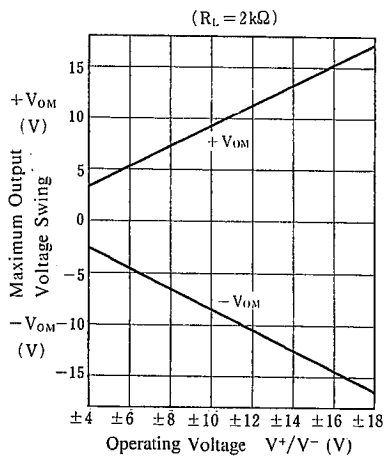

Operating Current vs. Operating Voltage

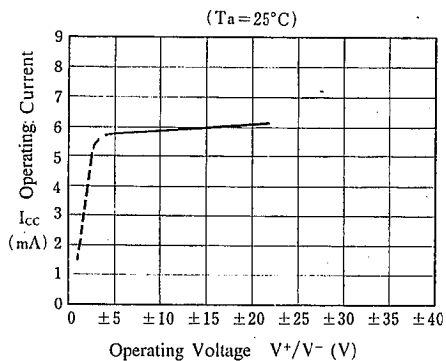

Maximum Output Voltage Swing vs. Frequency

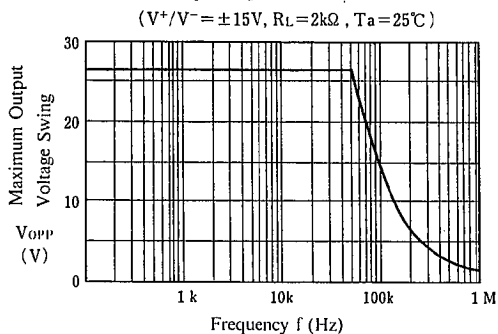

MEMO

[CAUTION]

The specifications on this databook are only given for information, without any guarantee as regards either mistakes or omissions. The application circuits in this databook are described only to show representative usages of the product and not intended for the guarantee or permission of any right including the industrial rights.