

## DUAL J-FET INPUT OPERATIONAL AMPLIFIER

### ■ GENERAL DESCRIPTION

The NJM2082 is JFET input dual operational amplifiers. The NJM2082 features low input offset and bias current, high input impedance. The NJM2082 ideally suits for fast integrator, DA converter, sample & hold and audio applications. The NJM2082 is improved version of the NJM082.

### ■ FEATURES

- Operating Voltage ( $\pm 4V \sim \pm 18V$ )
- High Input Resistance ( $10^{12}\Omega$  typ.)
- High Slew Rate ( $20V/\mu s$  typ.)
- Package Outline DIP8, DMP8, SIP8, (SSOP8)
- Bipolar Technology

### ■ PACKAGE OUTLINE

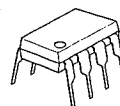

NJM2082D



NJM2082M



NJM2082V

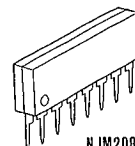

NJM2082L

### ■ PIN CONFIGURATION

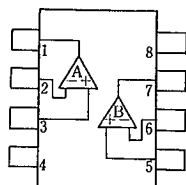

NJM2082D  
NJM2082M  
NJM2082V

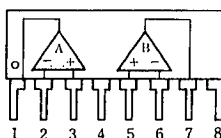

NJM2082L

#### PIN FUNCTION

1. A OUTPUT
2. A-INPUT
3. A+INPUT
4. V-
5. B+INPUT
6. B-INPUT
7. B OUTPUT
8. V+

### ■ EQUIVALENT CIRCUIT (1/2 Shown)

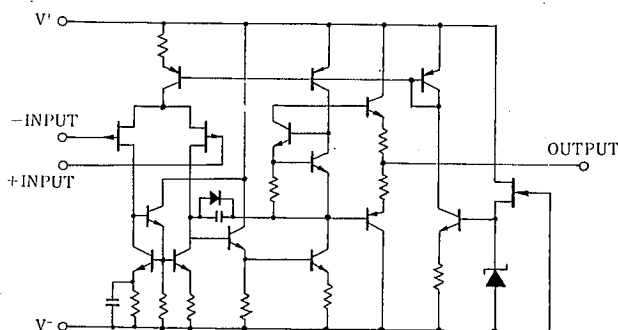

■ ABSOLUTE MAXIMUM RATINGS

(Ta=25°C)

PARAMETER	SYMBOL	RATINGS	UNIT
Supply Voltage	V <sup>+</sup> /V <sup>-</sup>	±18	V
Differential Input Voltage	V <sub>ID</sub>	±30	V
Input Voltage	V <sub>IC</sub>	±15 (note)	V
Power Dissipation	P <sub>D</sub>	(DIP8) 500	mW
		(DIM8) 300	mW
		(SIP8) 800	mW
		(SSOP8) 250	mW
Operating Temperature Range	T <sub>opr</sub>	-40~+85	°C
Storage Temperature Range	T <sub>stg</sub>	-40~+125	°C

(note) For supply voltage less than ±15V, the absolute maximum input voltage is equal to the supply voltage.

■ ELECTRICAL CHARACTERISTICS

(Ta = +25°C, V<sup>+</sup>/V<sup>-</sup> = ±15V)

PARAMETER	SYMBOL	TEST CONDITION	MIN.	TYP.	MAX.	UNIT
Input Offset Voltage	V <sub>IO</sub>	R <sub>S</sub> = 50Ω	—	2	10	mV
Input Offset Current	I <sub>IO</sub>		—	5	200	pA
Input Bias Current	I <sub>B</sub>		—	30	400	pA
Input Resistance	R <sub>IN</sub>		—	10 <sup>12</sup>	—	Ω
Large Signal Voltage Gain	A <sub>V</sub>	R <sub>L</sub> ≥ 2kΩ, V <sub>O</sub> = ±10V	86	110	—	dB
Maximum Output Voltage Swing	V <sub>OM</sub>	R <sub>L</sub> = 2kΩ	±12	+13.5, -13.0	—	V
Input Common Mode Voltage Range	V <sub>ICM</sub>		±12	+15.0, -12.5	—	V
Common Mode Rejection Ratio	CMR	R <sub>S</sub> ≤ 10kΩ	70	90	—	dB
Supply Voltage Rejection Ratio	SVR	R <sub>S</sub> ≤ 10kΩ	76	100	—	dB
Operating Current	I <sub>CC</sub>		—	4	6	mA
Slew Rate	SR		—	20	—	V/μs
Gain Bandwidth Product	GB	f = 10kHz	—	5	—	MHz
Equivalent Input Noise Voltage 1	e <sub>n</sub>	R <sub>S</sub> = 100Ω, f = 1kHz	—	13	—	nV/√Hz
Equivalent Input Noise Voltage 2	V <sub>NI</sub>	RIAA R <sub>S</sub> = 2.2kΩ, 30kHz LPF	—	1.6	—	μVrms

## TYPICAL CHARACTERISTICS

### Voltage Gain vs. Frequency

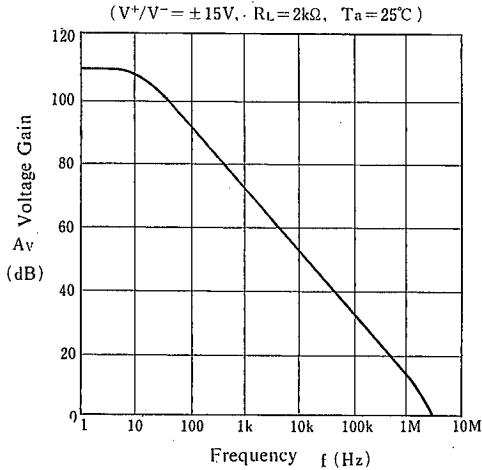

### Maximum Output Voltage Swing vs. Load Resistance

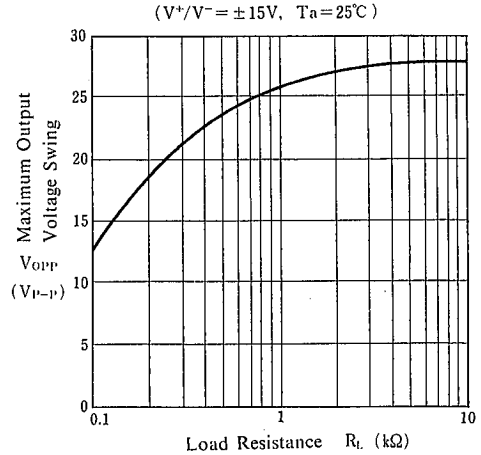

### Maximum Output Voltage Swing vs. Frequency

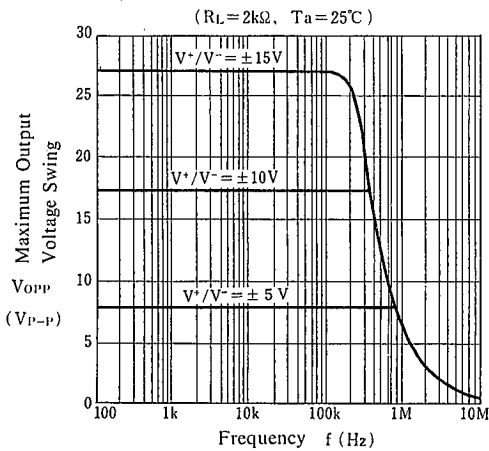

### Equivalent Input Noise Voltage vs. Frequency

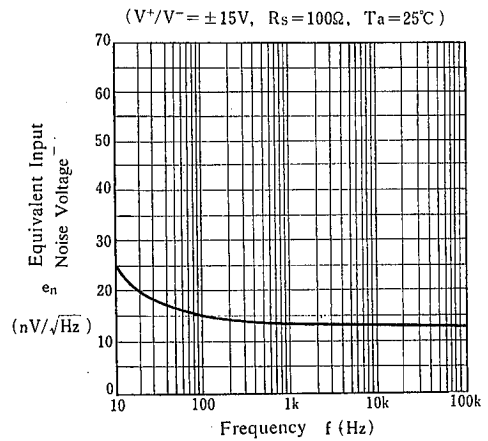

### Equivalent Input Noise Voltage vs. Source Resistance

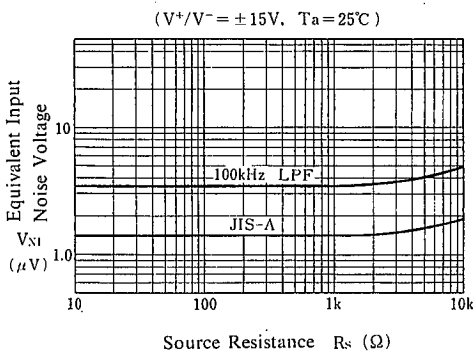

### Voltage Follower Pulse Response

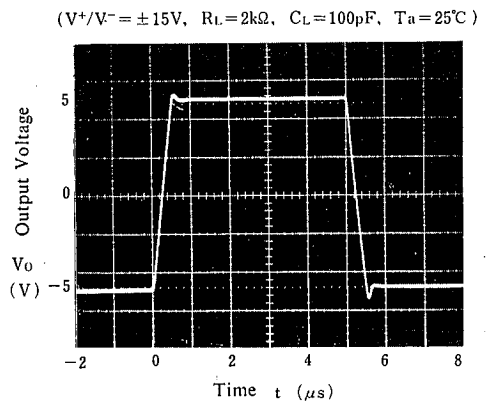

■ TYPICAL CHARACTERISTICS

Operating Current vs. Temperature

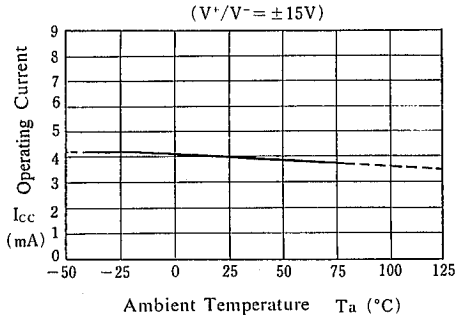

Maximum Output Voltage Swing vs. Temperature

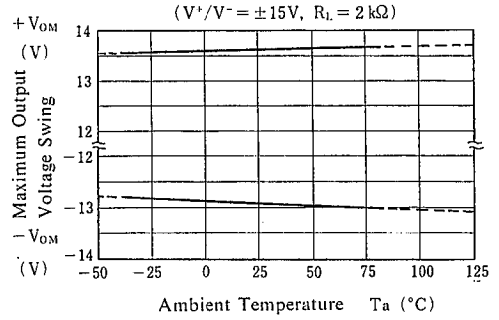

Input Offset Voltage vs. Temperature

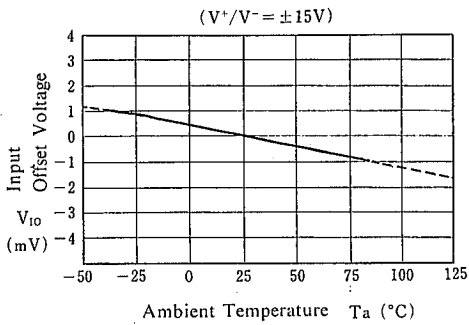

Input Bias Current vs. Temperature

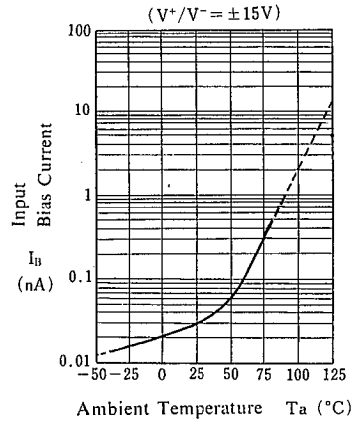

Operating Current vs. Operating Voltage

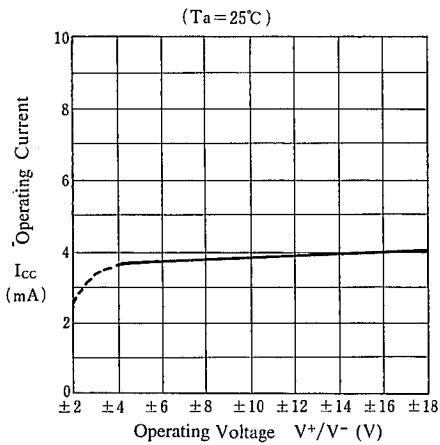

Maximum Output Voltage Swing vs. Operating Voltage

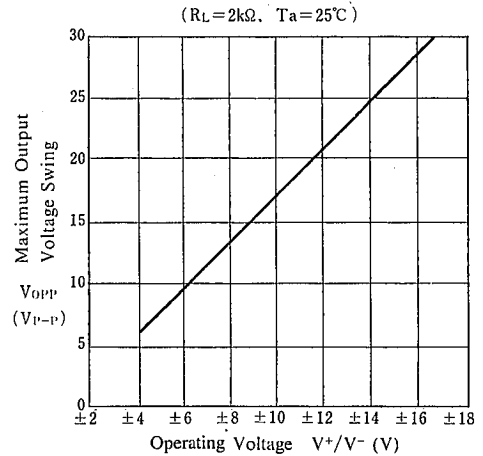

## MEMO

[CAUTION]

The specifications on this databook are only given for information, without any guarantee as regards either mistakes or omissions. The application circuits in this databook are described only to show representative usages of the product and not intended for the guarantee or permission of any right including the industrial rights.