

HIGH PERFORMANCE LOW-NOISE DUAL OPERATIONAL AMPLIFIER

■ GENERAL DESCRIPTION

The NJM5532 is a high performance dual low noise operational amplifier. Compared to the standard dual operational amplifiers, such as the NJM1458, it shows better noise performance, improved output drive capability, and considerably higher small-signal and power bandwidths.

This makes the device especially suitable for application in high quality and professional audio equipment, instrumentation, control circuits, and telephone channel amplifiers. The op amp is internally compensated for gains equal to one. If very low noise is of prime importance, version be used which has guaranteed NJM5532DD it is recommended that the noise specifications.

■ PACKAGE OUTLINE

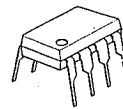

NJM5532D



NJM5532M

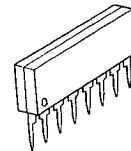

NJM5532L

■ FEATURES

- Operating Voltage (±3V ~ ±20V)
- Small Signal Bandwidth (10MHz typ.)
- Output Drive Capability (600Ω, 10Vrms typ.)
- Input Noise Voltage (5nV/√Hz typ.)
- Power Bandwidth (140kHz typ.)
- Slew Rate (8V/μs typ.)
- Package Outline DIP8, DMP8, SIP8
- Bipolar Technology

■ PIN CONFIGURATION

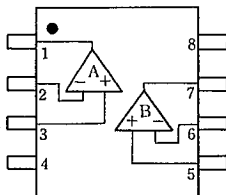

NJM5532D
NJM5532M

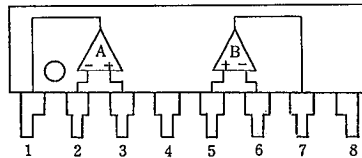

NJM5532L

PIN FUNCTION

1. A OUTPUT
2. A-INPUT
3. A+INPUT
4. V-
5. B+INPUT
6. B-INPUT
7. B OUTPUT
8. V+

■ EQUIVALENT CIRCUIT

(1/2 Shown)

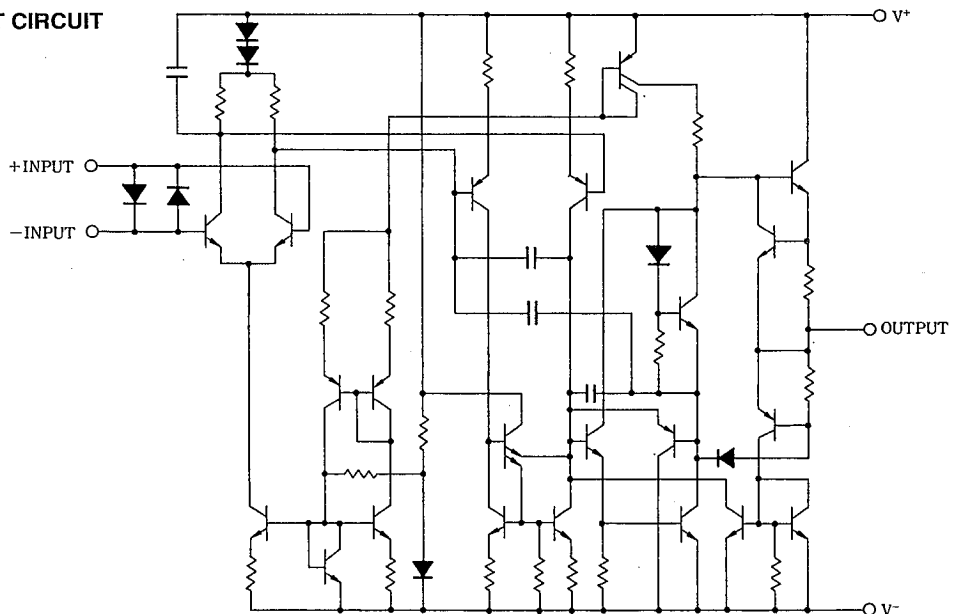

■ ABSOLUTE MAXIMUM RATINGS

(Ta=25°C)

PARAMETER	SYMBOL	RATINGS	UNIT
Supply Voltage	V ⁺ /V ⁻	±22	V
Input Voltage	V _{ic}	V ⁺ /V ⁻	(V)
Differential Input Voltage	V _{id}	±0.5	V
Power Dissipation	P _d	(DIP8) 500	mW
		(DMP8) 600(note)	mW
		(SIP8) 800	mW
Operating Temperature Range	T _{opr}	-20~+75	°C
Storage Temperature Range	T _{slg}	-40~+125	°C

(note) At on a ceramic PCB (10×20×0.635mm)

■ ELECTRICAL CHARACTERISTICS
DC ELECTRICAL CHARACTERISTICS

(V⁺/V⁻=±15V, Ta=25°C)

PARAMETER	SYMBOL	TEST CONDITION	5532			UNIT
			MIN.	TYP.	MAX.	
Input Offset Voltage	V _{IO}	R _L ≥2kΩ, V _O =±10V R _L ≥600Ω, V _O =±10V R _L ≥600Ω R _L ≥600Ω, V ⁺ /V ⁻ =±18V	—	0.5	4	mV
Input Offset Current	I _{IO}		—	10	150	nA
Input Bias Current	I _B		—	200	800	nA
Operating Current	I _{CC}		—	9	16	mA
Input Common Mode Voltage Range	V _{ICM}		±12	±13	—	V
Common Mode Rejection Ratio	CMR		70	100	—	dB
Supply Voltage Rejection Ratio	SVR		.80	100	—	dB
Large Signal Voltage Gain 1	A _{V1}		88	100	—	dB
Large Signal Voltage Gain 2	A _{V2}		83.5	94	—	dB
Maximum Output Voltage Swing 1	V _{OM1}		±12	±13	—	V
Maximum Output Voltage Swing 2	V _{OM2}	±15	±16	—	V	
Input Resistance	R _{IN}	30	300	—	kΩ	
Short Circuit Current	I _{OS}	—	38	—	mA	

■ ELECTRICAL CHARACTERISTICS
AC ELECTRICAL CHARACTERISTICS

(V⁺/V⁻=±15V, Ta=25°C)

PARAMETER	SYMBOL	TEST CONDITION	MIN.	TYP.	MAX.	UNIT
Output Resistance	R _O	A _V =30dB, f=10kHz, R _L =600Ω	—	0.3	—	Ω
Overshoot		A _V =1, V _{IN} =100mV _{p-p} , C _L =100pF, R _L =600Ω	—	10	—	%
Gain	A _V	f=10kHz	—	67	—	dB
Slew Rate	SR		—	8	—	V/μS
Gain Bandwidth Product	GB	C _L 100pF, R _L =600Ω	—	10	—	MHz
Power Bandwidth	W _{PG}	V _O =±10V	—	140	—	kHz
Power Bandwidth	W _{PG}	V _O =±14V, R _L =600Ω, V ⁺ /V ⁻ =±18V	—	100	—	kHz
Equivalent Input Noise Voltage 1	e _{n1}	f _O =30Hz	—	8	—	nV/√Hz
Equivalent Input Noise Voltage 2	e _{n2}	f _O =1kHz	—	5	—	nV/√Hz
Equivalent Input Noise Current 1	i _{n1}	f _O =30Hz	—	2.7	—	pA/√Hz
Equivalent Input Noise Current 2	i _{n2}	f _O =1kHz	—	0.7	—	pA/√Hz
Channel Separation	CS	f=1kHz, R _S =5kΩ	—	110	—	dB

JRC's general selected products D rank are also prepared for the noise standard (R_S=2.2kΩ, R_{1AA}, V_N=1.4μV Max.)

■ Typical Characteristics

Voltage Gain, Phase vs. Frequency
($T_a = 25^\circ\text{C}$)

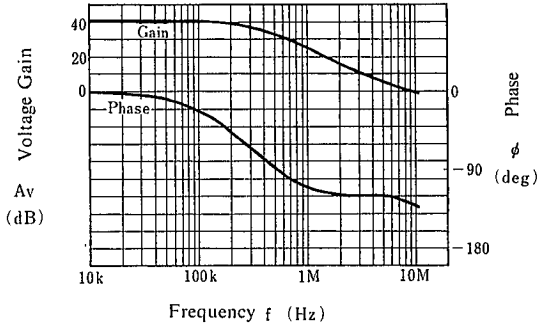

Maximum Output Voltage Swing vs. Load Resistance

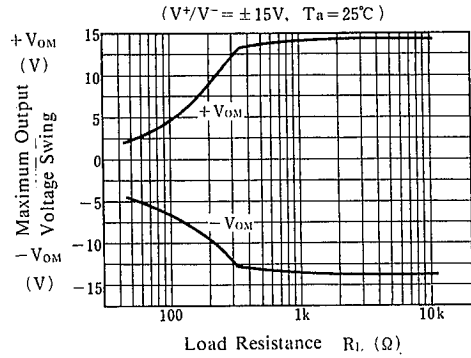

Maximum Output Voltage Swing vs. Frequency

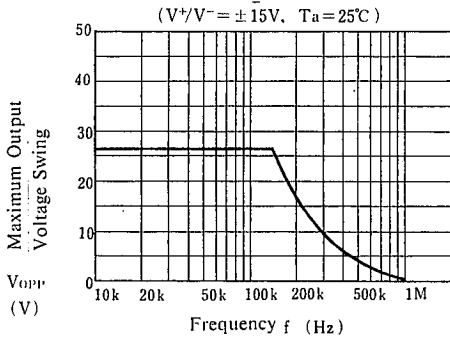

Equivalent Input Noise Voltage vs. Rs

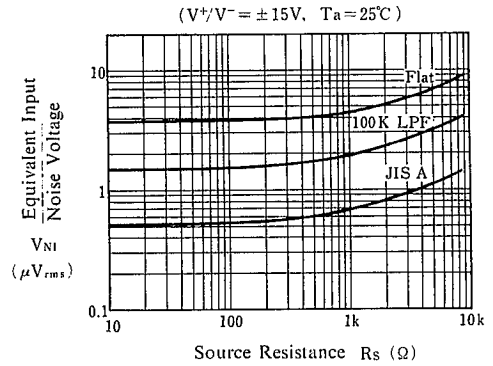

Equivalent Input Noise Voltage vs. Frequency

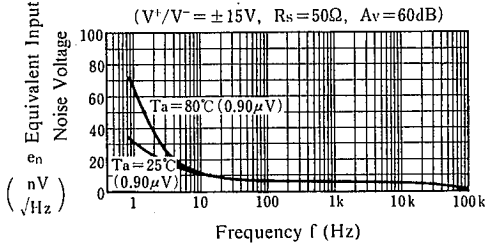

■ TYPICAL CHARACTERISTICS

Operating Current vs. Temperature
($V^+/V^- = \pm 15V$)

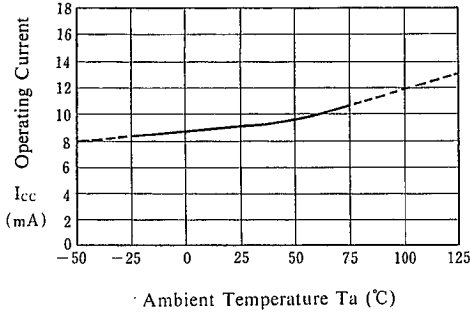

Maximum Output Voltage Swing vs. Temperature
($V^+/V^- = \pm 15V, R_L = 600\Omega$)

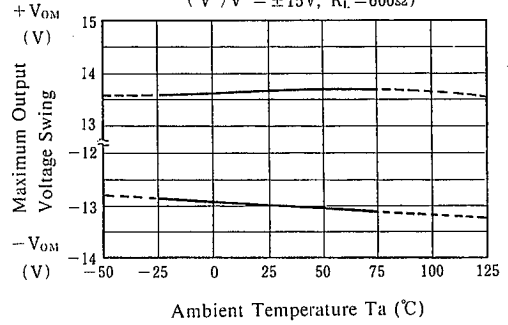

Input Offset Voltage vs. Temperature
($V^+/V^- = \pm 15V$)

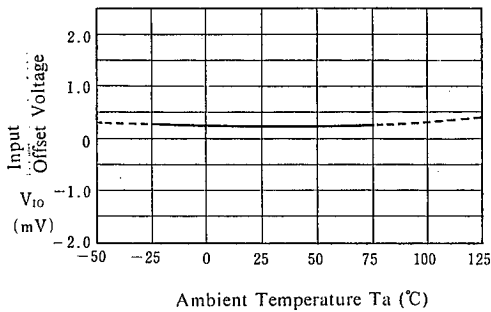

Input Bias Current vs. Temperature
($V^+/V^- = \pm 15V$)

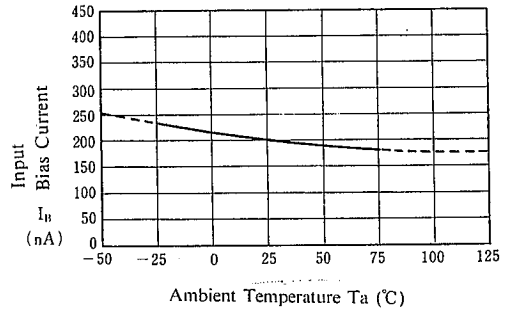

Operating Current vs. Operating Voltage
($T_a = 25^\circ C$)

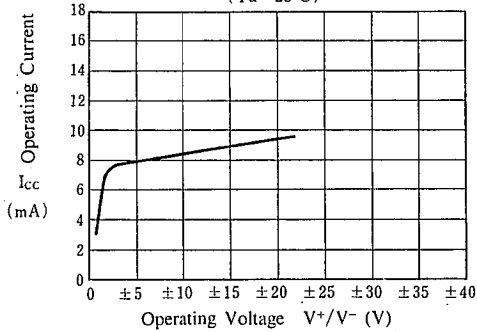

Maximum Output Voltage Swing vs. Operating Voltage
($R_L = 600\Omega, T_a = 25^\circ C$)

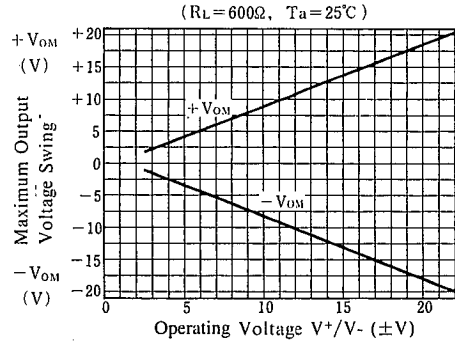

■ TYPICAL CHARACTERISTICS

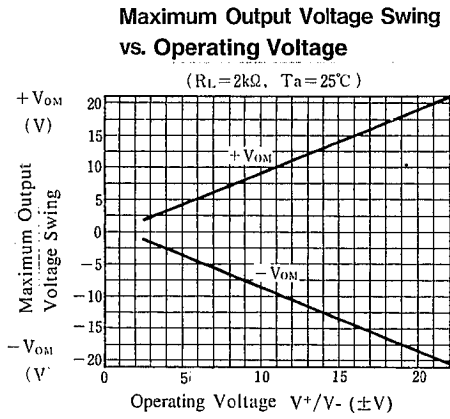

Total Harmonic Distortion vs. Output Voltage

(V⁺/V⁻ = ±15V, R_L = 10kΩ, Gain = 20dB, T_a = 25°C)

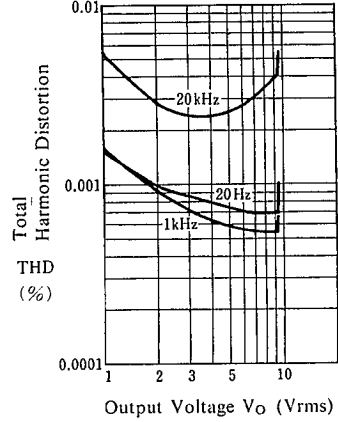

■ NOTICE

When used in voltage follower circuit, put a current limit resistor into non-inverting input terminal in order to avoid inside input diode destruction when the power supply is turned on. (ref. Fig. 1)

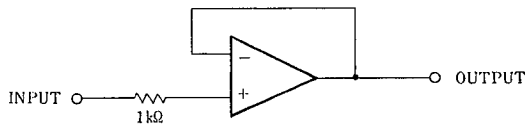

Fig. 1

MEMO

[CAUTION]

The specifications on this databook are only given for information, without any guarantee as regards either mistakes or omissions. The application circuits in this databook are described only to show representative usages of the product and not intended for the guarantee or permission of any right including the industrial rights.