

## LOW VOLTAGE C-MOS OPERATIONAL AMPLIFIER

### ■ GENERAL DESCRIPTION

The NJU7021, 22 and 24 are single, dual and quad C-MOS Operational Amplifiers operated on a single-power-supply, low voltage and low operating current.

The minimum operating voltage is 3V and the output stage permits output signals to swing between both of the supply rails.

The input bias current is as low as less than 1pA, consequently the very small signal around the ground level can be amplified.

Furthermore, the operating current is also as low as 150  $\mu$ A(typ) per circuit, therefore it can be applied especially to battery operated items.

### ■ FEATURES

- Single-Power-Supply
- Wide Operating Voltage ( $V_{DD}=3\sim 16V$ )
- Wide Output Swing Range ( $V_{OM}=9.98V$  typ. at  $V_{DD}=10V$ )
- Low Operating Current (150  $\mu$ A/circuit)
- Low Bias Current ( $I_B=1pA$ )
- Internal Compensation Capacitor
- External Offset Null Adjustment (Only NJU7021)
- Package Outline
  - DIP/DMP/SSOP 8 (NJU7021)
  - DIP/DMP 8 (NJU7022)
  - DIP/DMP/SSOP 14 (NJU7024)
- C-MOS Technology

### ■ PIN CONFIGURATION

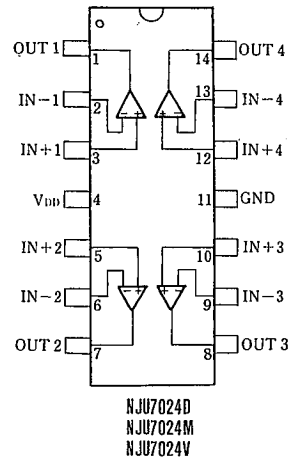
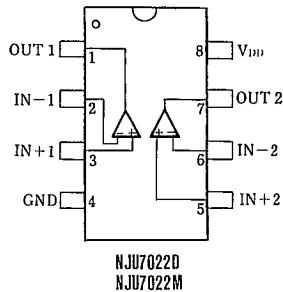
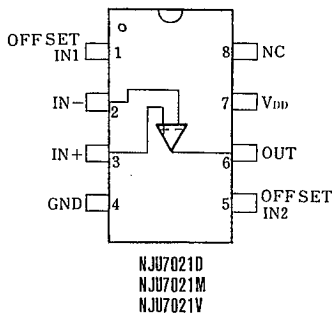

### ■ PACKAGE OUTLINE

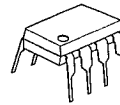

NJU7021D  
NJU7022D



NJU7021M  
NJU7022M

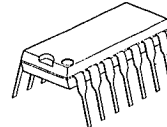

NJU7024D

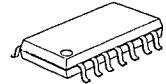

NJU7024M



NJU7021V



NJU7024V

## ■ EQUIVALENT CIRCUIT

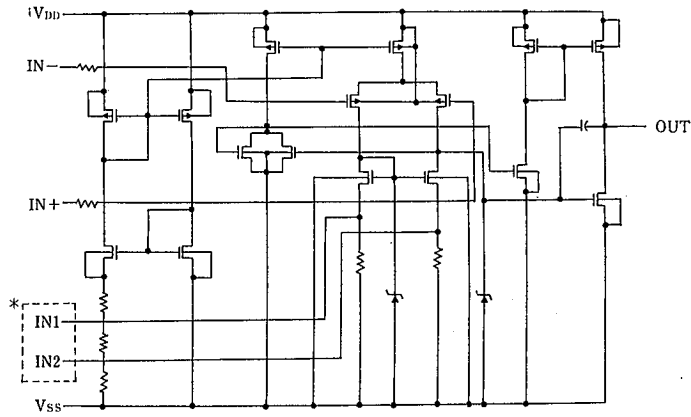

\*  $IN1$ ,  $IN2$  are only for NJU7021 (NJU7022/24 don't have these terminals).

■ ABSOLUTE MAXIMUM RATINGS

(Ta=25°C)

PARAMETER	SYMBOL	RATINGS	UNIT
Supply Voltage	V <sub>DD</sub>	18	V
Differential Input Voltage	V <sub>ID</sub>	±18 *1	V
Common Mode Input Voltage	V <sub>IC</sub>	-0.3~18	V
Power Dissipation	P <sub>D</sub>	(DIP14) 700 (DIP8) 500 (DMP8,14) 300 (SSOP8,14) 300	mW
Operating Temperature	T <sub>opr</sub>	-20~+75	°C
Storage Temperature	T <sub>stg</sub>	-40~+125	°C

\* 1) If the supply voltage (V<sub>DD</sub>) is less than 18V, the input voltage must not over the V<sub>DD</sub> level though 18V is limit specified.

■ ELECTRICAL CHARACTERISTICS

(Ta=25°C, V<sub>DD</sub>=10V, R<sub>L</sub>=∞)

PARAMETER	SYMBOL	CONDITIONS	MIN.	TYP.	MAX.	UNIT
Input Offset Voltage	V <sub>IO</sub>	R <sub>S</sub> =50Ω			10	mV
Input Offset Current	I <sub>IO</sub>			1		pA
Input Bias Current	I <sub>IB</sub>			1		pA
Input Impedance	R <sub>IN</sub>			1		TΩ
Large Signal Voltage Gain	A <sub>v</sub>		80	95		dB
Input Common Mode Voltage Range	V <sub>ICM</sub>		0~9			V
Maximum Output Swing Voltage	V <sub>OM</sub>	R <sub>L</sub> =1MΩ	9.80	9.98		V
Common Mode Rejection Ratio	CMR		60	75		dB
Supply Voltage Rejection Ratio	SVR		60	75		dB
Operating Current / Circuit	I <sub>DD</sub>			150	300	μA
Slew Rate	SR			0.40		V/μs
Unity Gain Bandwidth	F <sub>t</sub>	A <sub>v</sub> =40dB C <sub>L</sub> =10pF		0.4		MHz

■ OFFSET ADJUSTMENT CIRCUIT (ONLY FOR NJU7021)

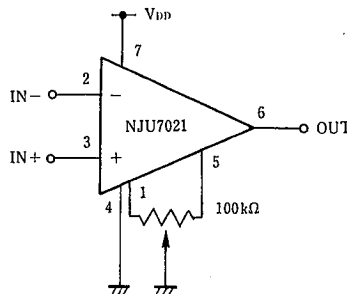

■ TYPICAL CHARACTERISTICS

Operating Current vs. Operating Voltage

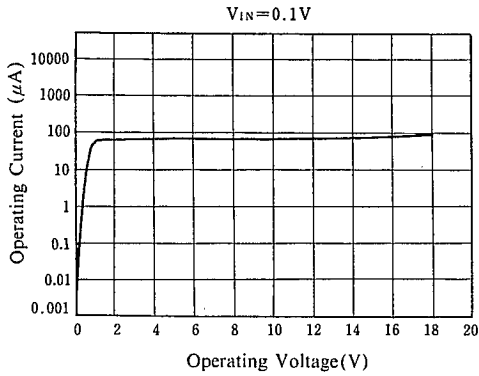

Offset Voltage vs. Operating Voltage

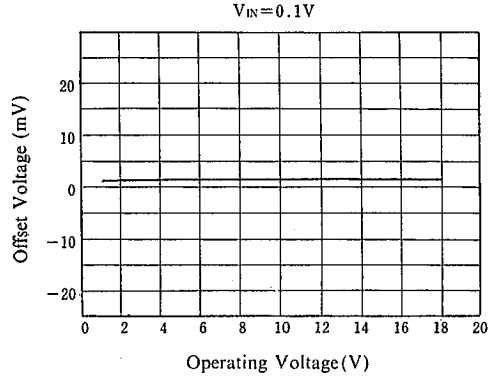

Output Current vs. Operating Voltage

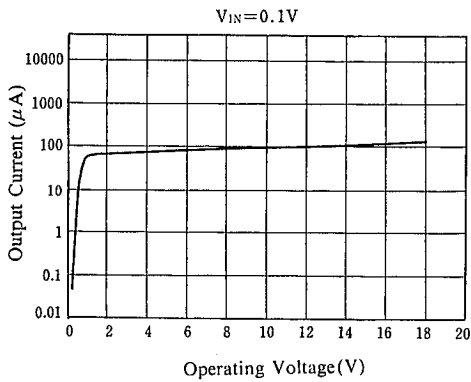

Offset Voltage vs. Input Voltage

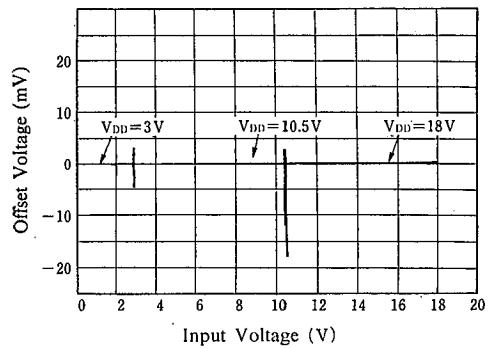

Output Voltage vs. Output Current

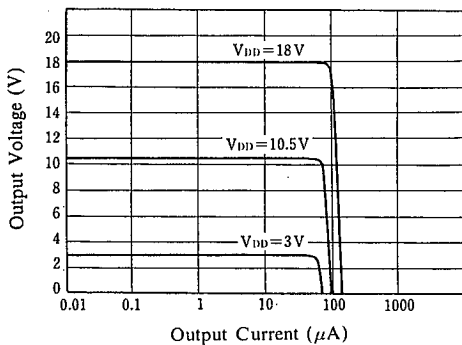

Maximum Output Swing Voltage vs. Frequency

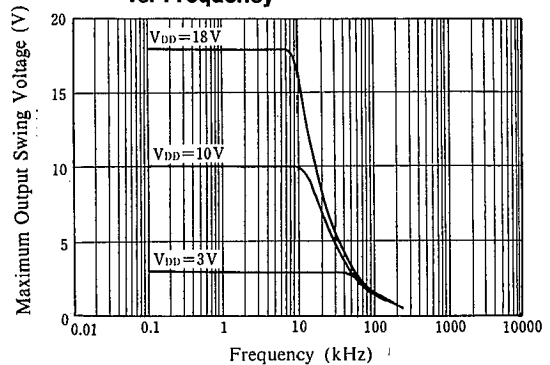

■ TYPICAL CHARACTERISTICS

Maximum Output Swing Voltage vs. Frequency

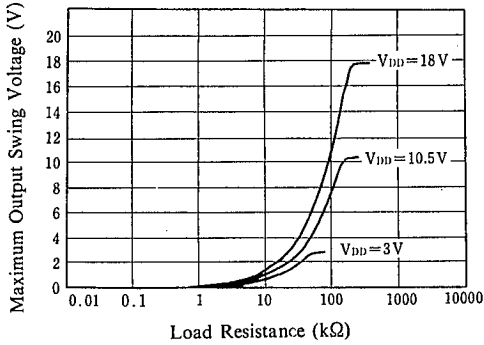

Voltage Gain · Phase vs. Frequency

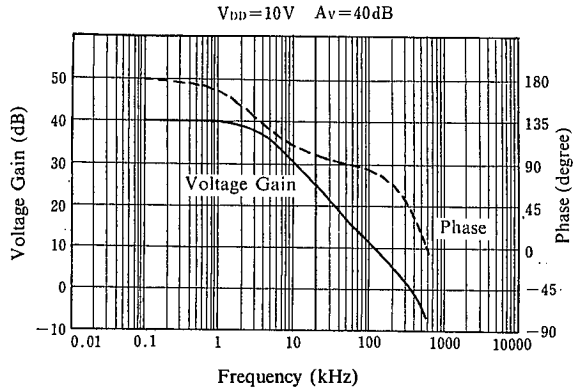

Equivalent Input Noise Voltage vs. Frequency

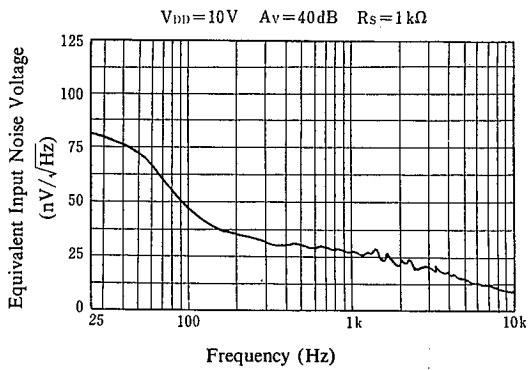

## MEMO

[CAUTION]

The specifications on this databook are only given for information, without any guarantee as regards either mistakes or omissions. The application circuits in this databook are described only to show representative usages of the product and not intended for the guarantee or permission of any right including the industrial rights.