

LOW-POWER AND LOW-OFFSET-VOLTAGE
TINY SINGLE C-MOS OPERATIONAL AMPLIFIER

■ GENERAL DESCRIPTION

The NJU7091A, 92A and 93A are single C-MOS operational amplifiers operated on a single-power-supply, low voltage and low operating current.

The input offset voltage is lower than 2mV, and the input bias current is as low as than 1pA, consequently very small signal around the ground level can be amplified.

The minimum operating voltage is 1V and the output stage permits output signal to swing between both of the supply rails.

Furthermore, this series is packaged with very small MTP-5, therefore it can be especially applied to portable items.

■ PACKAGE OUTLINE



NJU709XAF

■ FEATURES

- Single-Power-Supply
- Low Offset Voltage $V_{i.o}=2\text{mV max}$
- Wide Operating Voltage $V_{D.D}=1\sim 5.5\text{V}$
- Wide Output Swing Range $V_{o.m}=2.9\text{V min @}3.0\text{V}$
- Low Operating Current
- Low Bias Current $I_{i.B}=1\text{pA typ}$
- Compensation Capacitor Incorporated
- Package Outline MTP-5
- C-MOS Technology

■ PIN CONFIGURATION

(Top View)

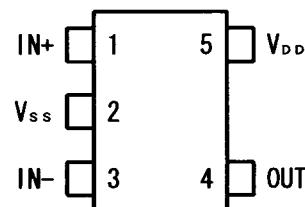

■ LINE-UP

($T_a=25^\circ\text{C}$, $V_{D.D}=3.0\text{V}$)

PARAMETER	NJU7091A	NJU7092A	NJU7093A	UNIT
Operating Current	15	80	200	$\mu\text{A (typ)}$
Slew Rate	0.1	1.0	2.4	$\text{V}/\mu\text{s (typ)}$
Unity Gain Bandwidth	0.2	1.0	1.0	MHz (typ)

■ EQUIVALENT CIRCUIT

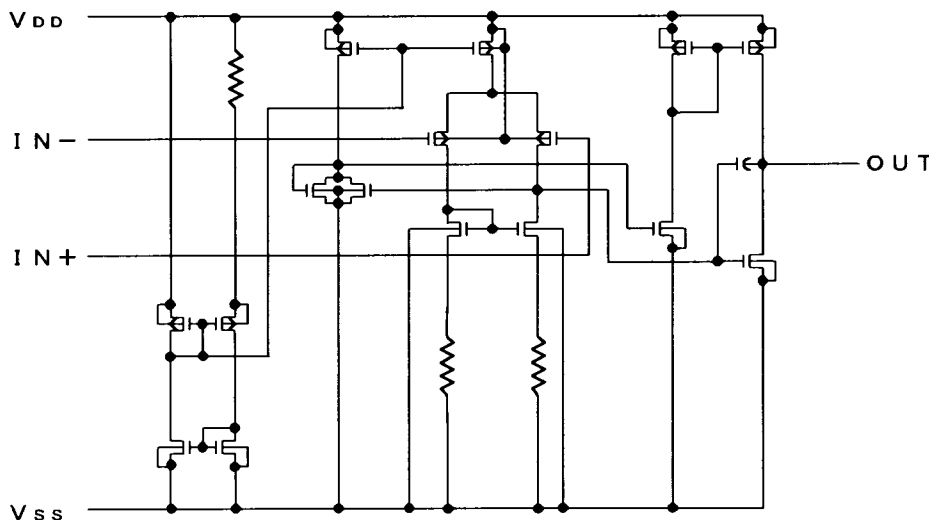

■ ABSOLUTE MAXIMUM RATINGS

(Ta=25°C)

PARAMETER	SYMBOL	RATINGS	UNIT
Supply Voltage	V _{DD}	6.5	V
Differential Input Voltage	V _{ID}	±6.5 Note1	V
Common Mode Input Voltage	V _{IC}	- 0.3 ~ 6.5	V
Power Dissipation	P _D	200	mW
Operating Temperature	T _{opr}	- 40 ~ + 85	°C
Storage Temperature	T _{stg}	- 55 ~ +125	°C

Note1) If the supply voltage (V_{DD}) is less than 6.5V, the input voltage must not over the V_{DD} level though 6.5V is limit specified.

Note2) Decoupling capacitor should be connected between V_{DD} and V_{SS} due to the stabilized operation for the circuit.

■ ELECTRICAL CHARACTERISTICS

NJU7091A

 (Ta=25°C, V_{DD}=3.0V, R_L=∞)

PARAMETER	SYMBOL	CONDITIONS	MIN	TYP	MAX	UNIT
Input Offset Voltage	V _{IO}	V _{IN} =1/2V _{DD}	—	—	2	mV
Input Offset Current	I _{IO}		—	1	—	pA
Input Bias Current	I _{IB}		—	1	—	pA
Input Impedance	R _{IN}		—	1	—	TΩ
Large Signal Voltage Gain	A _{VD}		60	70	—	dB
Input Common Mode Voltage Range	V _{ICM}		0~2.5	—	—	V
Maximum Output Swing Voltage	V _{OM1}	R _L =1MΩ	V _{DD} -0.1	—	—	V
	V _{OM2}	R _L =1MΩ	—	—	V _{SS} +0.1	V
Common Mode Rejection Ratio	CMR	V _{IN} =1/2V _{DD}	55	65	—	dB
Supply Voltage Rejection Ratio	SVR	V _{DD} =1.5~5.5V	60	70	—	dB
Operating Current	I _{DD}		—	15	25	uA
Slew Rate	SR		—	0.1	—	V/us
Unity Gain Bandwidth	F _t	A _v =40dB, C _L =10pF	—	0.2	—	MHz

Note3) The source current is less than 2.9uA (at V_{OM}/R_L=2.9V/1MΩ).

NJU7092A

 (Ta=25°C, V_{DD}=3.0V, R_L=∞)

PARAMETER	SYMBOL	CONDITIONS	MIN	TYP	MAX	UNIT
Input Offset Voltage	V _{IO}	V _{IN} =1/2V _{DD}	—	—	2	mV
Input Offset Current	I _{IO}		—	1	—	pA
Input Bias Current	I _{IB}		—	1	—	pA
Input Impedance	R _{IN}		—	1	—	TΩ
Large Signal Voltage Gain	A _{VD}		60	70	—	dB
Input Common Mode Voltage Range	V _{ICM}		0~2.5	—	—	V
Maximum Output Swing Voltage	V _{OM1}	R _L =100kΩ	V _{DD} -0.1	—	—	V
	V _{OM2}	R _L =100kΩ	—	—	V _{SS} +0.1	V
Common Mode Rejection Ratio	CMR	V _{IN} =1/2V _{DD}	55	65	—	dB
Supply Voltage Rejection Ratio	SVR	V _{DD} =1.5~5.5V	60	70	—	dB
Operating Current	I _{DD}		—	80	160	μA
Slew Rate	SR		—	1.0	—	V/μs
Unity Gain Bandwidth	Ft	A _V =40dB, C _L =10pF	—	1.0	—	MHz

 Note4) The source current is less than 29μA (at V_{OM}/R_L=2.9V/100kΩ).

NJU7093A

 (Ta=25°C, V_{DD}=3.0V, R_L=∞)

PARAMETER	SYMBOL	CONDITIONS	MIN	TYP	MAX	UNIT
Input Offset Voltage	V _{IO}	V _{IN} =1/2V _{DD}	—	—	2	mV
Input Offset Current	I _{IO}		—	1	—	pA
Input Bias Current	I _{IB}		—	1	—	pA
Input Impedance	R _{IN}		—	1	—	TΩ
Large Signal Voltage Gain	A _{VD}		60	70	—	dB
Input Common Mode Voltage Range	V _{ICM}		0~2.5	—	—	V
Maximum Output Swing Voltage	V _{OM1}	R _L =50kΩ	V _{DD} -0.1	—	—	V
	V _{OM2}	R _L =50kΩ	—	—	V _{SS} +0.1	V
Common Mode Rejection Ratio	CMR	V _{IN} =1/2V _{DD}	55	65	—	dB
Supply Voltage Rejection Ratio	SVR	V _{DD} =1.5~5.5V	60	70	—	dB
Operating Current	I _{DD}		—	200	400	μA
Slew Rate	SR		—	1.0	—	V/μs
Unity Gain Bandwidth	Ft	A _V =40dB, C _L =10pF	—	1.0	—	MHz

 Note5) The source current is less than 58μA (at V_{OM}/R_L=2.9V/50kΩ).

■ TYPICAL CHARACTERISTICS

(1) NJU7091A

Output Voltage vs. Output Current (SOURCE)

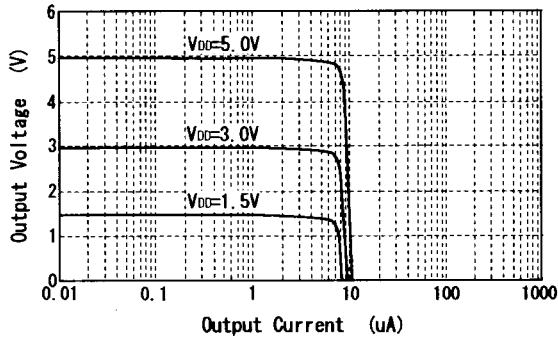

Output Voltage vs. Output Current (SINK)

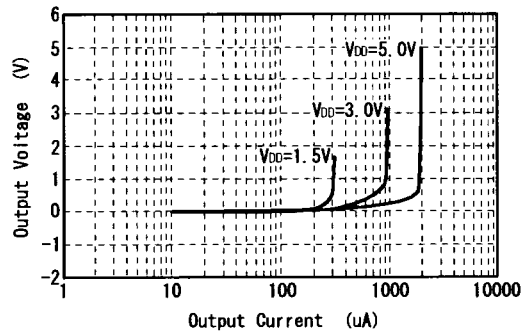

Offset Voltage vs. Operating Voltage

$V_{IN}=0.1V$

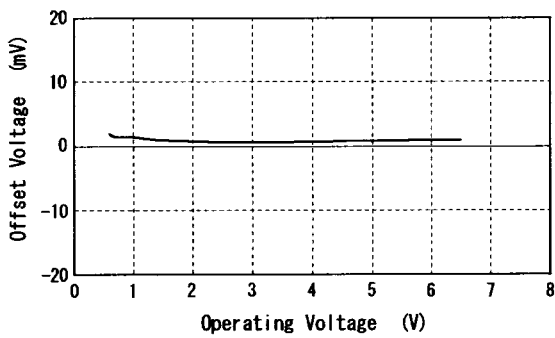

Offset Voltage vs. Input Voltage

$V_{DD}=3.0V$

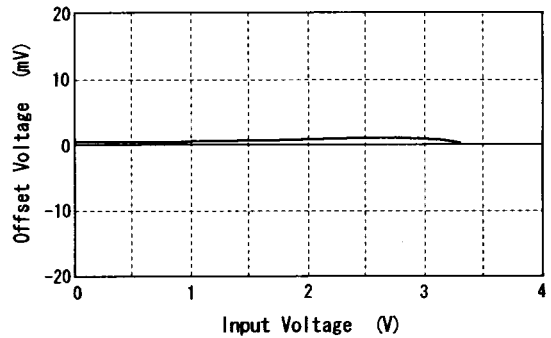

Operating Current vs. Operating Voltage

$V_{IN}=0.1V$

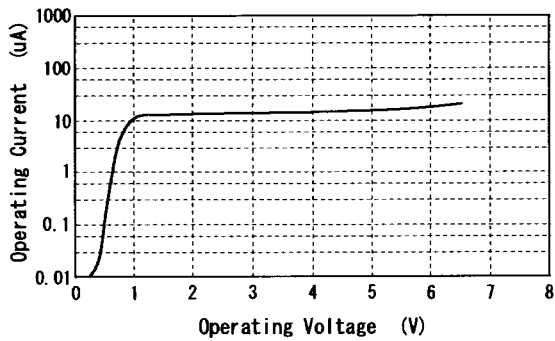

Output Current vs. Operating Voltage

$V_{IN}=0.1V$

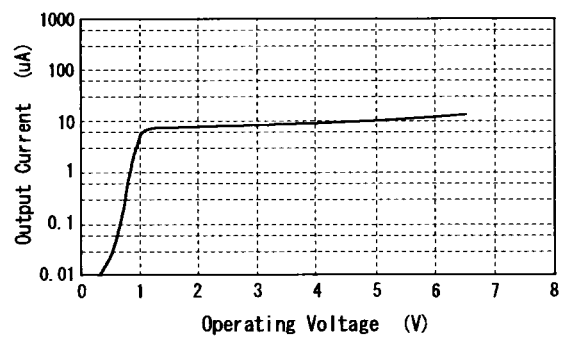

Maximum Output Swing Voltage vs. Load Resistance

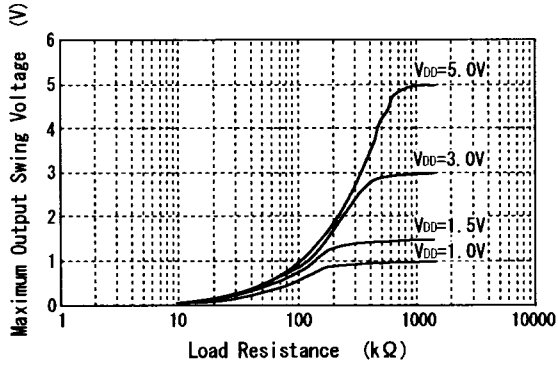

Maximum Output Swing Voltage vs. Frequency

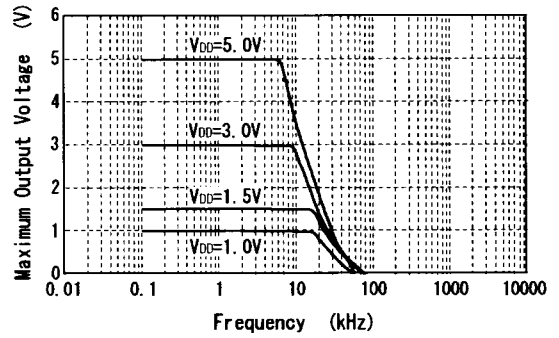

Voltage Gain-Phase vs. Frequency

V_{DD}=3V, R_s=1kΩ, A_v=40dB

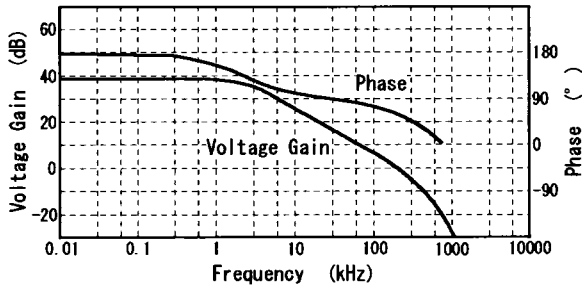

(2) NJU7092A

Output Voltage vs. Output Current (SOURCE)

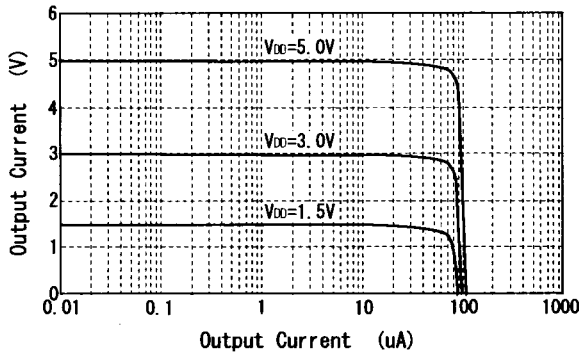

Output Voltage vs. Output Current (SINK)

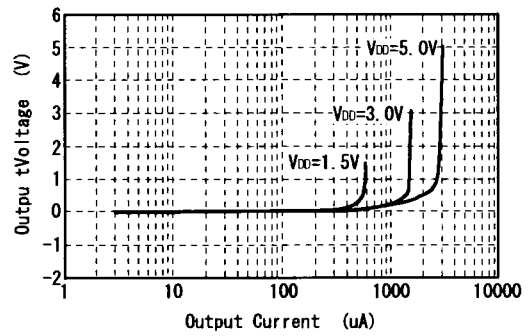

Offset Voltage vs. Operating Voltage

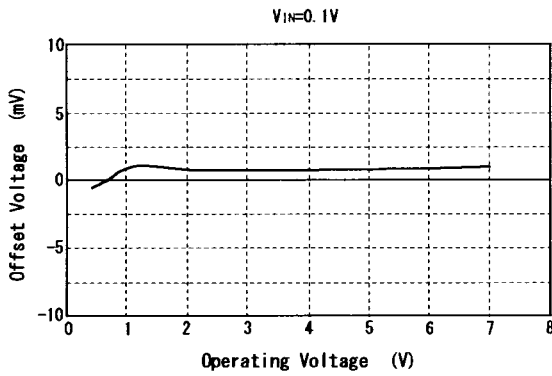

Offset Voltage vs. Input Voltage

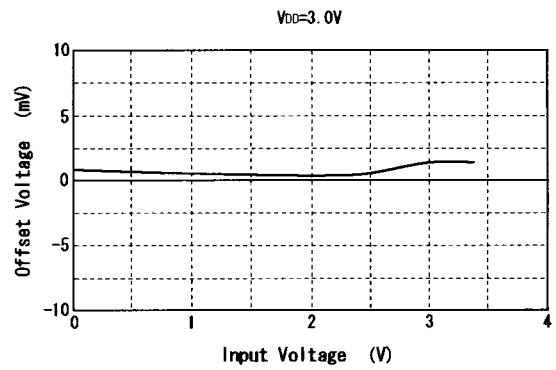

Operating Current vs. Operating Voltage

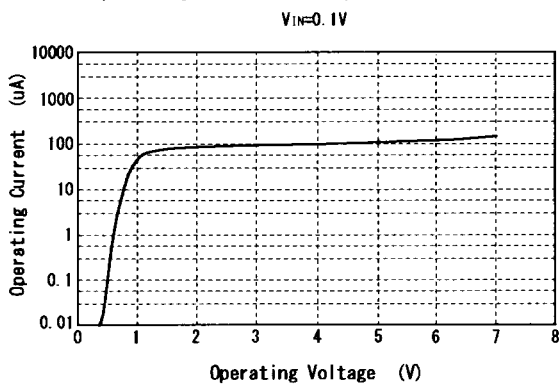

Output Current vs. Operating Voltage

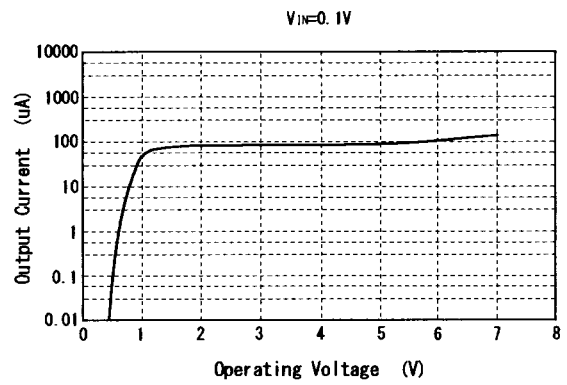

Maximum Output Swing Voltage vs. Load Resistance

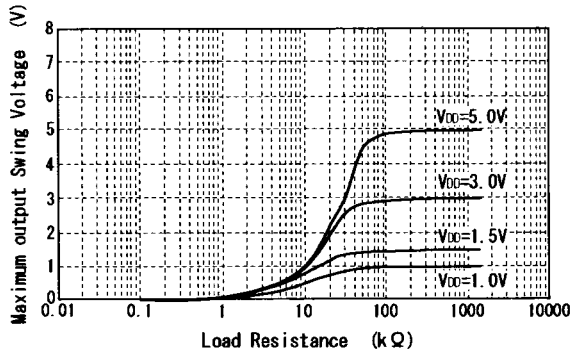

Maximum Output Swing Voltage vs. Frequency

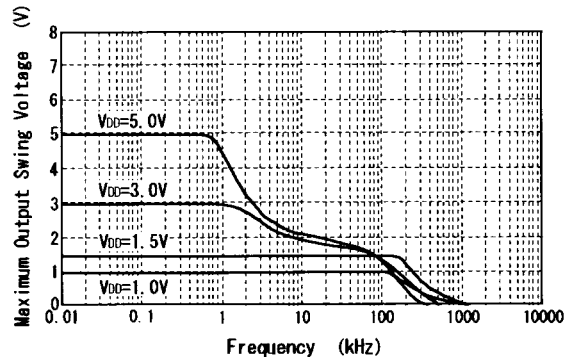

Voltage Gain-Phase vs. Frequency

V_{DD}=3V, R_s=1kΩ, A_v=40dB

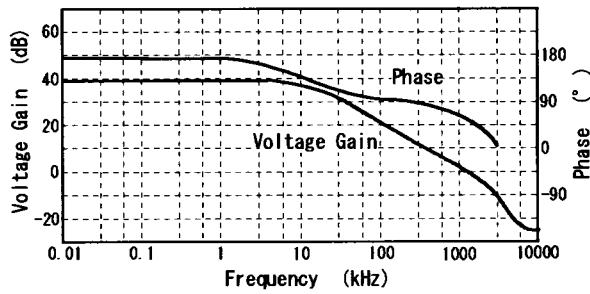

(3) NJU7093A

Output Voltage vs. Output Current (SOURCE)

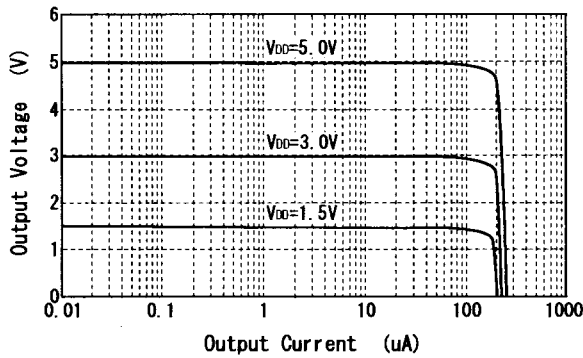

Output Voltage vs. Output Current (SINK)

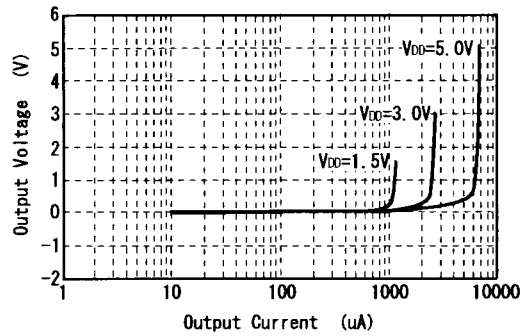

Offset Voltage vs. Operating Voltage

V_{IN}=0.1V

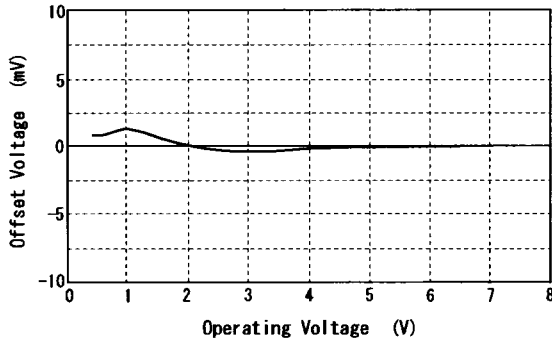

Offset Voltage vs. Input Voltage

V_{DD}=3.0V

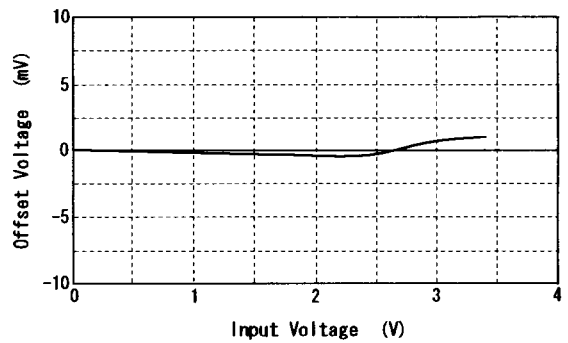

Operating Current vs. Operating Voltage

V_{IN}=0.1V

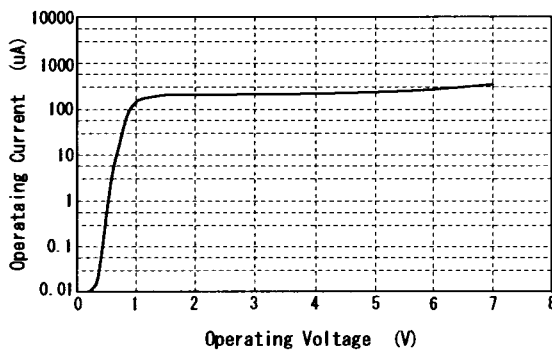

Output Current vs. Operating Voltage

V_{IN}=0.1V

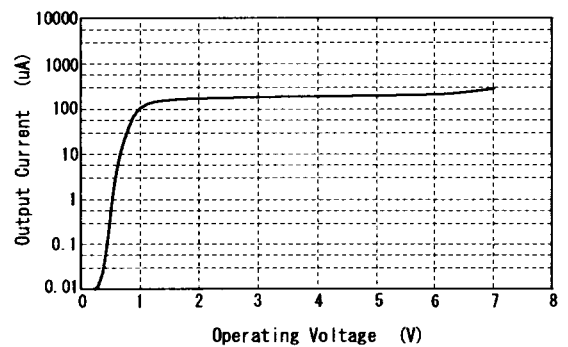

Maximum Output Swing Voltage vs. Load Resistance

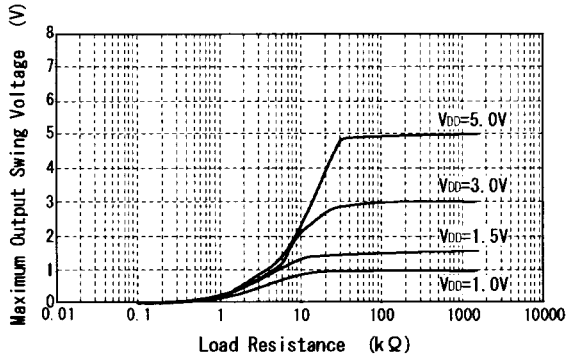

Maximum Output Swing Voltage vs. Frequency

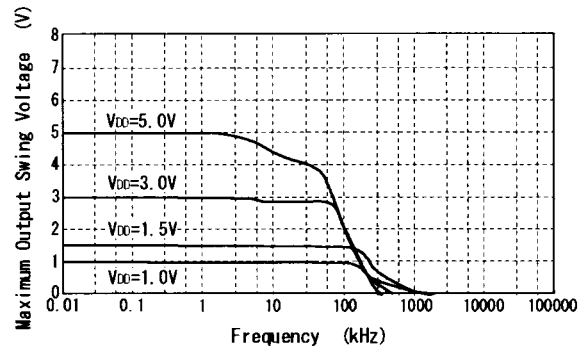

Voltage Gain-Phase vs. Frequency

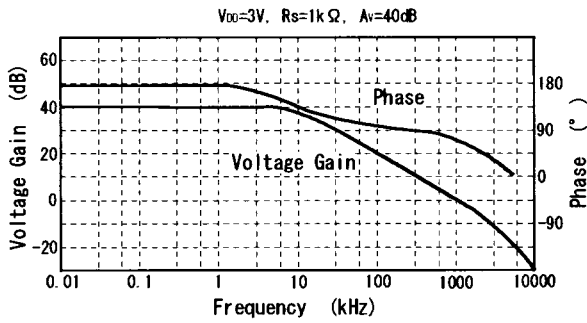

[CAUTION]

The specifications on this data book are only given for information, without any guarantee as regards either mistakes or omissions. The application circuits in this data book are described only to show representative usages of the product and not intended for the guarantee or permission of any right including the industrial rights.