



MIC2660

IttyBitty™ Charge Pump

Not Recommended for New Designs

General Description

The MIC2660 IttyBitty™ charge pump functions as a low-current, step-up converter where conventional inductor based, dc-to-dc converters are too complex and expensive. This device features a complete, self-contained charge pump in a tiny 5-lead SOT-23-5 package.

The MIC2660 is powered from a 3V to 5V nominal supply and produces nominally 5V to 9V as a function of the input voltage. The output is unregulated and follows a load-line type function.

The MIC2660 can be used with or without external components. When used with two noncritical external capacitors, a 3V input will produce 5V at 3.8mA. With no external components, a 3V input will produce 5V at 2.5mA.

The MIC2660 charge pump consists of an approximately 18MHz oscillator and a voltage tripler.

The MIC2660 is available in the SOT-23-5 package and is rated for -40°C to +85°C ambient temperature range.

Features

- 3V input produces approx. 5V unregulated output*
3.8mA with 1μF external output capacitor
2.5mA without external capacitor
- 5V input produces approx. 9V unregulated output*
4.5mA output without external capacitor
- CMOS-logic compatible enable
- ESD protected

Applications

- Squib firing
- Refresh
- Burst/dump
- Low duty cycle load
- LCD bias generator
- Local 5V logic supply
- MOSFET driver
- Battery or solarcell boost

Ordering Information

| Part Number | Temperature Range | Package |
|-------------|-------------------|----------|
| MIC2660BM5 | -40°C to +85°C | SOT-23-5 |

Typical Application

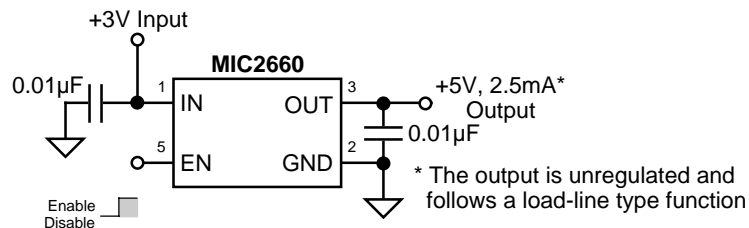

Low-Current Unregulated Step-Up Supply

Timing Diagram

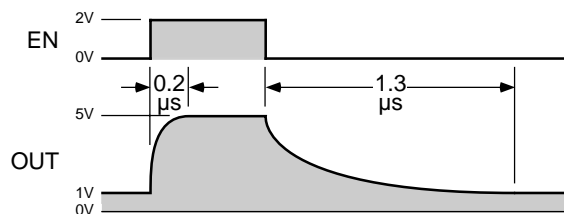

Output vs. Enable Input

Pin Configuration

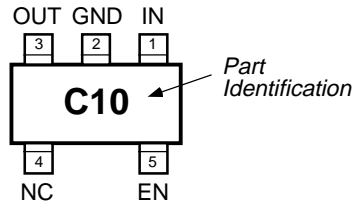

SOT-23-5 (M5)

Pin Description

| Pin Number | Pin Name | Pin Function |
|------------|----------|--|
| 1 | IN | Supply (Input): +3V to +5V supply. |
| 2 | GND | Ground: Power return. |
| 3 | OUT | Output: Charge pump output. Connect to load. |
| 4 | NC | Not internally connected. |
| 5 | EN | Enable (Input): CMOS compatible input. EN high ($V_{EN} = V_{IN}$) enables the charge pump. EN low ($V_{IN} = 0V$) disables the charge pump. |

Absolute Maximum Ratings

Input Voltage (V_{IN}) +5.5V
 Enable Voltage (V_{EN}) $V_{IN} + 1.3V$
 Ambient Temperature Range (T_A) $-40^{\circ}C$ to $+85^{\circ}C$

Lead Temperature, Soldering 10sec. $300^{\circ}C$
 Package Thermal Resistance
 SOT-23-5 θ_{JA} $220^{\circ}C/W$
 SOT-23-5 θ_{JC} $130^{\circ}C/W$

Electrical Characteristics

| Parameter | Condition (Note 1) | Min | Typ | Max | Units |
|--------------------------|---|-----|------|------|---------|
| Output Voltage, Enabled | $V_{IN} = 3V, V_{EN} = V_{IN}, C_{OUT} = 1000pF, R_L = 2k\Omega$ | 4.5 | 5 | | V |
| | $V_{IN} = 5V, V_{EN} = V_{IN}, C_{OUT} = 1000pF, R_L = 2k\Omega$ | 8.1 | 9 | | V |
| Output Voltage, Disabled | $V_{IN} = 3V, V_{EN} = GND, C_{OUT} = 1000pF, R_L = 2k\Omega$ | .9 | 1.0 | 1.3 | V |
| | $V_{IN} = 5V, V_{EN} = GND, C_{OUT} = 1000pF, R_L = 2k\Omega$ | 2.9 | 3.0 | 3.3 | V |
| Input Current | $V_{IN} = 3V, V_{EN} = V_{IN}, R_L = 2k\Omega$ | | 14.5 | 19.5 | mA |
| | $V_{IN} = 5V, V_{EN} = V_{IN}, R_L = 2k\Omega$ | | 28.5 | 38.5 | mA |
| Quiescent Current | $V_{IN} = 3V, V_{EN} < 0.4V$ | 1.5 | | 3 | μA |
| | $V_{IN} = 5V, V_{EN} < 0.4V$ | 3.5 | | 5 | μA |
| Output Current | $V_{IN} = 3V, V_{EN} = V_{IN}, V_{OUT} = V_{OUT\ min}$ | 1.9 | 2.5 | | mA |
| | $V_{IN} = 5V, V_{EN} = V_{IN}, V_{OUT} = V_{OUT\ min}$ | 3.4 | 4.5 | | mA |
| Enable Threshold | $V_{IN} = 3V$ | | 1.5 | | V |
| | $V_{IN} = 5V$ | | 2.5 | | V |
| Enable Current | $V_{IN} = 5V, V_{EN} = V_{IN}$ | | | 10 | μA |
| Turn-On Time | $V_{IN} = 3V$ Load = $2k\Omega, C_{OUT} = 1000pF$, Note 2 | | 200 | | ns |
| Turn-Off Time | $V_{IN} = 3V$ Load = $2k\Omega, C_{OUT} = 1000pF$, Note 3 | | 1.3 | | μs |

General Note: Devices are ESD protected, however handling precautions are recommended.

Note 1: Typical values at $T_A = 25^{\circ}C$. Minimum and maximum values at $-40^{\circ}C \leq T_A \leq +85^{\circ}C$.

Note 2: Turn-on time is the time between $V_{EN} = 0.5 \times V_{IN}$ and $V_{OUT} = 0.9 (V_{OUT\ max} - V_{OUT\ min})$ for a rising EN input.

Note 3: Turn-off time is the time between $V_{EN} = 0.5 \times V_{IN}$ and $V_{OUT} = V_{IN} - 1.9V$ for a falling EN input.

Typical Characteristics

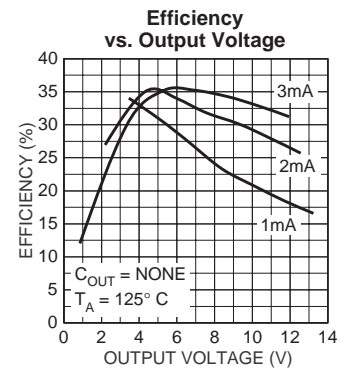
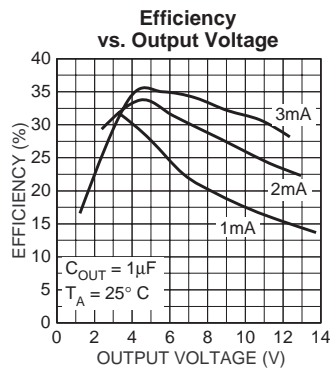
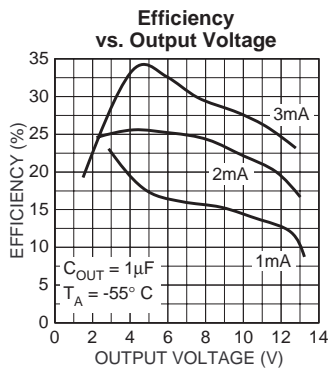
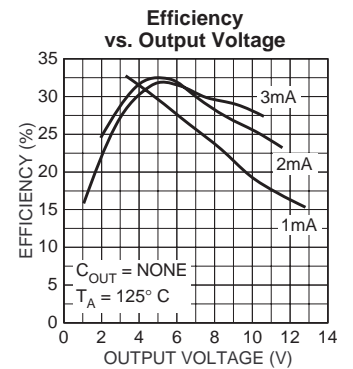
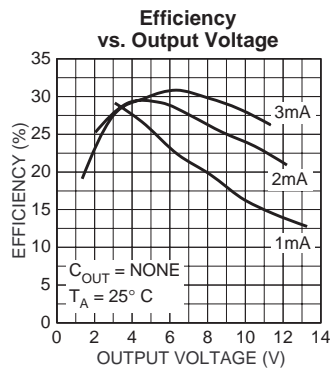
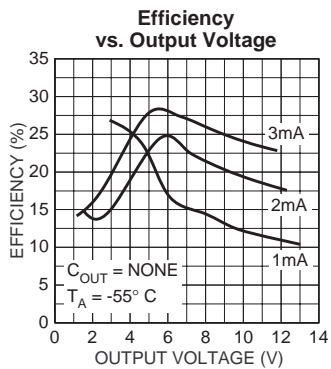
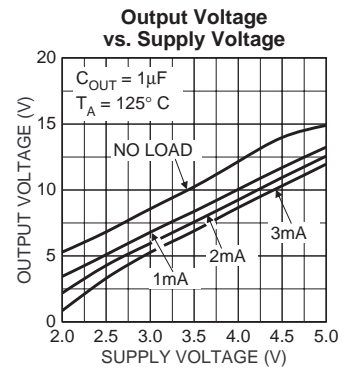
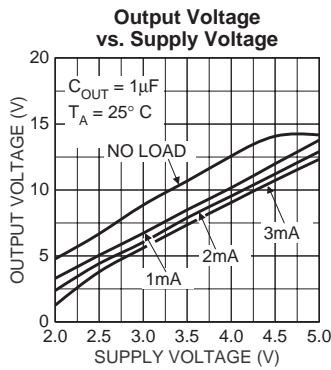
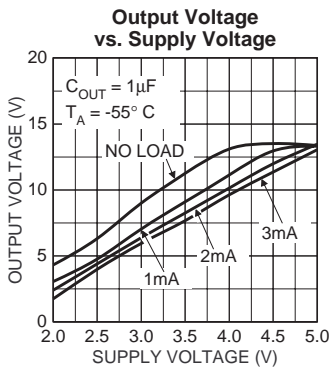
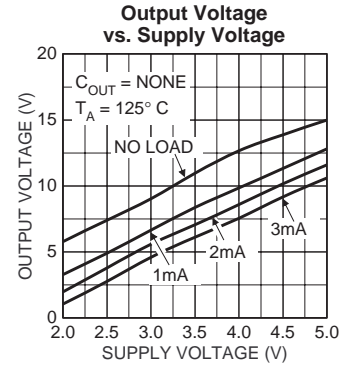
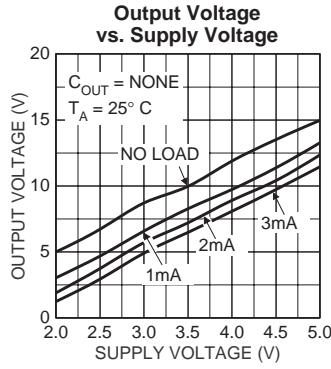
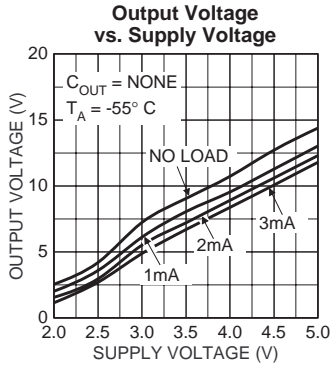

Block Diagram

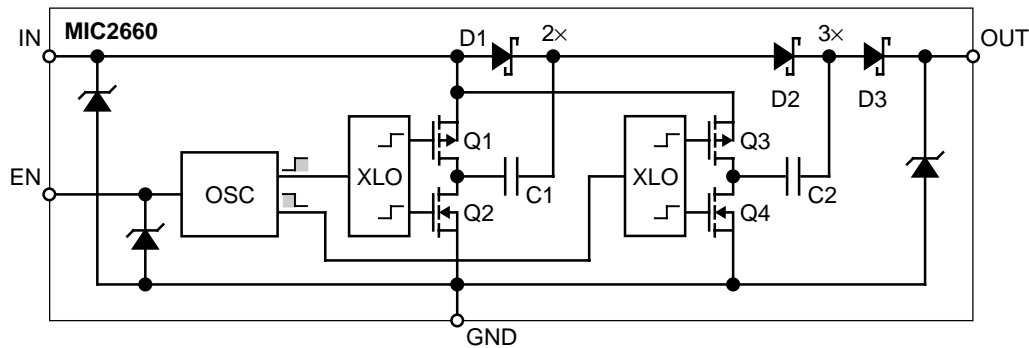

Functional Description

Refer to the block diagram.

The MIC2660 charge pump consists of an oscillator and a voltage tripler. A logic-high applied to EN activates the charge pump. The charge pump produces an output voltage that is higher than the input voltage.

Supply Input

IN (supply input) is rated for +2.7V to +5.5V.

Output

OUT is connected to IN, less 3 diode drops, at all times.

Enable

EN (enable) is a CMOS input. A logic low turns the oscillator off. The threshold is approximately half the supply voltage. A floating EN input may cause unpredictable operation.

Oscillator

The oscillator produces a square wave at approximately 18MHz. It has a noninverting and an inverting output.

Crossover Lockout

The charge pump contains two crossover lockout (XLO) circuits. Each crossover lockout circuit drives a totem pole, consisting of a P-channel MOSFET and an N-channel MOSFET. The crossover lockout alternately switches the MOSFETs with no significant transition current (shoot-through current from supply to ground).

Tripler

Voltage stepup is performed by charging an internal capacitor then switching the charged capacitor in series with the supply voltage to produce a higher voltage. A description of the nominal voltage tripler output is:

$$V_{OUT} = 3V_{IN} - 3V_D$$

where:

V_{OUT} = output voltage

V_{IN} = supply voltage

V_D = voltage drop across forward biased diode

All formulas are simplified. Refer to the last paragraph of this subsection about the actual output voltage.

The following sequence describes the basic operation of the tripler by showing how the voltage at the “2x” and “3x” nodes, V_{2x} and V_{3x} , increases.

Q2 turns on, completing the ground path to charge C1 (and the 2x node) to the supply voltage, less a diode voltage drop.

$$V_{2x \text{ (charging)}} = V_{IN} - V_{D1}$$

After Q2 turns off, Q1 turns on. The Q1-Q2 side of C1 is switched (offset upward) from ground to V_{IN} . The 2x node, that was nominally at the supply voltage, becomes nominally twice the supply voltage.

$$V_{2x} = V_{IN} - V_{D1} + V_{IN}$$

While Q1 is on, Q4 is also on. When Q4 is on, the nominally doubled voltage at the 2x node is applied across C2, through D2.

$$V_{3x \text{ (charging)}} = V_{IN} - V_{D1} + V_{IN} - V_{D2}$$

After Q4 turns off, Q3 turns on. The Q3-Q4 side of C2 is switched from ground to V_{IN} . The 3x node, that was nominally twice the supply voltage, becomes nominally three times the supply voltage.

$$V_{3x} = V_{IN} - V_{D1} + V_{IN} - V_{D2} + V_{IN}$$

The tripled voltage is available at the output through D3.

$$V_{OUT} = V_{IN} - V_{D1} + V_{IN} - V_{D2} + V_{IN} - V_{D3}$$

The output is nominally 3 times the supply voltage less the voltage drop across three diodes.

The actual output is lower. These simplified formulas do not show that the voltage across the capacitors decreases when charge flows to the following stage or output. An actual device also has some internal loss.

ESD Protection

Zener diodes are provided at IN, EN, and OUT to limit ESD voltage.

Applications Information

Electromagnetic Interference

The 18MHz oscillator may cause interference to radio circuits. 0.01µF bypass capacitors should be mounted close to the IN and OUT terminals.

Low-Side MOSFET Charge-Pump Driver

A standard MOSFET requires approximately 15V to fully enhance the gate for minimum $R_{DS(on)}$. Substituting a logic-level MOSFET reduces the required gate voltage, allowing an MIC2660 to be used as a low-side FET driver.

A 3V powered MIC2660 will fully enhance a **logic-level** N-channel MOSFET low-side switch, with a 5k gate pull-down resistor, in less than 1ms after the enable pin rises above 1.5V. The 1nF MOSFET gate capacitance will be discharged to turn-off in less than 10ms after the enable pin goes below 1.5V.

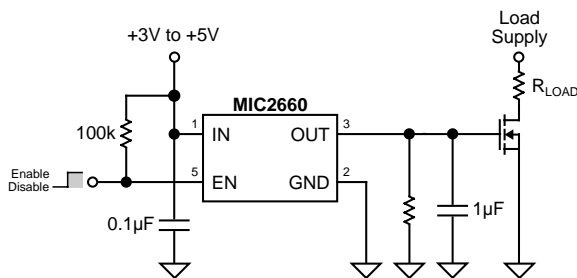

Figure 1. Charge-Pump Driver

An MIC2660 boosts a 5V input to 9V–12V to fully enhance an N-channel MOSFET, which may have its drain connected to a higher voltage, through a high-side load. A TTL high signal applied to CS enables the internal oscillator, which quickly develops 9V–12V at the gate of the MOSFET, clamped by a zener diode. A resistor from the gate to ground ensures that the FET will turn off quickly when the MIC2660 is turned off.

Charge-Pump/Dump

A large capacitor can be charged to the **unloaded** tripled voltage output after a time based on the maximum current provided by the MIC2660. A 1000µF Capacitor can be charged from 2V to approximately 12V in less than 3 seconds by a 5V powered MIC2660. ($i = C dv/dt$).

Once charged, a maximum current of 3mA may be drawn continuously at the 12V level. A high value bleeder resistor (100k) is not needed to prevent spikes from exceeding the capacitor voltage rating, since the MIC2660's internal 15V ESD zener limits maximum output. A 68Ω resistor in series with the output limits short-circuit current to 30mA.

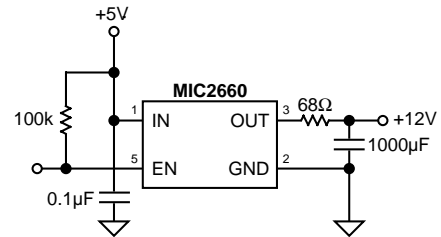

Figure 2. Charge-Pump/Dump

5-Volt Lamp Flasher

An IttyBitty MIC1557 oscillator provides a short pulse once per second, enabling the CS pin of an MIC2660, which charges the gate-to-drain capacitance of a logic-level N-channel MOSFET to approximately 9V, which turns on a lamp. When the CS pin is low, a 2k resistor discharges the gate capacitance, turning off the lamp. A resistor (R_S) in series with a diode determines the “on” time to approximately $R_S || R_T \times C_T$, while R_T and C_T set the “off” time to $1.1R_T \times C_T$.

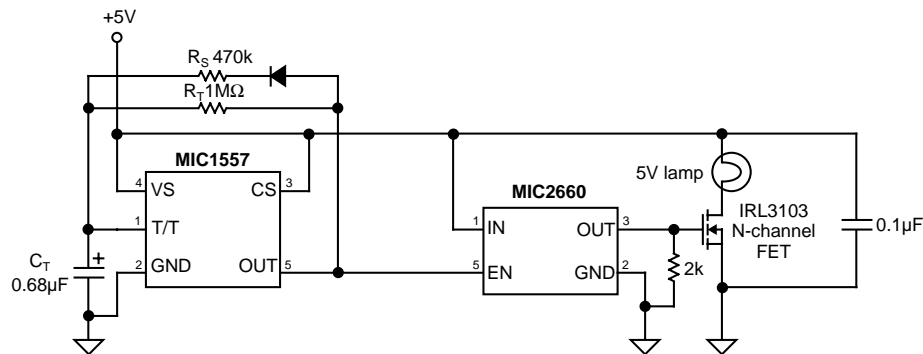
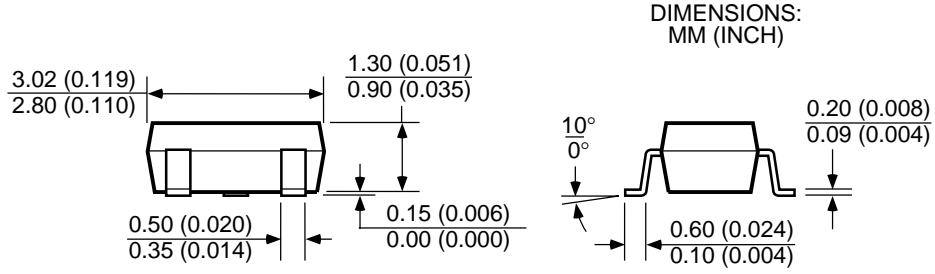
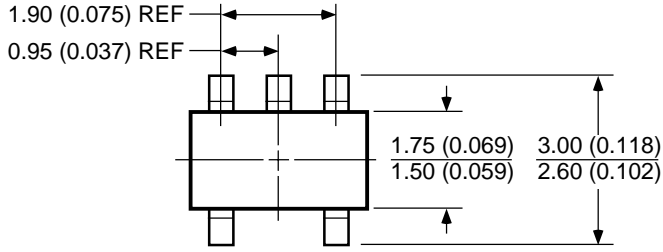

Figure 3. 5-Volt Lamp Flasher

Package Information



SOT-23-5 (M5)

MICREL INC. 1849 FORTUNE DRIVE SAN JOSE, CA 95131 USA

TEL + 1 (408) 944-0800 FAX + 1 (408) 944-0970 WEB <http://www.micrel.com>

This information is believed to be accurate and reliable, however no responsibility is assumed by Micrel for its use nor for any infringement of patents or other rights of third parties resulting from its use. No license is granted by implication or otherwise under any patent or patent right of Micrel Inc.

© 1999 Micrel Incorporated