



MIC5206

150mA Low-Noise LDO Regulator

General Description

The MIC5206 is an efficient linear voltage regulator with very low dropout voltage (typically 17mV at light loads and 165mV at 150mA), and very low ground current (600µA at 100mA output), with better than 1% initial accuracy. It has a logic compatible enable/shutdown control input and an internal undervoltage monitor.

Designed especially for hand-held, battery-powered devices, the MIC5206 can be switched by a CMOS or TTL compatible logic signal. When disabled, power consumption drops nearly to zero. Dropout ground current is minimized to prolong battery life.

Key features include an undervoltage monitor with an error flag output, a reference bypass pin to improve its already low-noise performance (8-lead versions only), reversed-battery protection, current limiting, and overtemperature shutdown.

The MIC5206 is available in several fixed voltages in a tiny SOT-23-5 package. It features a pinout, similar to the LP2980, but has significantly better performance. Fixed and adjustable output voltage versions, featuring the reference bypass option, are available in the 8-lead Micrel Mini 8™ 8-lead MSOP (micro small-outline package).

For low-dropout regulators that are stable with ceramic output capacitors, see the µCap MIC5245/6/7 family.

Features

- Error flag indicates undervoltage fault
- High output voltage accuracy
- Guaranteed 150mA output
- Ultra-low-noise output (8-lead versions)
- Low quiescent current
- Low dropout voltage
- Extremely tight load and line regulation
- Very low temperature coefficient
- Current and thermal limiting
- Reversed-battery protection
- “Zero” off-mode current
- Logic-controlled electronic enable

Applications

- Cellular telephones
- Laptop, notebook, and palmtop computers
- Battery-powered equipment
- PCMCIA V_{CC} and V_{PP} regulation/switching
- Consumer/personal electronics
- SMPS post-regulator/dc-to-dc modules
- High-efficiency linear power supplies

Typical Applications

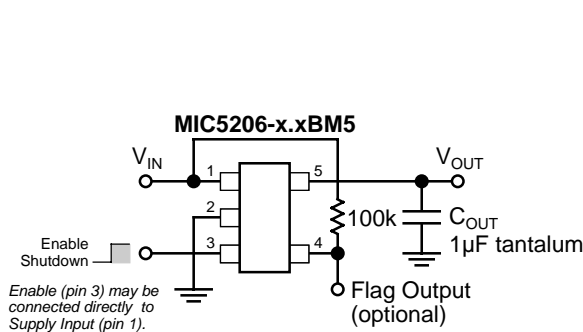

SOT-23-5 Fixed Voltage Application

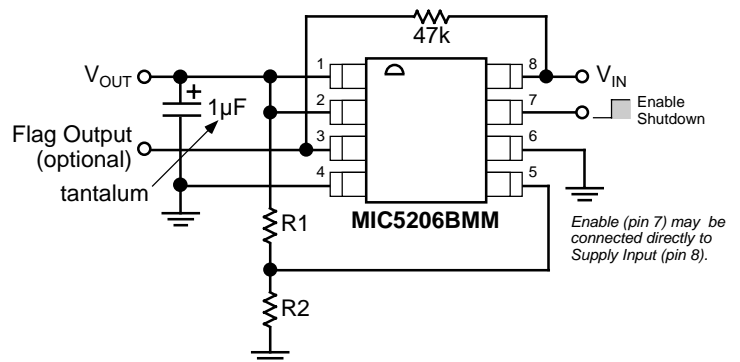

Adjustable Voltage Application

Ordering Information

Part Number	Marking	Volts	Accuracy	Junction Temp. Range	Package
MIC5206-2.5BM5	LD25	2.5	1%	-40°C to +125°C	SOT-23-5
MIC5206-2.7BM5	LD27	2.7	1%	-40°C to +125°C	SOT-23-5
MIC5206-3.0BM5	LD30	3.0	1%	-40°C to +125°C	SOT-23-5
MIC5206-3.2BM5	LD32	3.2	1%	-40°C to +125°C	SOT-23-5
MIC5206-3.3BM5	LD33	3.3	1%	-40°C to +125°C	SOT-23-5
MIC5206-3.6BM5	LD36	3.6	1%	-40°C to +125°C	SOT-23-5
MIC5206-3.8BM5	LD38	3.8	1%	-40°C to +125°C	SOT-23-5
MIC5206-4.0BM5	LD40	4.0	1%	-40°C to +125°C	SOT-23-5
MIC5206-5.0BM5	LD50	5.0	1%	-40°C to +125°C	SOT-23-5
MIC5206BMM	—	Adj	1%	-40°C to +125°C	8-lead MSOP
MIC5206-3.0BMM	—	3.0	1%	-40°C to +125°C	8-lead MSOP
MIC5206-3.3BMM	—	3.3	1%	-40°C to +125°C	8-lead MSOP
MIC5206-3.6BMM	—	3.6	1%	-40°C to +125°C	8-lead MSOP
MIC5206-3.8BMM	—	3.8	1%	-40°C to +125°C	8-lead MSOP
MIC5206-4.0BMM	—	4.0	1%	-40°C to +125°C	8-lead MSOP
MIC5206-5.0BMM	—	5.0	1%	-40°C to +125°C	8-lead MSOP

Other voltages available. Contact Micrel for details.

Pin Configuration

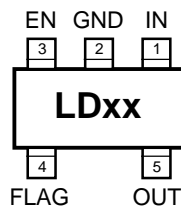

MIC5206-xxBM5
(Fixed Output Voltage)

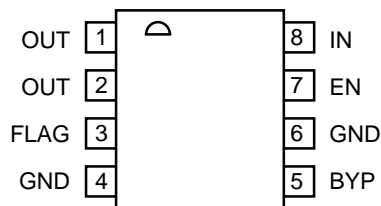

MIC5206-x.xBMM
(Fixed Output Voltage)

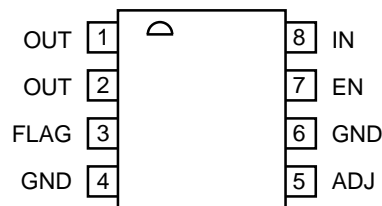

MIC5206BMM
(Adjustable Output Voltage)

Pin Description

MIC5206 SOT-23-5	MIC5206 MSOP-8	Pin Name	Pin Function
1	8	IN	Supply Input
2	4, 6	GND	Ground
3	7	EN	Enable/Shutdown (Input): CMOS compatible input. Logic high = enable, logic low or open = shutdown. Do not leave floating.
4	3	FLAG	Error Flag (Output): Open-collector output. Active low indicates an output undervoltage condition.
	5 (fixed)	BYP	Reference Bypass: Connect external 470pF capacitor to GND to reduce output noise. May be left open.
	5 (adj.)	ADJ	Adjust (Input): Adjustable regulator feedback input. Connect to resistor voltage divider.
5	1,2	OUT	Regulator Output

Absolute Maximum Ratings (Note 1)

Supply Input Voltage (V_{IN})	–20V to +20V
Enable Input Voltage (V_{EN})	–20V to +20V
Power Dissipation (P_D)	Internally Limited, Note 3
Junction Temperature (T_J)	–40°C to +125°C
Lead Temperature (Soldering, 5 sec.)	260°C

Operating Ratings (Note 2)

Supply Input Voltage (V_{IN})	+2.5V to +16V
Enable Input Voltage (V_{EN})	0V to V_{IN}
Junction Temperature (T_J)	–40°C to +125°C
SOT-23-5 (θ_{JA})	Note 3
8-lead MSOP (θ_{JA})	Note 3

Electrical Characteristics

$V_{IN} = V_{OUT} + 1V$; $I_L = 100\mu A$; $C_L = 1.0\mu F$; $V_{EN} \geq 2.0V$; $T_J = 25^\circ C$, **bold** values indicate $-40^\circ C \leq T_J \leq +125^\circ C$; unless noted.

Symbol	Parameter	Conditions	Min	Typical	Max	Units	
V_O	Output Voltage Accuracy	variation from nominal V_{OUT}	–1		1	%	
			–2		2	%	
$\Delta V_O/\Delta T$	Output Voltage Temperature Coefficient	Note 4		40		ppm/°C	
$\Delta V_O/V_O$	Line Regulation	$V_{IN} = V_{OUT} + 1V$ to 16V		0.004	0.012	% / V	
$\Delta V_O/V_O$	Load Regulation	$I_L = 0.1mA$ to 150mA, Note 5		0.02	0.2	%	
$V_{IN} - V_O$	Dropout Voltage, Note 6	$I_L = 100\mu A$		17	50	mV	
		$I_L = 50mA$		110	150	mV	
		$I_L = 100mA$		140	250	mV	
		$I_L = 150mA$		165	300	mV	
						350	mV
I_{GND}	Quiescent Current	$V_{EN} \leq 0.4V$ (shutdown)		0.01	1	μA	
		$V_{EN} \leq 0.18V$ (shutdown)			5	μA	
I_{GND}	Ground Pin Current, Note 7	$V_{EN} \geq 2.0V$, $I_L = 100\mu A$		80	125	μA	
		$I_L = 50mA$		350	600	μA	
		$I_L = 100mA$		600	800	μA	
		$I_L = 150mA$			1000	1500	μA
				1300	1900	2500	μA
PSRR	Ripple Rejection			75		dB	
I_{LIMIT}	Current Limit	$V_{OUT} = 0V$		320	500	mA	
$\Delta V_O/\Delta P_D$	Thermal Regulation	Note 8		0.05		%/W	
e_{no}	Output Noise	$I_L = 50mA$, $C_L = 4.7\mu F$, 470pF from BYP to GND (MM package only)		260		nV \sqrt{Hz}	

Enable Input

V_{IL}	Enable Input Logic-Low Voltage	regulator shutdown			0.4	V
					0.18	V
V_{IH}	Enable Input Logic-High Voltage	regulator enabled	2.0			V
I_{IL}	Enable Input Current	$V_{IL} \leq 0.4V$		0.01	–1	μA
		$V_{IL} \leq 0.18V$			–2	μA
I_{IH}		$V_{IH} \geq 2.0V$		5	20	μA
		$V_{IH} \geq 2.0V$			25	μA

Error Flag Output

V_{ERR}	Flag Threshold	undervoltage condition (below nominal) Note 9	–2	–6	–10	%
V_{OL}	Output Logic-Low Voltage	$I_L = 1mA$, undervoltage condition		0.2	0.4	V
I_{FL}	Flag Leakage Current	flag off, $V_{FLAG} = 0V$ to 16V	–1	0.1	+1	μA

- Note 1:** Exceeding the absolute maximum rating may damage the device.
- Note 2:** The device is not guaranteed to function outside its operating rating.
- Note 3:** The maximum allowable power dissipation at any T_A (ambient temperature) is $P_{D(max)} = (T_{J(max)} - T_A) \div \theta_{JA}$. Exceeding the maximum allowable power dissipation will result in excessive die temperature, and the regulator will go into thermal shutdown. The θ_{JA} of the MIC5205-x.xBM5 (all versions) is 220°C/W, and the MIC5206-x.xBMM (all versions) is 200°C/W, mounted on a PC board (see “Thermal Considerations” for further details).
- Note 4:** Output voltage temperature coefficient is defined as the worst case voltage change divided by the total temperature range.
- Note 5:** Regulation is measured at constant junction temperature using low duty cycle pulse testing. Parts are tested for load regulation in the load range from 0.1mA to 150mA. Changes in output voltage due to heating effects are covered by the thermal regulation specification.
- Note 6:** Dropout Voltage is defined as the input to output differential at which the output voltage drops 2% below its nominal value measured at 1V differential.
- Note 7:** Ground pin current is the regulator quiescent current plus pass transistor base current. The total current drawn from the supply is the sum of the load current plus the ground pin current.
- Note 8:** Thermal regulation is defined as the change in output voltage at a time “t” after a change in power dissipation is applied, excluding load or line regulation effects. Specifications are for a 150mA load pulse at $V_{IN} = 16V$ for $t = 10ms$.
- Note 9:** The error flag comparator includes 3% hysteresis.

Typical Characteristics

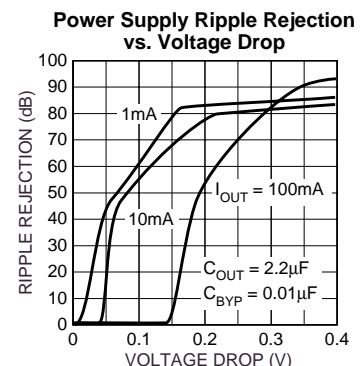
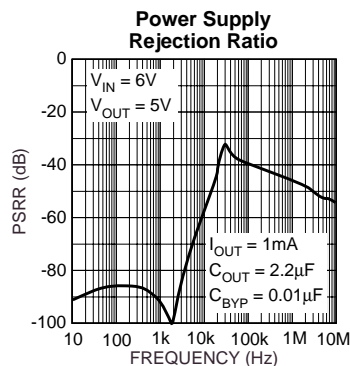
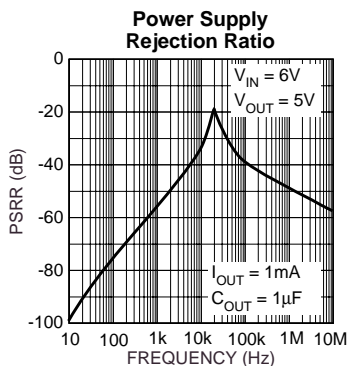
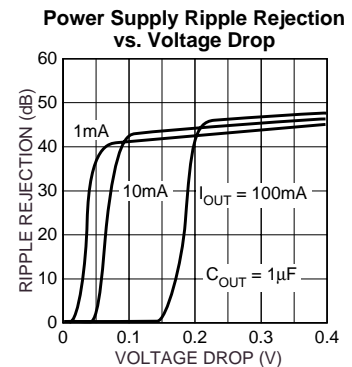
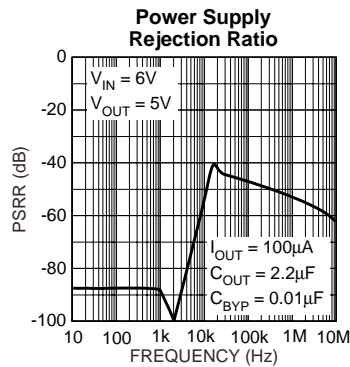
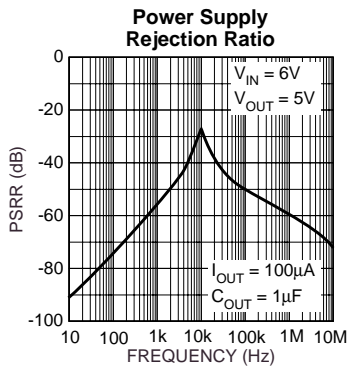

Typical Characteristics

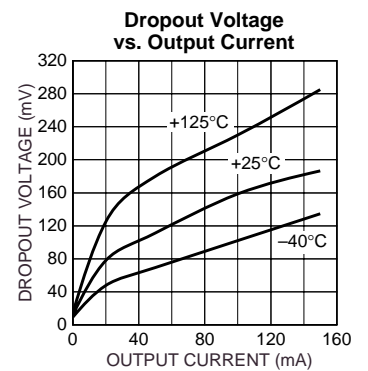
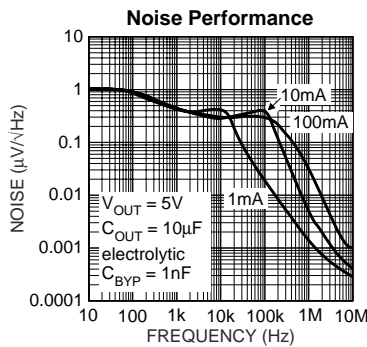
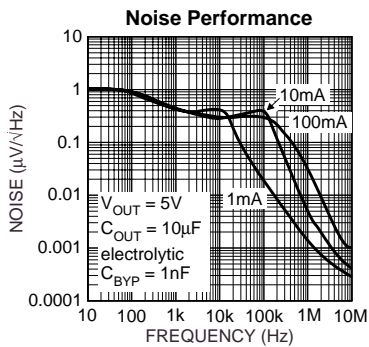
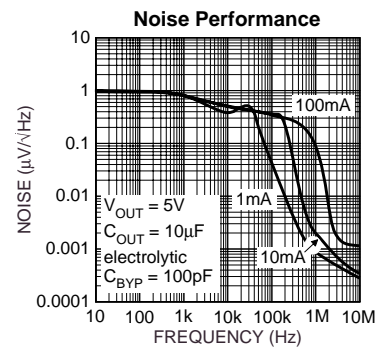
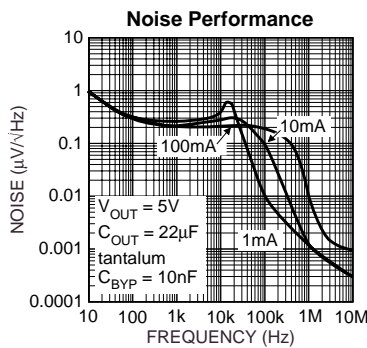
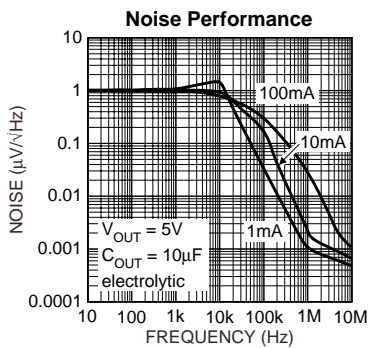
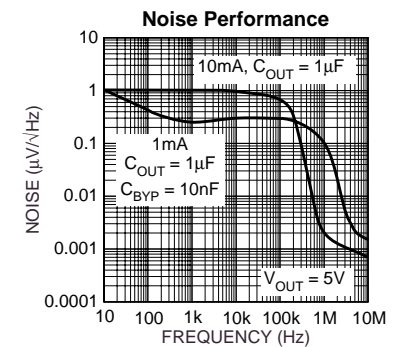
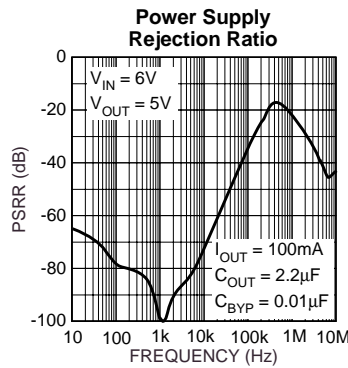
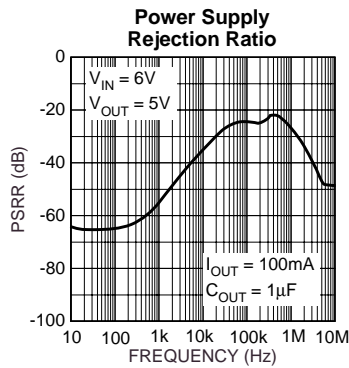
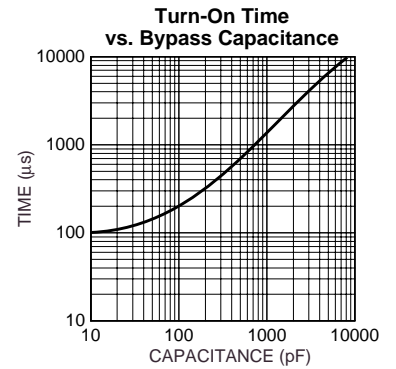
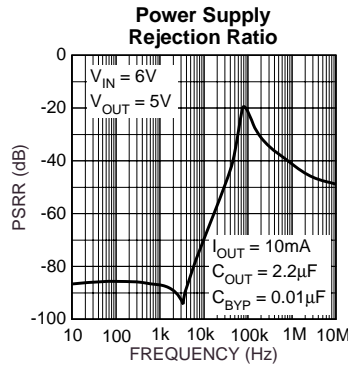
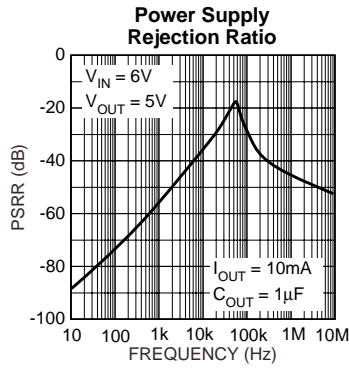

Applications Information

Enable/Shutdown

Forcing EN (enable/shutdown) high (> 2V) enables the regulator. EN is compatible with CMOS logic gates.

If the enable/shutdown feature is not required, connect EN (enable) to IN (supply input). Refer to the text with Figures 1a and 2.

Input Capacitor

A 1 μ F capacitor should be placed from IN to GND if there is more than 10 inches of wire between the input and the ac filter capacitor or if a battery is used as the input.

Reference Bypass Capacitor

BYP (reference bypass) is connected to the internal voltage reference. A 470pF capacitor (C_{BYP}) connected from BYP to GND quiets this reference, providing a significant reduction in output noise. See Figure 2. C_{BYP} reduces the regulator phase margin; when using C_{BYP} , output capacitors of 2.2 μ F or greater are generally required to maintain stability.

The start-up speed of the MIC5206 is inversely proportional to the size of the reference bypass capacitor. Applications requiring a slow ramp-up of output voltage should consider larger values of C_{BYP} . Likewise, if rapid turn-on is necessary, consider omitting C_{BYP} .

If output noise is not a major concern, omit C_{BYP} and leave BYP open.

Output Capacitor

An output capacitor is required between OUT and GND to prevent oscillation. The minimum size of the output capacitor is dependent upon whether a reference bypass capacitor is used. 1.0 μ F minimum is recommended when C_{BYP} is not used (see Figure 2). 2.2 μ F minimum is recommended when C_{BYP} is 470pF (see Figure 2). Larger values improve the regulator's transient response. The output capacitor value may be increased without limit.

The output capacitor should have an ESR (effective series resistance) of about 5 Ω or less and a resonant frequency above 1MHz. Most tantalum or aluminum electrolytic capacitors are adequate; film types will work, but are more expensive. Since many aluminum electrolytics have electrolytes that freeze at about -30°C, solid tantalums are recommended for operation below -25°C.

At lower values of output current, less output capacitance is required for output stability. The capacitor can be reduced to 0.47 μ F for current below 10mA or 0.33 μ F for currents below 1mA.

No-Load Stability

The MIC5205 will remain stable and in regulation with no load (other than the internal voltage divider) unlike many other voltage regulators. This is especially important in CMOS RAM keep-alive applications.

Error Flag Output

The error flag is an open-collector output and is active (low) when an undervoltage of approximately 5% below the nominal output voltage is detected. A pullup resistor from IN to FLAG is shown in all schematics.

If an error indication is not required, FLAG may be left open and the pullup resistor may be omitted.

Enable Pin Ramp and the Error Flag

To prevent indeterminate behavior on the error flag during power down of the device, ensure that the fall time of the enable pin signal, from logic high to logic low, is faster than 100 μ s.

Fixed Regulator Applications

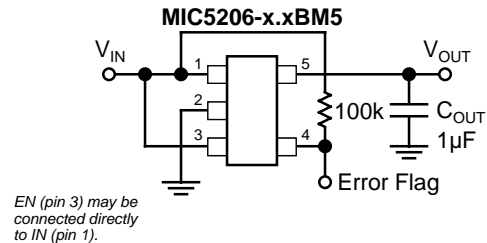

Figure 1a. Low-Noise Fixed Voltage Application

EN (pin 3) is shown connected to IN (pin 1) for an application where enable/shutdown is not required. The error flag is shown with a 100k Ω pullup resistor.

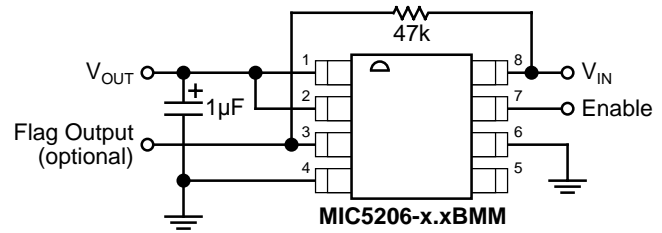

Figure 1b. Low-Noise Fixed Voltage Application

Figure 1b is an example of a basic configuration where the lowest-noise operation is not required. $C_{OUT} = 1\mu$ F minimum. The error flag is shown with a 47k Ω pullup resistor.

Ultra-Low-Noise Application

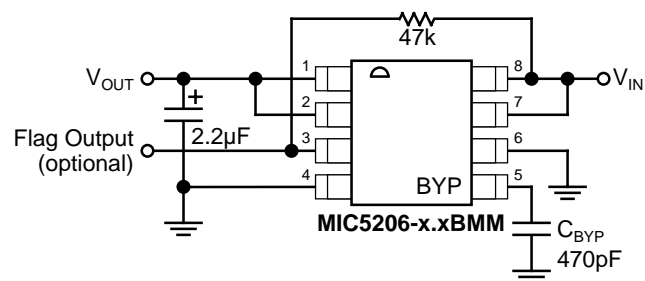

Figure 2. Ultra-Low-Noise Fixed Voltage Application

Figure 2 includes a 470pF capacitor for low-noise operation and shows EN (pin 7) connected to IN (pin 8) for an application where enable/shutdown is not required. The error flag is shown with a 47k Ω pullup resistor.

Adjustable Regulator Applications

Figure 3 shows the MIC5206BMM adjustable output voltage configuration. Two resistors set the output voltage. The formula for output voltage is:

$$V_{OUT} = 1.242V \times \left(\frac{R2}{R1} + 1 \right)$$

Resistor values are not critical because ADJ (adjust) has a high input impedance, but for best results use resistors of 470kΩ or less. A capacitor from ADJ to ground provides greatly improved noise performance.

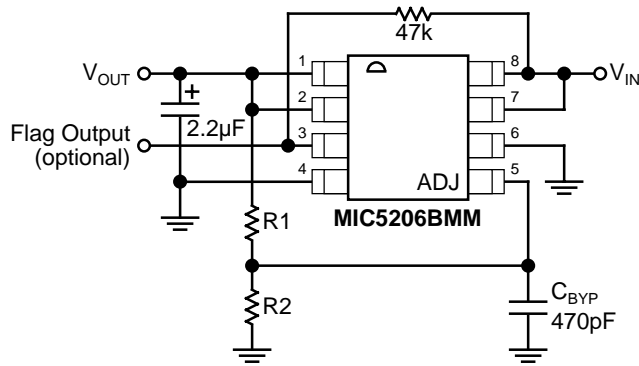

Figure 3. Ultra-Low-Noise Adjustable Voltage Application

Figure 3 also includes a 470pF capacitor for lowest-noise operation and shows EN (pin 7) connected to IN (pin 8) for an application where enable/shutdown is not required. C_{OUT} = 2.2µF minimum. The error flag is shown with a 47kΩ pullup resistor.

Thermal Considerations

Layout

The MIC5206-x.xBM5 (5-lead SOT-23 package) has the following thermal characteristics when mounted on a single layer copper-clad printed circuit board.

Multilayer boards having a ground plane, wide traces near the pads, and large supply bus lines provide better thermal conductivity.

PC Board Dielectric	θ_{JA}
FR4	220°C/W
Ceramic	200°C/W

SOT-23-5 Thermal Characteristics

The “worst case” value of 220°C/W assumes no ground plane, minimum trace widths, and a FR4 material board.

The MIC5206-xxBMM (8-lead MSOP) has a thermal resistance of 200°C/W when mounted on a FR4 board with minimum trace widths and no ground plane.

PC Board Dielectric	θ_{JA}
FR4	200°C

MSOP Thermal Characteristics

Nominal Power Dissipation and Die Temperature

The MIC5206-x.xBM5 at a 25°C ambient temperature will operate reliably at over 450mW power dissipation when mounted in the “worst case” manner described above. At an ambient temperature of 40°C, the device may safely dissipate over 380mW. These power levels are equivalent to a die temperature of 125°C, the maximum operating junction temperature for the MIC5206.

For additional heat sink characteristics, please refer to Micrel Application Hint 17, “Calculating P.C. Board Heat Sink Area For Surface Mount Packages”.

Package Information

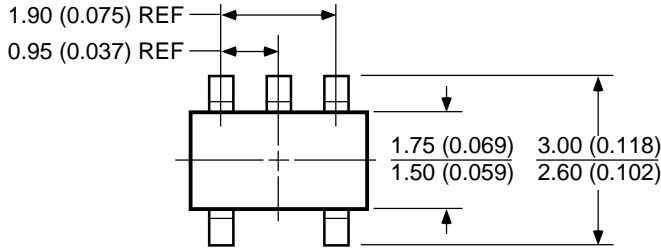

DIMENSIONS:
MM (INCH)

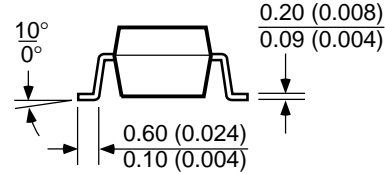
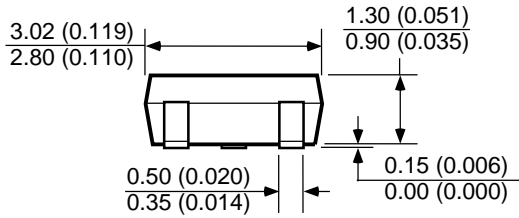

SOT-23-5 (M5)

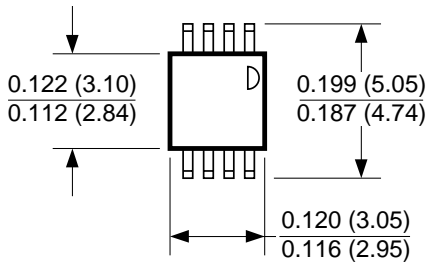

DIMENSIONS:
INCH (MM)

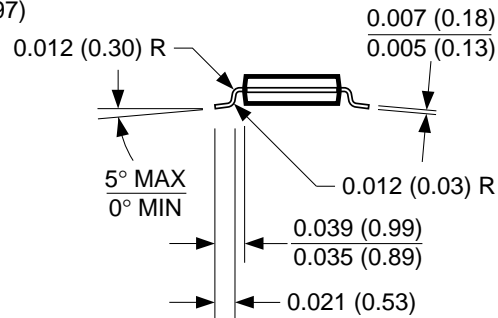
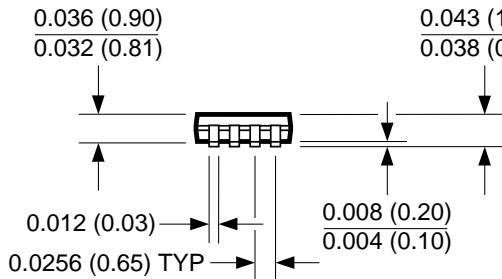

8-Lead MSOP (MM)

MICREL INC. 1849 FORTUNE DRIVE SAN JOSE, CA 95131 USA

TEL + 1 (408) 944-0800 FAX + 1 (408) 944-0970 WEB <http://www.micrel.com>

This information is believed to be accurate and reliable, however no responsibility is assumed by Micrel for its use nor for any infringement of patents or other rights of third parties resulting from its use. No license is granted by implication or otherwise under any patent or patent right of Micrel Inc.

© 2000 Micrel Incorporated