



The Infinite Bandwidth Company™

# MIC6211

## IttyBitty™ Operational Amplifier

### Final Information

### General Description

The MIC6211 IttyBitty™ op amp is a general-purpose, high-performance, single- or split-supply, operational amplifier in a space-saving, surface-mount package.

The MIC6211 operates from 4V to 32V, single or differential (split) supply. The input common-mode range includes ground. The device features a 2.5MHz unity gain bandwidth, 6V/μs slew rate, and is internally unity-gain compensated.

Inputs are protected against reverse polarity (input voltage less than V-) and ESD (electrostatic discharge). Output is current limited for both sourcing and sinking. Output short circuits of unlimited duration are allowed, provided the power dissipation specification is not exceeded.

The MIC6211 is available in the tiny, 5-lead SOT-23-5 surface-mount package.

### Features

- 4V to 32V operation
- Small footprint package
- Unity gain stable
- 2.5 MHz unity gain bandwidth
- 6V/μs typical slew rate
- Short circuit protected

### Applications

- Analog blocks
- Active filtering

### Ordering Information

Part Number	Temperature Range	Package
MIC6211BM5	-40°C to +85°C	SOT-23-5

### Pin Configuration

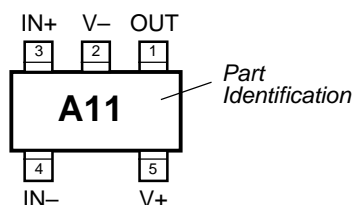

### Functional Configuration

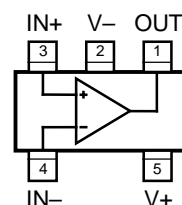

SOT-23-5 (M5)

### Pin Description

Pin Number	Pin Name	Pin Function
1	OUT	Amplifier Output
2	V-	Negative Supply: Negative supply for split supply application or ground for single supply application.
3	IN+	Noninverting Input
4	IN-	Inverting Input
5	V+	Positive Supply

**Absolute Maximum Ratings**

Supply Voltage ( $V_{V+} - V_{V-}$ )	36V or $\pm 18V$
Differential Input Voltage ( $V_{IN+} - V_{IN-}$ )	$\pm 36V$
Input Voltage ( $V_{IN+}, V_{IN-}$ )	( $V_{V-} - 0.3V$ ) to $V_{V+}$
Output Short Circuit Current Duration	$\infty$

**Operating Ratings**

Supply Voltage	4V to 32V
Ambient Temperature Range	$-40^{\circ}C$ to $+85^{\circ}C$
SOT-23-5 Thermal Resistance ( $\theta_{JA}$ )	220 $^{\circ}C/W$ (mounted to printed circuit board)

**Electrical Characteristics (Differential Supply)**

$V_+ = +15V$ ,  $V_- = -15V$ ,  $V_{CM} = 0V$ ;  $R_L = 2k\Omega$ ;  $T_A = 25^{\circ}C$ , **bold** values indicate  $-40^{\circ}C \leq T_A \leq +85^{\circ}C$ ,  $T_A = T_J$ ; unless noted

Symbol	Parameter	Condition	Min	Typ	Max	Units
$V_{OS}$	Input Offset Voltage			2	7	mV
$TCV_{OS}$	Average Input Offset Drift	<b>Note 1</b>		7		$\mu V/^{\circ}C$
$I_B$	Input Bias Current			50	250	nA
$I_{OS}$	Input Offset Current			8	30	nA
$V_{CM}$	Input Voltage Range		+13.5 -15.0	+13.8 -15.3		V V
CMRR	Common Mode Rejection Ratio	$V_{CM} = +13.5V, -15.0V$	65	100		dB
PSRR	Power Supply Rejection Ratio	$V_S = \pm 2.5V$ to $\pm 15V$	65	110		dB
$A_{VOL}$	Large Signal Voltage Gain	$V_O = \pm 10V$	25	180		V/mV
$V_{OUT}$	Maximum Output Voltage Swing		$\pm 12.5$	$\pm 14$		V
$B_W$	Bandwidth			2.5		MHz
$S_R$	Slew Rate			6		V/ $\mu s$
$I_{SC}$	Output Short Circuit Current	Sourcing or sinking	30	50		mA
$I_S$	Supply Current			1.3	2.0	mA

**Electrical Characteristics (Single Supply)**

$V_+ = +5V$ ,  $V_- = 0V$ ,  $V_{CM} = 0.1V$ ;  $T_A = 25^{\circ}C$ , **bold** values indicate  $-40^{\circ}C \leq T_A \leq +85^{\circ}C$ ,  $T_A = T_J$ ; unless noted

Symbol	Parameter	Condition	Min	Typ	Max	Units
$V_{OS}$	Input Offset Voltage			2	7	mV
$TCV_{OS}$	Average Input Offset Drift	<b>Note 1</b>		7		$\mu V/^{\circ}C$
$I_B$	Input Bias Current			65	250	nA
$I_{OS}$	Input Offset Current			8	30	nA
$V_{CM}$	Input Voltage Range		+3.5 0	+3.7 -0.3		V V
CMRR	Common Mode Rejection Ratio	$V_{CM} = 0V$ to $3.5V$	45	70		dB
PSRR	Power Supply Rejection Ratio	$V_S = \pm 2.5V$ to $\pm 15V$	65	105		dB
$A_{VOL}$	Large Signal Voltage Gain	$V_O = 1.5V$ to $3.5V$ , $R_L = 2k$	15	170		V/mV
$V_{OUT}$	Maximum Output Voltage Swing	$R_L = 10k$ to GND $R_L = 10k$ to $+5V$	+3.8	+4.0 +1.0	+1.2	V V
$I_{SC}$	Output Short Circuit Current	Sourcing or sinking	20	40		mA
$I_S$	Supply Current			1.2	1.8	mA

**General Note:** Devices are ESD protected; however, handling precautions are recommended.

**Note 1:** Not production tested.

# Typical Characteristics

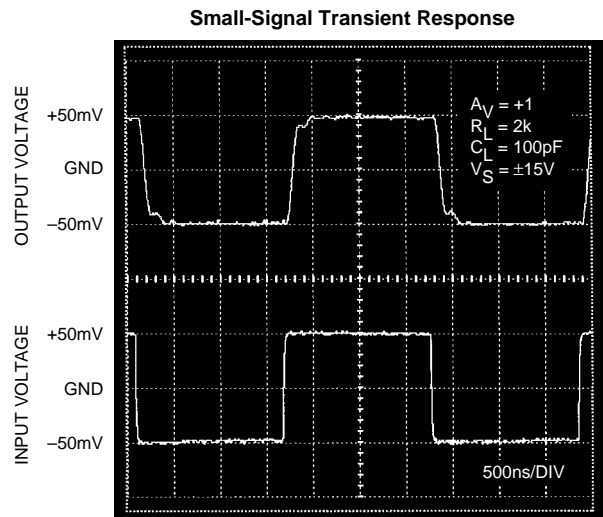
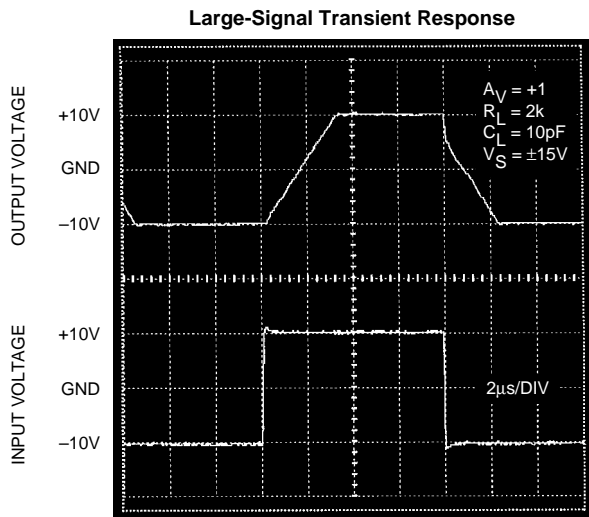
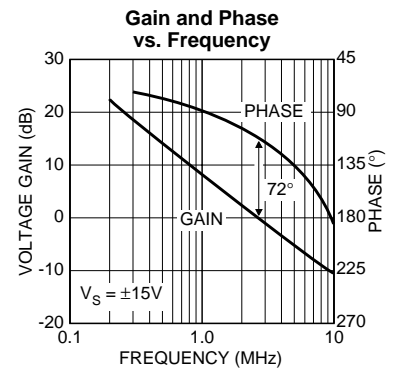
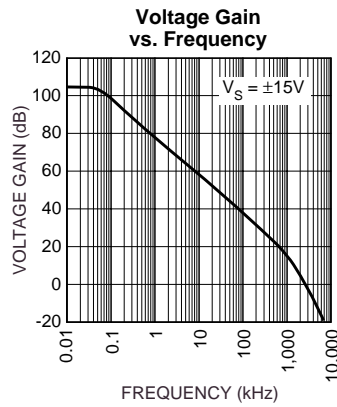
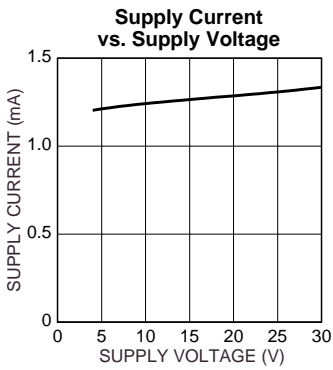
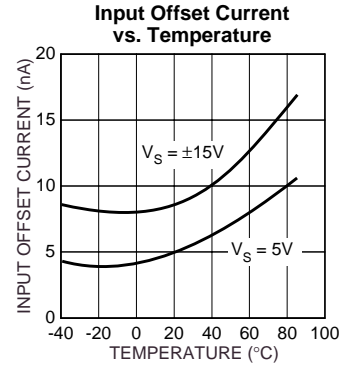
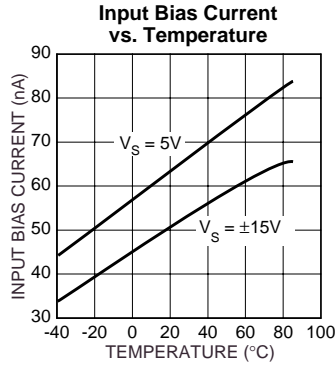
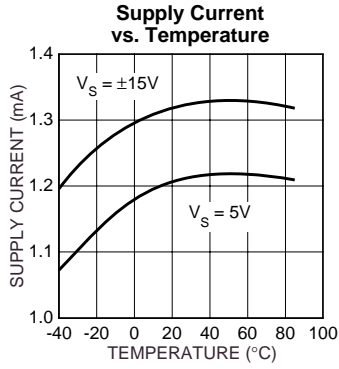

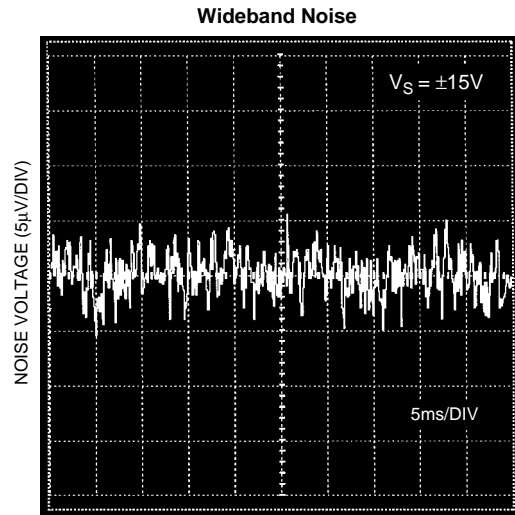
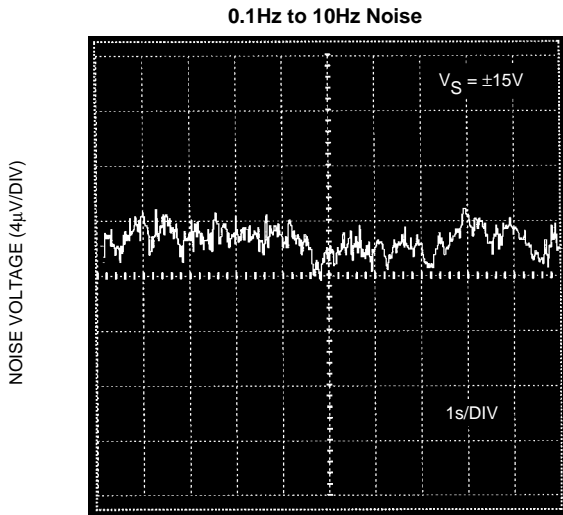
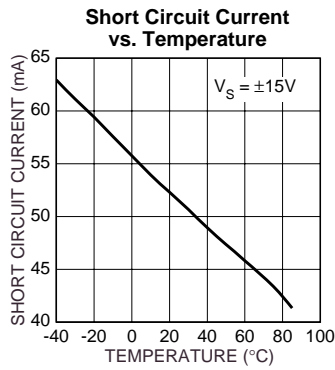
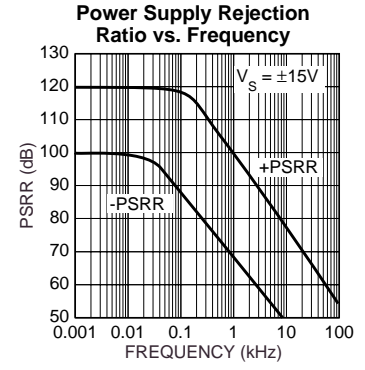
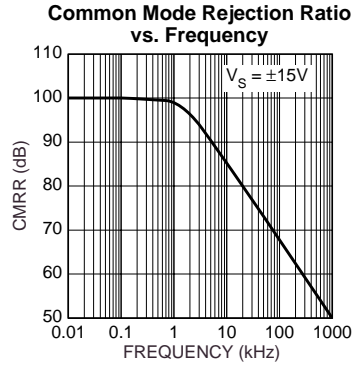
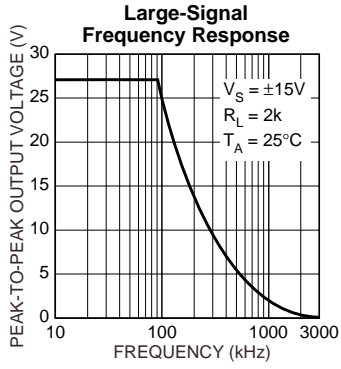

# Functional Diagram

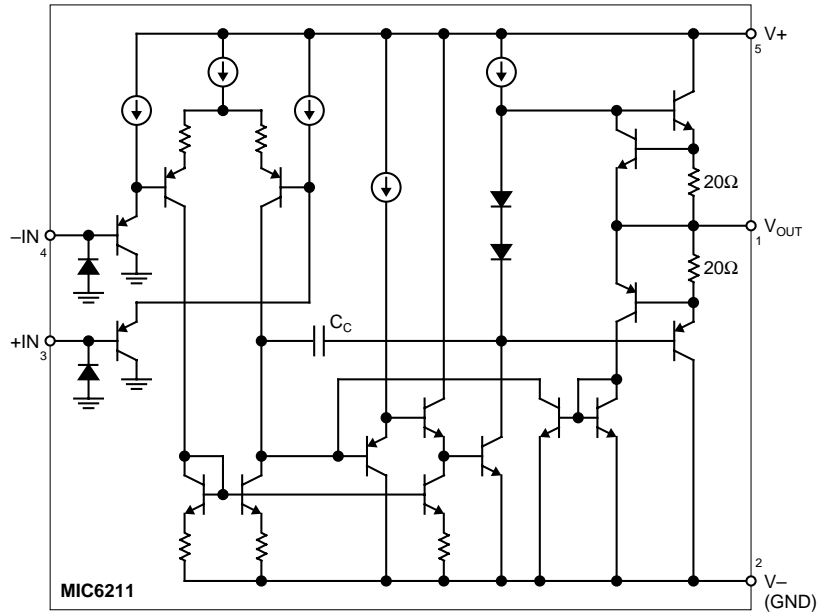

## Applications Information

### Common-Mode Range and Output Voltage

The input common-mode range of the MIC6211 is from the negative supply voltage to 1.2V below the positive supply voltage. The output voltage swings within 1V of the positive and negative supply voltage.

### Voltage Buffer

Figure 1 shows a standard voltage follower/buffer. The output voltage equals the input voltage. This circuit is used to buffer a high impedance signal source. This circuit works equally well with single or split supplies.

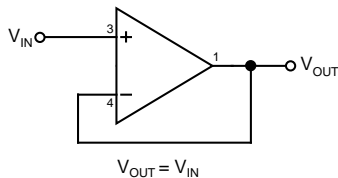

Figure 1. Voltage Buffer

### Inverting Amplifier

Figure 2 shows an inverting amplifier with its gain set by the ratio of two resistors. This circuit works best with split supplies, but will perform with single supply systems if the non-inverting input (+ input) is biased up above ground.

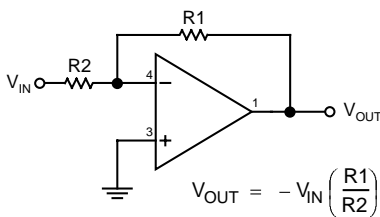

Figure 2. Inverting Amplifier

### Voltage Controlled Current Sink

Figure 3 is a voltage controlled current sink. A buffer transistor forces current through a programming resistor until the feedback loop is satisfied. Current flow is  $V_{IN}/R$ . This circuit works with single or split supplies.

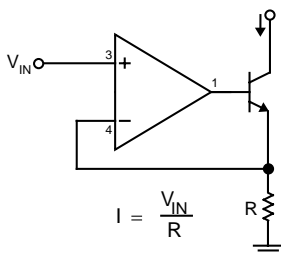

Figure 3. Voltage Controlled Current Sink

### High-Pass Filter

Figure 4 is an active filter with 20dB (10x) gain and a low-frequency cutoff of 10Hz. The high gain-bandwidth of the MIC6211 allows operation beyond 100kHz. This filter configuration is designed for split supplies.

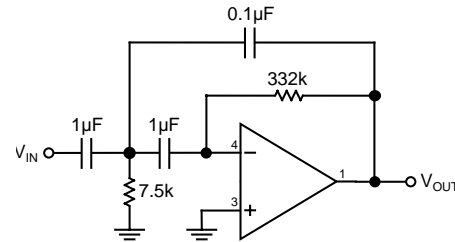

Figure 4a. High-Pass Filter

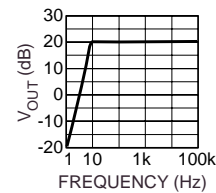
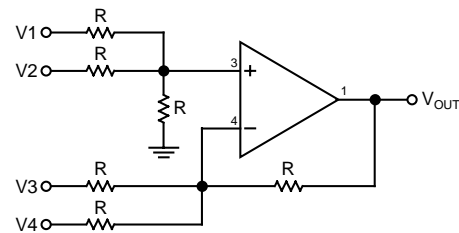

Figure 4b. High-Pass Filter Response

### Summing Amplifier

Figure 5 is a single supply summing amplifier. In this configuration, the output voltage is the sum of V1 and V2, minus the sum of V3 and V4. By adding more resistors to either the inverting or non-inverting input, more voltages may be summed. This single supply version has one important restriction: the sum of V1 and V2 must exceed the sum of V3 and V4, since the output voltage cannot pull below zero with only a single supply.



All resistors are equal.

$$V_{OUT} = V1 + V2 - V3 - V4$$

$V1 + V2 > V3 + V4$  for single supply operation

Figure 5. Summing Amplifier

### Package Information

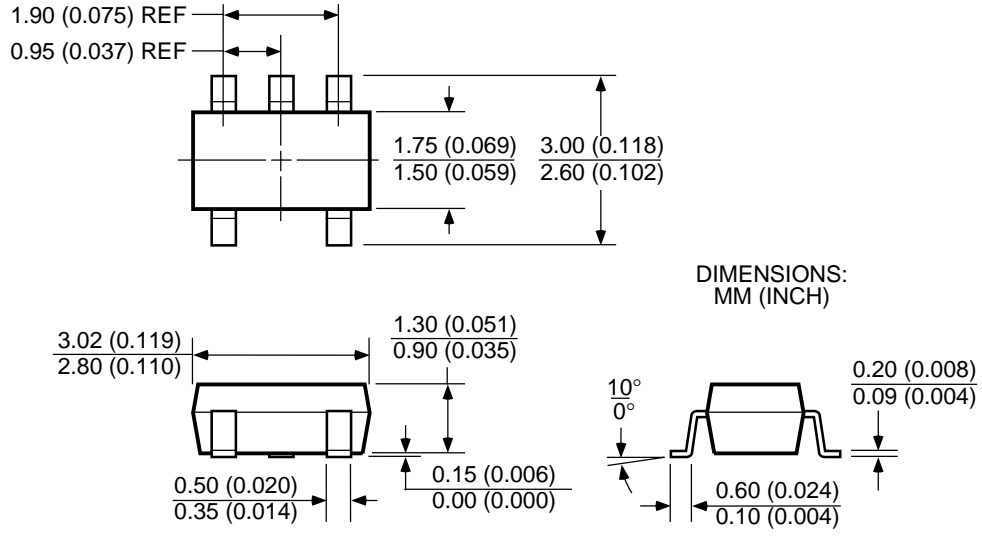

**SOT-23-5 (M5)**

---

**MICREL INC. 1849 FORTUNE DRIVE SAN JOSE, CA 95131 USA**

TEL + 1 (408) 944-0800 FAX + 1 (408) 944-0970 WEB <http://www.micrel.com>

This information is believed to be accurate and reliable, however no responsibility is assumed by Micrel for its use nor for any infringement of patents or other rights of third parties resulting from its use. No license is granted by implication or otherwise under any patent or patent right of Micrel Inc.

© 1999 Micrel Incorporated