

POWER AMPLIFIER APPLICATION.  
POWER SWITCHING APPLICATION.

### FEATURES

- Low Collector Saturation Voltage  
:  $V_{CE(sat)} = -0.5V(\text{Max.}) (I_C = -1A)$
- High Speed Switching Time :  $t_{stg} = 1 \mu s(\text{Typ.})$
- Complementary to KTC2815D/L.

### MAXIMUM RATING (Ta=25°C)

CHARACTERISTIC		SYMBOL	RATING	UNIT
Collector-Base Voltage		$V_{CBO}$	-50	V
Collector-Emitter Voltage		$V_{CEO}$	-50	V
Emitter-Base Voltage		$V_{EBO}$	-5	V
Collector Current		$I_C$	-2	A
Collector Power Dissipation	Ta=25°C	$P_C$	1.3	W
	Tc=25°C		10	
Junction Temperature		$T_j$	150	°C
Storage Temperature Range		$T_{stg}$	-55 ~ 150	°C

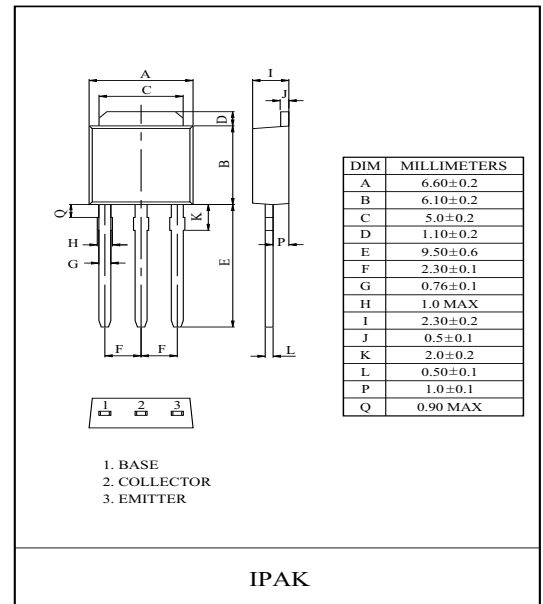
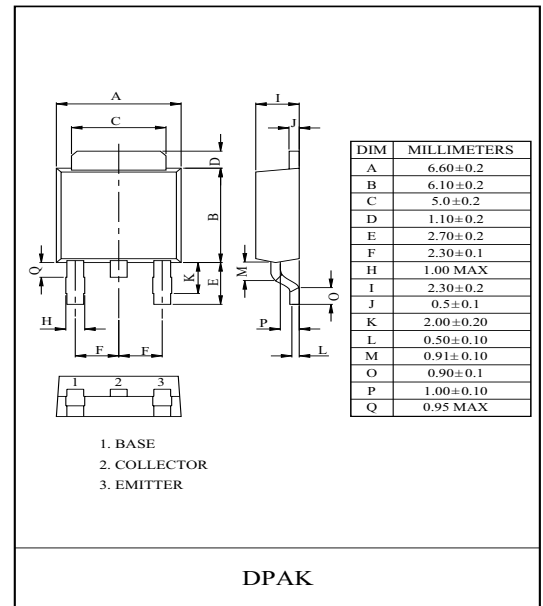

### ELECTRICAL CHARACTERISTICS (Ta=25°C)

CHARACTERISTIC		SYMBOL	TEST CONDITION	MIN.	TYP.	MAX.	UNIT
Collector Cut-off Current		$I_{CBO}$	$V_{CB} = -50V, I_E = 0$	-	-	-0.1	$\mu A$
Emitter Cut-off Current		$I_{EBO}$	$V_{EB} = -5V, I_C = 0$	-	-	-0.1	$\mu A$
Collector-Emitter Breakdown Voltage		$V_{(BR)CEO}$	$I_C = -10mA, I_B = 0$	-50	-	-	V
DC Current Gain	$h_{FE(1)}$ (Note)		$V_{CE} = -2V, I_C = -0.5A$	70	-	240	
	$h_{FE2}$		$V_{CE} = -2V, I_C = -1.5A$	40	-	-	
Collector-Emitter Saturation Voltage		$V_{CE(sat)}$	$I_C = -1A, I_B = -0.05A$	-	-	-0.5	V
Base-Emitter Saturation Voltage		$V_{BE(sat)}$	$I_C = -1A, I_B = -0.05A$	-	-	-1.2	V
Transition Frequency		$f_T$	$V_{CE} = -2V, I_C = -0.5A$	-	100	-	MHz
Collector Output Capacitance		$C_{ob}$	$V_{CB} = -10V, I_E = 0, f = 1MHz$	-	30	-	pF
Switching Time	Turn On Time	$t_{on}$	<p style="text-align: center;">-<math>I_{B1} = I_{B2} = 0.05A</math> DUTY CYCLE <math>\leq 1\%</math></p>	-	0.1	-	$\mu S$
	Storage Time	$t_{stg}$		-	1.0	-	
	Fall Time	$t_f$		-	0.1	-	

Note :  $h_{FE(1)}$  Classification O:70~140, Y:120~240.

# KTA1718D/L

STATIC CHARACTERISTICS

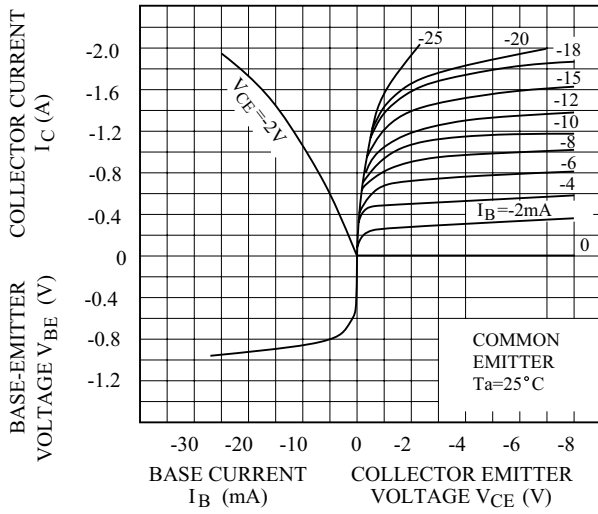

$V_{CE} - I_C$

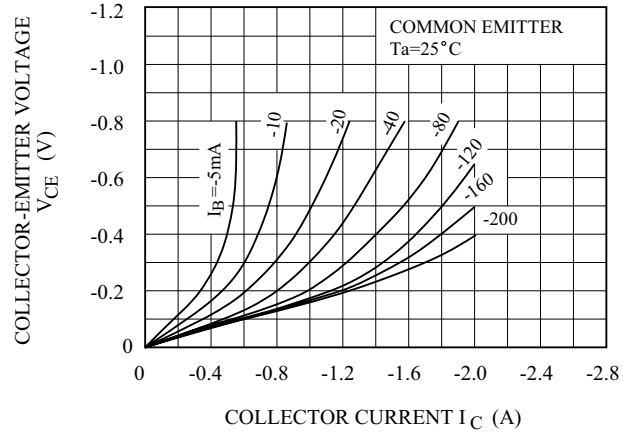

$V_{CE} - I_C$

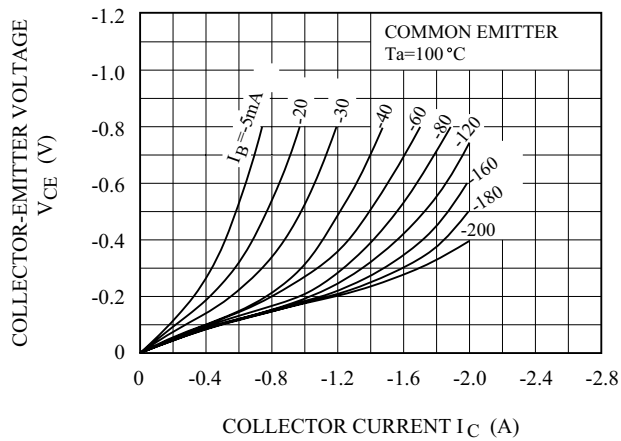

$V_{CE} - I_C$

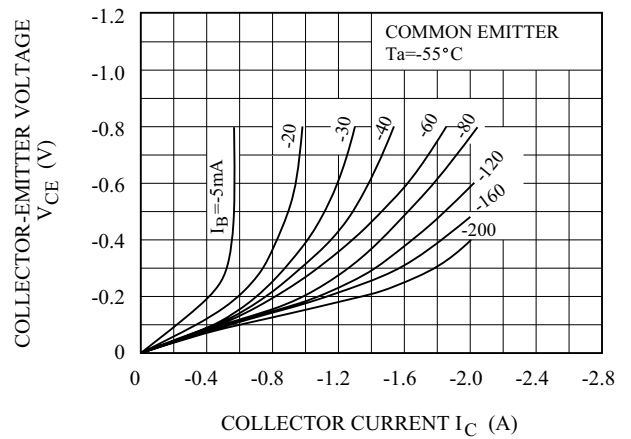

$h_{FE} - I_C$

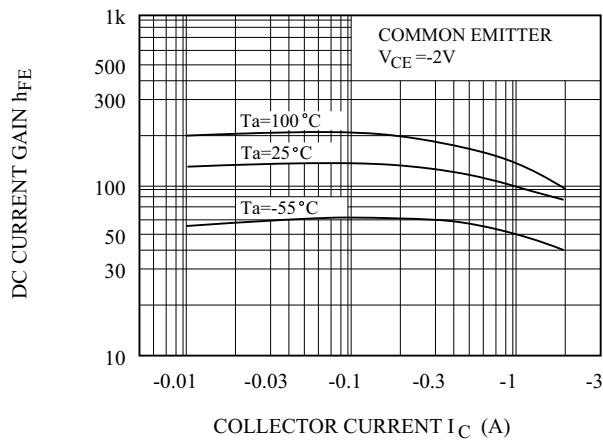

# KTA1718D/L

