

HIGH FREQUENCY APPLICATION.
VHF BAND AMPLIFIER APPLICATION.

FEATURES

- High Gain : $G_{pe}=33\text{dB(Typ.)}$ ($f=45\text{MHz}$).
- Good Linearity of h_{FE} .

MAXIMUM RATING ($T_a=25^\circ\text{C}$)

CHARACTERISTIC	SYMBOL	RATING	UNIT
Collector-Base Voltage	V_{CBO}	30	V
Collector-Emitter Voltage	V_{CEO}	25	V
Emitter-Base Voltage	V_{EBO}	4	V
Collector Current	I_C	50	mA
Emitter Current	I_E	-50	mA
Collector Power Dissipation	P_C	625	mW
Junction Temperature	T_j	150	$^\circ\text{C}$
Storage Temperature Range	T_{stg}	-55 ~ 150	$^\circ\text{C}$

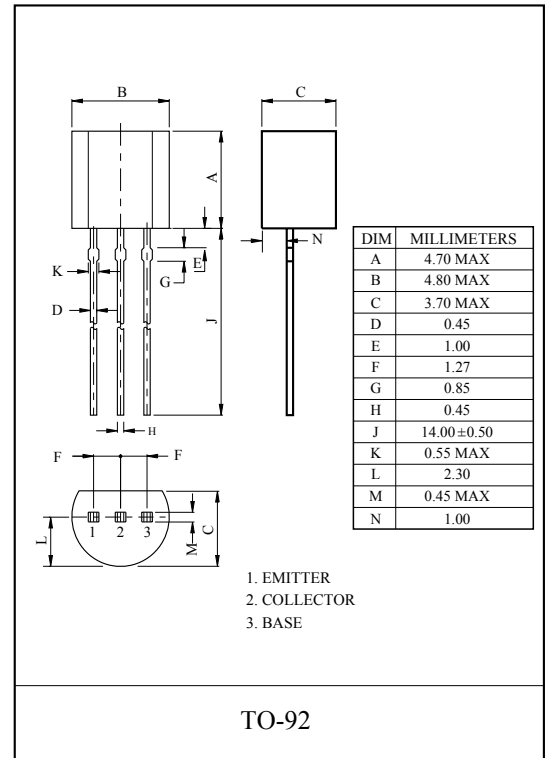

ELECTRICAL CHARACTERISTICS ($T_a=25^\circ\text{C}$)

CHARACTERISTIC		SYMBOL	TEST CONDITION	MIN.	TYP.	MAX.	UNIT
Collector Cut-off Current		I_{CBO}	$V_{CB}=30\text{V}, I_E=0$	-	-	0.1	μA
Emitter Cut-off Current		I_{EBO}	$V_{EB}=3\text{V}, I_C=0$	-	-	0.1	
Collector-Emitter Breakdown Voltage		$V_{(BR)CEO}$	$I_C=10\text{mA}, I_B=0$	25	-	-	V
DC Current Gain		h_{FE}	$V_{CE}=12.5\text{V}, I_C=12.5\text{mA}$	20	-	200	
Saturation Voltage	Collector-Emitter	$V_{CE(sat)}$	$I_C=15\text{mA}, I_B=1.5\text{mA}$	-	-	0.2	V
	Base-Emitter	$V_{BE(sat)}$		-	-	1.5	
Collector Output Capacitance		C_{ob}	$V_{CB}=10\text{V}, I_E=0, f=1\text{MHz}$	0.8	-	2.0	pF
Collector-Base Time Constant		$C_c \cdot r_{bb}$	$V_{CB}=10\text{V}, I_E=-1\text{mA}, f=30\text{MHz}$	-	-	25	pS
Transition Frequency		f_T	$V_{CE}=12.5\text{V}, I_C=12.5\text{mA}$	300	-	-	MHz
Power Gain (Fig.1)		G_{pe}	$V_{CC}=12.5\text{V}, I_E=-12.5\text{mA}, f=45\text{MHz}$	28	-	36	dB

Fig. 1 45MHz G_{pe} TEST CIRCUIT

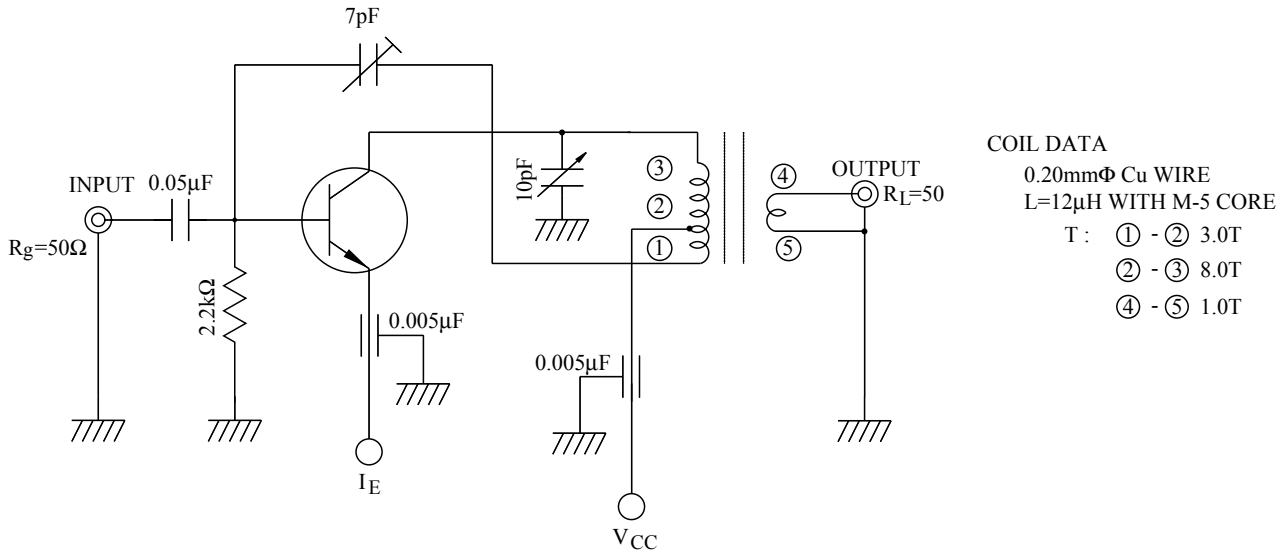

STATIC CHARACTERISTICS

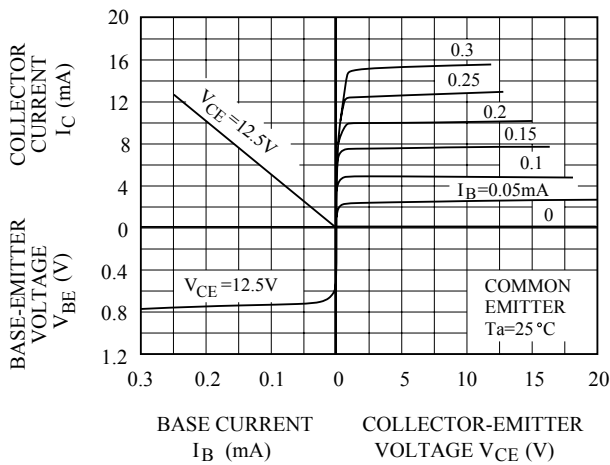

$I_C - V_{CE}$

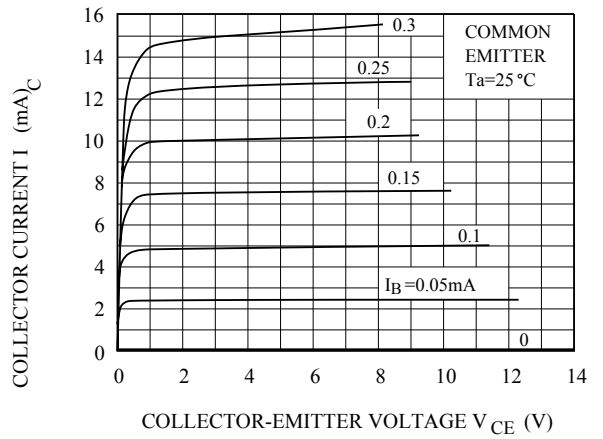

$G_{pe} - I_E$ (See Fig 1)

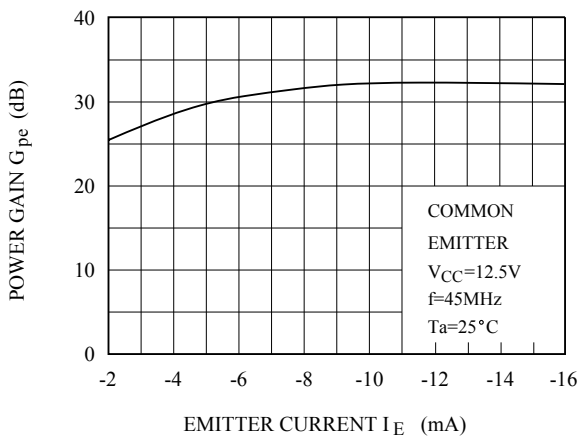

$h_{FE} - I_C$

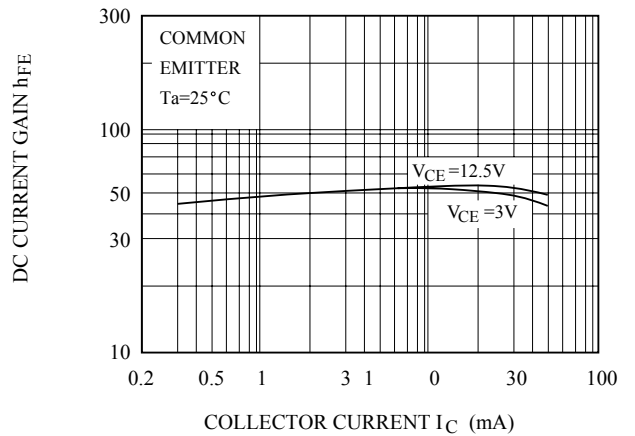

$f_T - I_C$

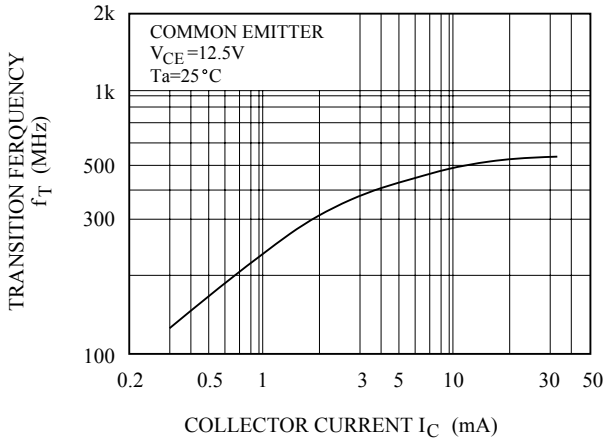

$C_{ob} - V_{CB}$

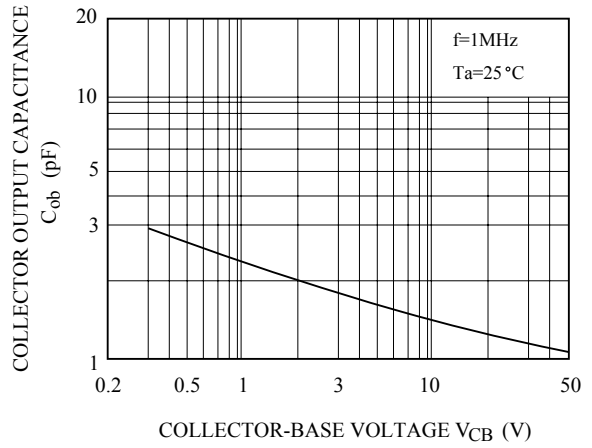

$g_{oe}, C_{oe} - I_C$

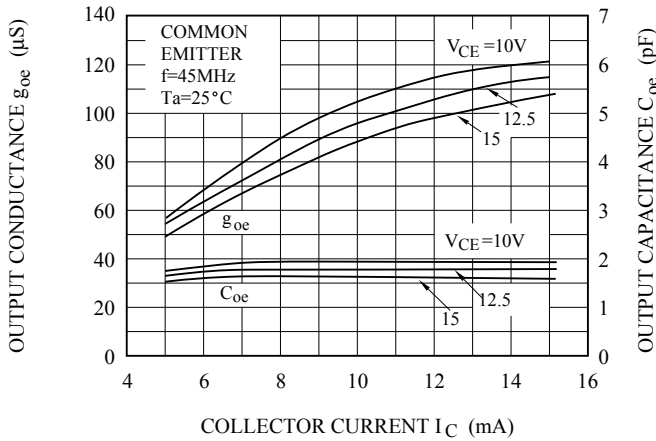

$g_{oe}, C_{oe} - I_C$

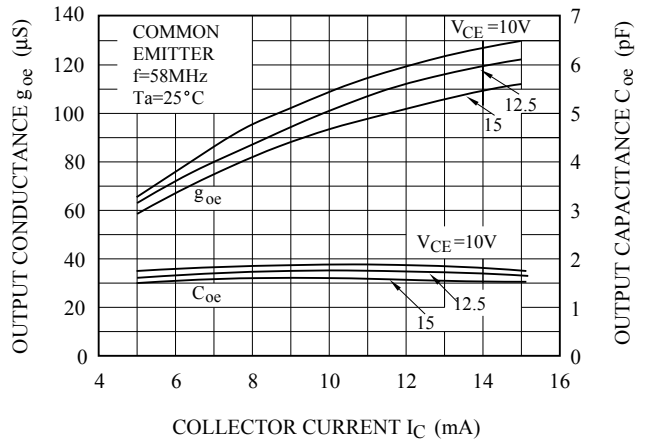

$g_{ie}, C_{ie} - I_C$

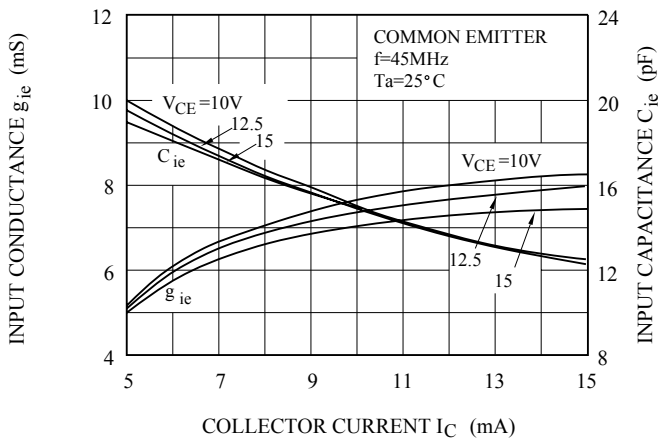

$g_{ie}, C_{ie} - I_C$

