

# GT60M303

## HIGH POWER SWITCHING APPLICATIONS

- The 4th Generation
- FRD Included Between Emitter and Collector
- Enhancement-Mode
- High Speed IGBT :  $t_f = 0.25\mu s$  (TYP.)  
FRD :  $t_{rr} = 0.7\mu s$  (TYP.)
- Low Saturation Voltage :  $V_{CE(sat)} = 2.1V$  (TYP.)

## MAXIMUM RATINGS (Ta = 25°C)

CHARACTERISTIC		SYMBOL	RATING	UNIT
Collector-Emitter Voltage		$V_{CES}$	900	V
Gate-Emitter Voltage		$V_{GES}$	$\pm 25$	V
Collector Current	DC	$I_C$	60	A
	1ms	$I_{CP}$	120	
Emitter-Collector Forward Current	DC	$I_{ECF}$	15	A
	1ms	$I_{ECFP}$	120	
Collector Power Dissipation (Tc = 25°C)		$P_C$	170	W
Junction Temperature		$T_j$	150	°C
Storage Temperature Range		$T_{stg}$	-55~150	°C
Screw Torque		—	0.8	N·m

Unit: mm

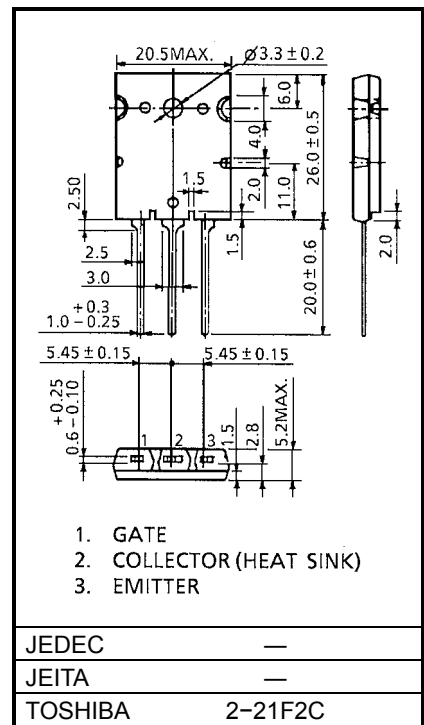

JEDEC	—
JEITA	—
TOSHIBA	2-21F2C

Weight : 9.75g

## EQUIVALENT CIRCUIT

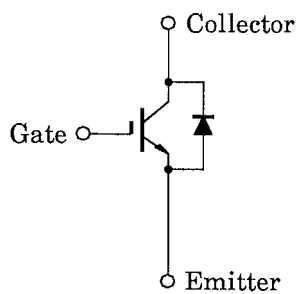

## ELECTRICAL CHARACTERISTICS (Ta = 25°C)

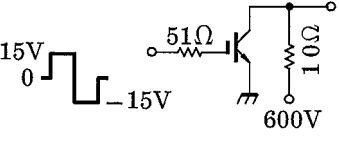
CHARACTERISTIC		SYMBOL	TEST CONDITION	MIN	TYP.	MAX	UNIT
Gate Leakage Current		$I_{GES}$	$V_{GE} = \pm 25V, V_{CE} = 0$	—	—	±500	nA
Collector Cut-off Current		$I_{CES}$	$V_{CE} = 900V, V_{GE} = 0$	—	—	1.0	mA
Gate-Emitter Cut-off Voltage		$V_{GE (OFF)}$	$I_C = 60mA, V_{CE} = 5V$	3.0	—	6.0	V
Collector-Emitter Saturation Voltage		$V_{CE (sat) (1)}$	$I_C = 10A, V_{GE} = 15V$	—	1.6	2.2	V
Collector-Emitter Saturation Voltage		$V_{CE (sat) (2)}$	$I_C = 60A, V_{GE} = 15V$	—	2.1	2.7	V
Input Capacitance		$C_{ies}$	$V_{CE} = 10V, V_{GE} = 0, f = 1MHz$	—	3800	—	pF
Switching Time	Rise Time	$t_r$		—	0.35	0.60	μs
	Turn-On Time	$t_{on}$		—	0.46	0.75	
	Fall Time	$t_f$		—	0.25	0.40	
	Turn-Off Time	$t_{off}$		—	0.60	0.70	
Emitter-Collector Forward Voltage		$V_{ECF}$	$I_{EC} = 15A, V_{GE} = 0$	—	1.5	2.0	V
Reverse Recovery Time		$t_{rr}$	$I_F = 15A, V_{GE} = 0$ $di / dt = -20A / \mu s$	—	0.7	2.5	μs
Thermal Resistance		$R_{th (j-c)}$	IGBT	—	—	0.74	°C / W
Thermal Resistance		$R_{th (j-c)}$	Diode	—	—	4.0	°C / W

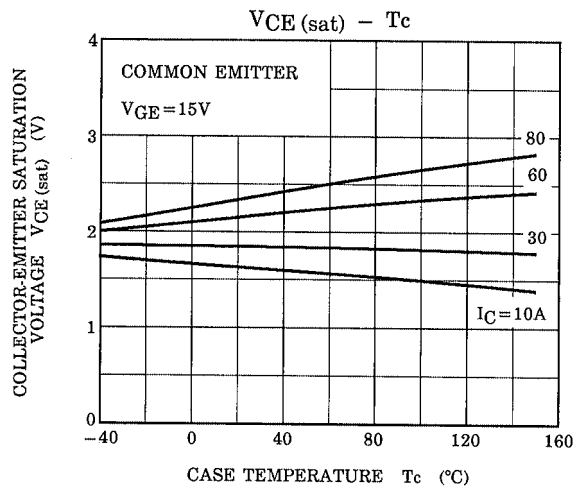
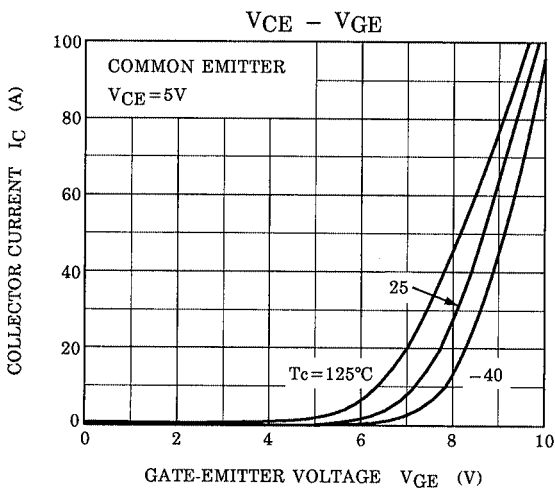
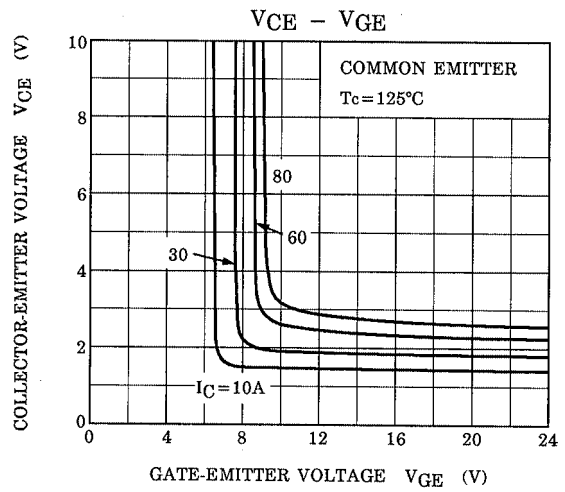
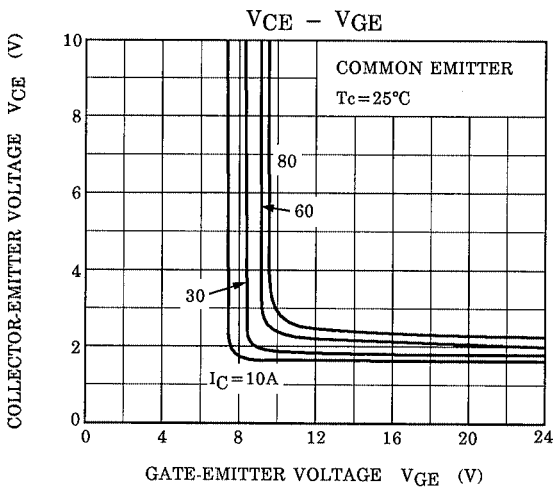
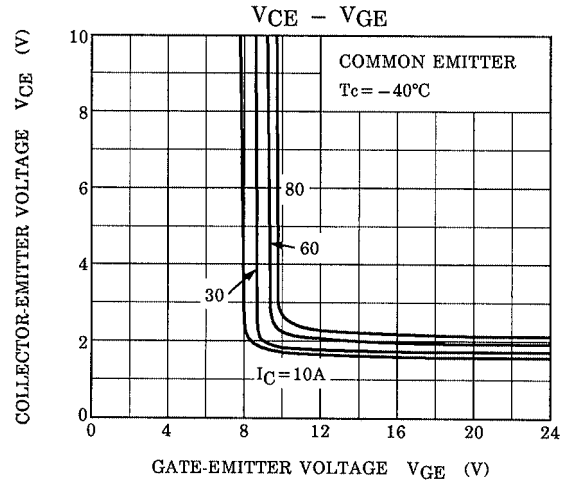
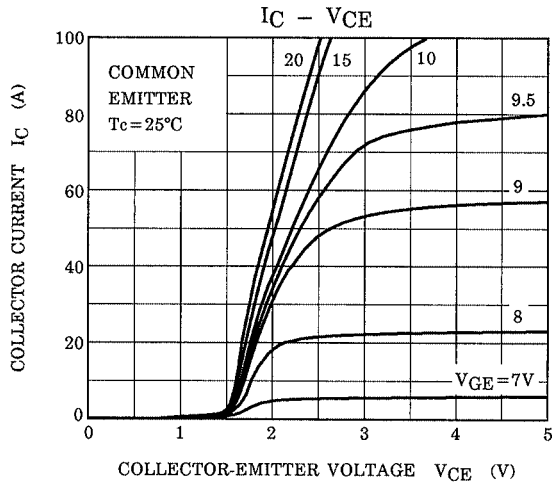

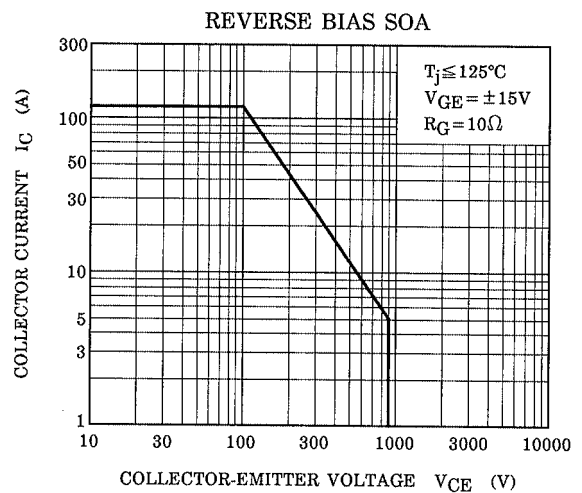
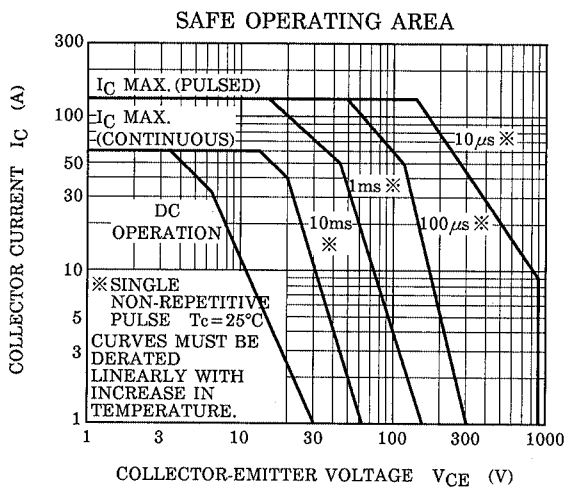
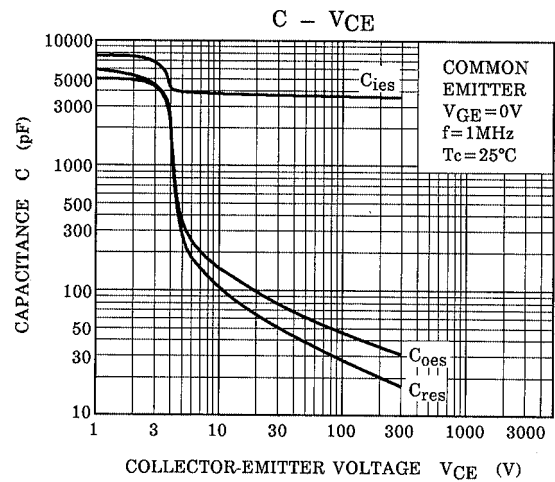
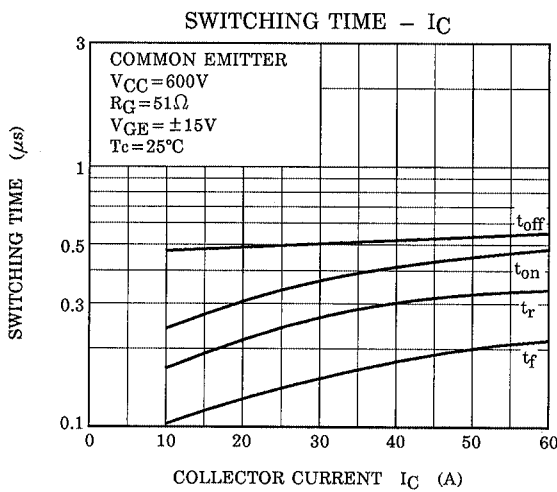
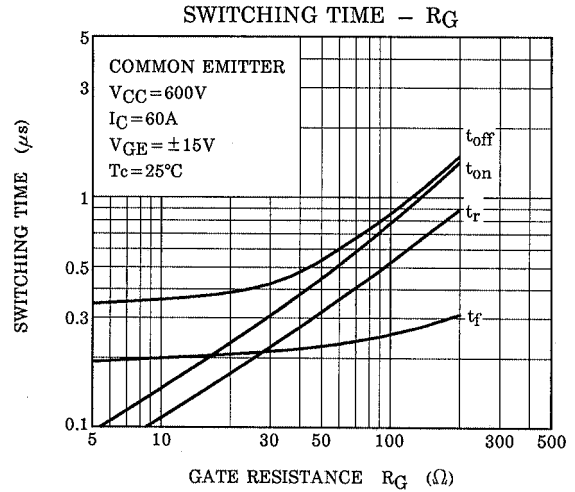
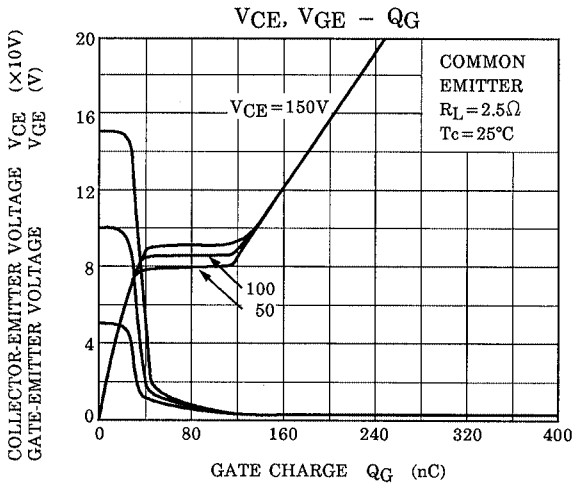

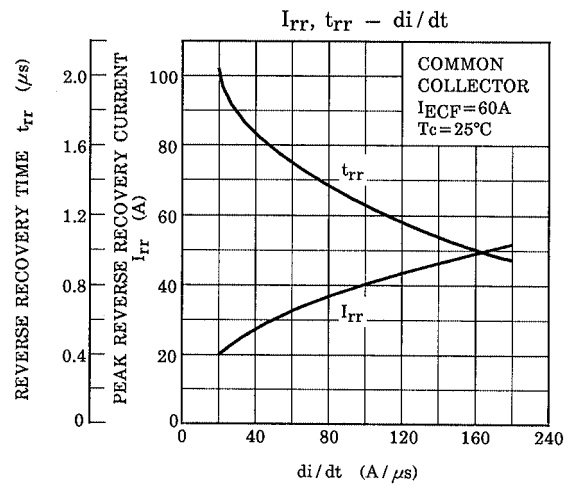
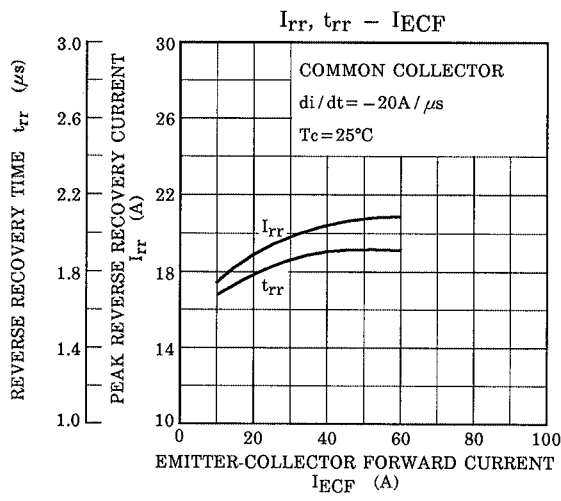
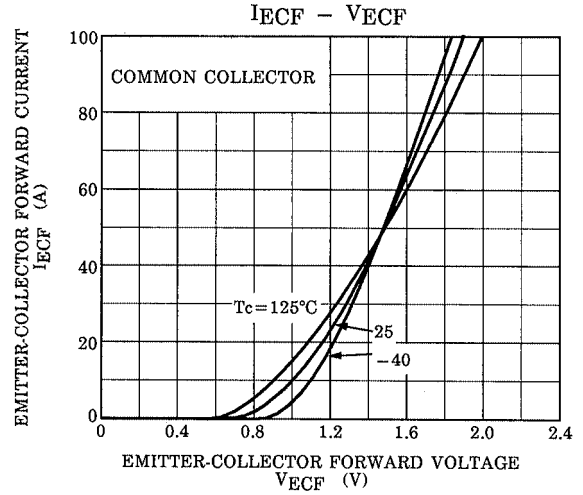
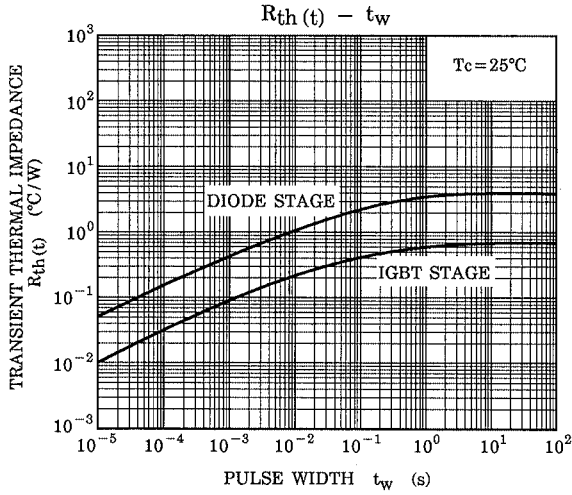

**RESTRICTIONS ON PRODUCT USE**

000707EAA

- TOSHIBA is continually working to improve the quality and reliability of its products. Nevertheless, semiconductor devices in general can malfunction or fail due to their inherent electrical sensitivity and vulnerability to physical stress. It is the responsibility of the buyer, when utilizing TOSHIBA products, to comply with the standards of safety in making a safe design for the entire system, and to avoid situations in which a malfunction or failure of such TOSHIBA products could cause loss of human life, bodily injury or damage to property.  
In developing your designs, please ensure that TOSHIBA products are used within specified operating ranges as set forth in the most recent TOSHIBA products specifications. Also, please keep in mind the precautions and conditions set forth in the "Handling Guide for Semiconductor Devices," or "TOSHIBA Semiconductor Reliability Handbook" etc..
- The TOSHIBA products listed in this document are intended for usage in general electronics applications (computer, personal equipment, office equipment, measuring equipment, industrial robotics, domestic appliances, etc.). These TOSHIBA products are neither intended nor warranted for usage in equipment that requires extraordinarily high quality and/or reliability or a malfunction or failure of which may cause loss of human life or bodily injury ("Unintended Usage"). Unintended Usage include atomic energy control instruments, airplane or spaceship instruments, transportation instruments, traffic signal instruments, combustion control instruments, medical instruments, all types of safety devices, etc.. Unintended Usage of TOSHIBA products listed in this document shall be made at the customer's own risk.
- The information contained herein is presented only as a guide for the applications of our products. No responsibility is assumed by TOSHIBA CORPORATION for any infringements of intellectual property or other rights of the third parties which may result from its use. No license is granted by implication or otherwise under any intellectual property or other rights of TOSHIBA CORPORATION or others.
- The information contained herein is subject to change without notice.