

TOSHIBA Transistor Silicon PNP Epitaxial Type (PCT Process)

RN2001,RN2002,RN2003 RN2004,RN2005,RN2006

Switching, Inverter Circuit, Interface Circuit
And Driver Circuit Applications

- With built-in bias resistors
- Simplify circuit design
- Reduce a quantity of parts and manufacturing process
- Complementary to RN1001~RN1006

Equivalent Circuit and Bias Resister Values

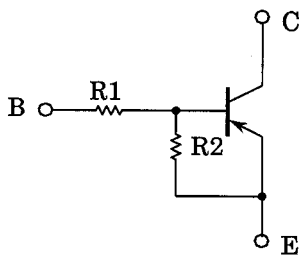

Type No.	R1 (kΩ)	R2 (kΩ)
RN2001	4.7	4.7
RN2002	10	10
RN2003	22	22
RN2004	47	47
RN2005	2.2	47
RN2006	4.7	47

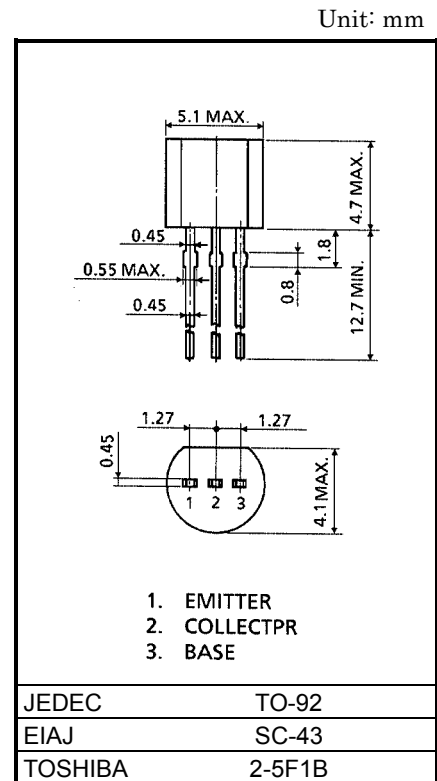

Weight: 0.21g

Maximum Ratings (Ta = 25°C)

Characteristic	Symbol	Rating	Unit	
Collector-base voltage	RN2001~2006	V_{CBO}	-50	V
Collector-emitter voltage		V_{CEO}	-50	V
Emitter-base voltage	RN2001~2004	V_{EBO}	-10	V
	RN2005, 2006		-5	
Collector current	RN2001~2006	I_C	-100	mA
Collector power dissipation		P_C	400	mW
Junction temperature		T_j	150	°C
Storage temperature range		T_{stg}	-55~150	°C

Electrical Characteristics (Ta = 25°C)

Characteristic		Symbol	Test Circuit	Test Condition	Min	Typ.	Max	Unit
Collector cut-off current	RN2001~2006	I_{CBO}	—	$V_{CB} = -50V, I_E = 0$	—	—	-100	nA
		I_{CEO}	—	$V_{CE} = -50V, I_B = 0$	—	—	-500	
Emitter cut-off current	RN2001	I_{EBO}	—	$V_{EB} = -10V, I_C = 0$	-0.82	—	-1.52	mA
	RN2002				-0.38	—	-0.71	
	RN2003				-0.17	—	-0.33	
	RN2004				-0.082	—	-0.15	
	RN2005			$V_{EB} = -5V, I_C = 0$	-0.078	—	-0.145	
	RN2006				-0.074	—	-0.138	
DC current gain	RN2001	h_{FE}	—	$V_{CE} = -5V, I_C = -10mA$	30	—	—	
	RN2002				50	—	—	
	RN2003				70	—	—	
	RN2004				80	—	—	
	RN2005				80	—	—	
	RN2006				80	—	—	
Collector-emitter saturation voltage	RN2001~2006	$V_{CE(sat)}$	—	$I_C = -5mA, I_B = -0.25mA$	—	-0.1	-0.3	V
Input voltage (ON)	RN2001	$V_{I(ON)}$	—	$V_{CE} = -0.2V, I_C = -5mA$	-1.1	—	-2.0	V
	RN2002				-1.2	—	-2.4	
	RN2003				-1.3	—	-3.0	
	RN2004				-1.5	—	-5.0	
	RN2005				-0.6	—	-1.1	
	RN2006				-0.7	—	-1.3	
Input voltage (OFF)	RN2001~2004	$V_{I(OFF)}$	—	$V_{CE} = -5V, I_C = -0.1mA$	-1.0	—	-1.5	V
	RN2005, 2006				-0.5	—	-0.8	
Transition frequency	RN2001~2006	f_T	—	$V_{CE} = -10V, I_C = -5mA$	—	200	—	MHz
Collector Output capacitance	RN2001~2006	C_{ob}	—	$V_{CB} = -10V, I_E = 0, f = 1MHz$	—	3	6	pF
Input resistor	RN2001	R1	—		3.29	4.7	6.11	kΩ
	RN2002				7	10	13	
	RN2003				15.4	22	28.6	
	RN2004				32.9	47	61.1	
	RN2005				1.54	2.2	2.86	
	RN2006				3.29	4.7	6.11	
Resistor ratio	RN2001~2004	R1/R2	—		0.9	1.0	1.1	
	RN2005				0.0421	0.0468	0.0515	
	RN2006				0.09	0.1	0.11	

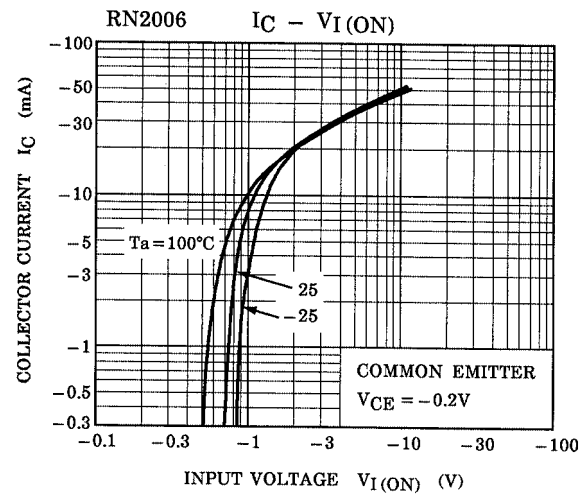
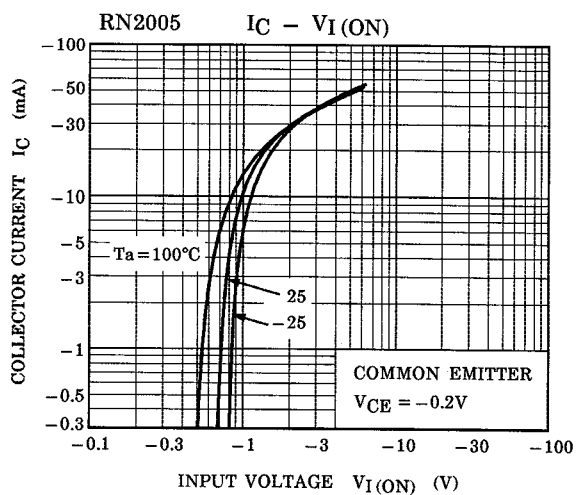
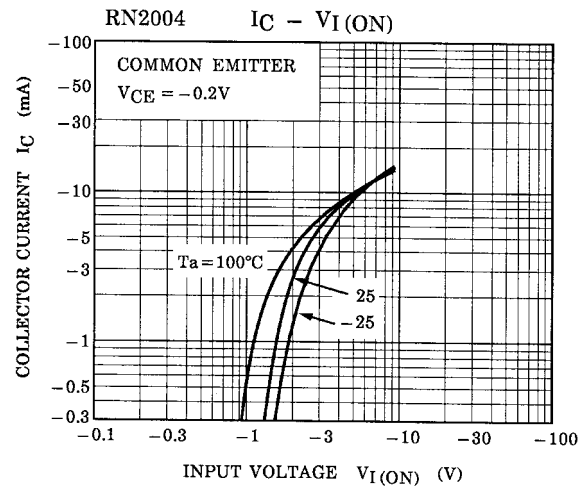
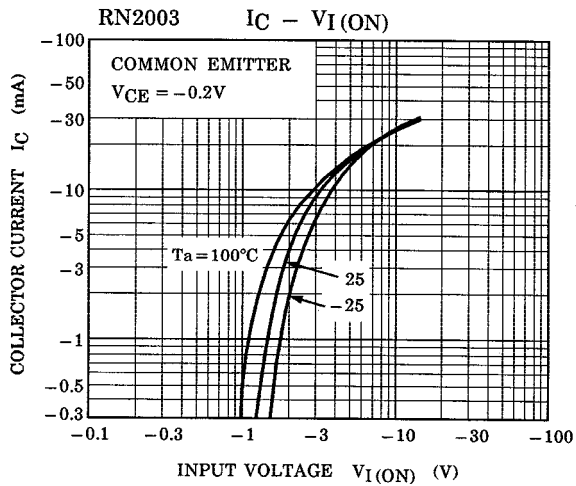
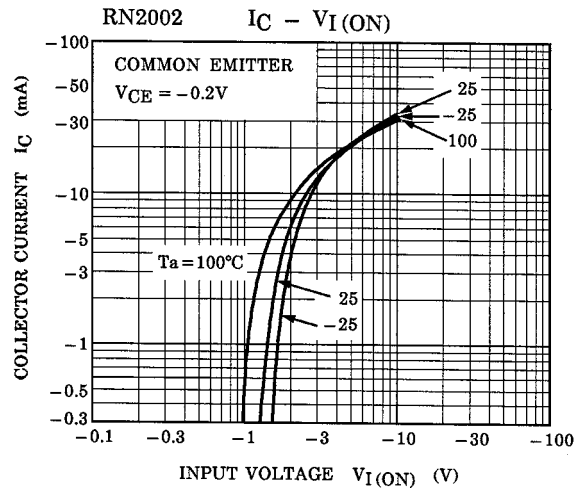
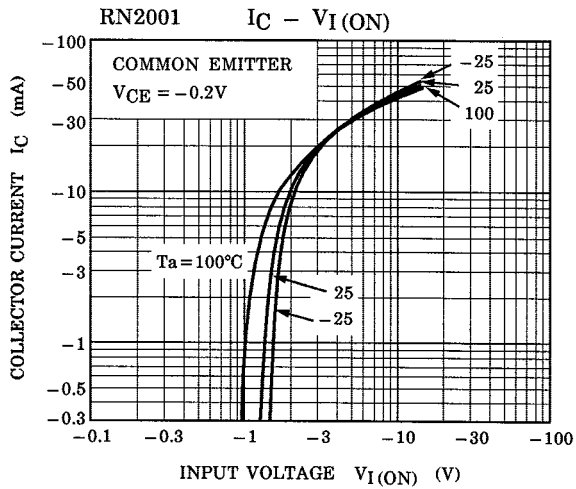

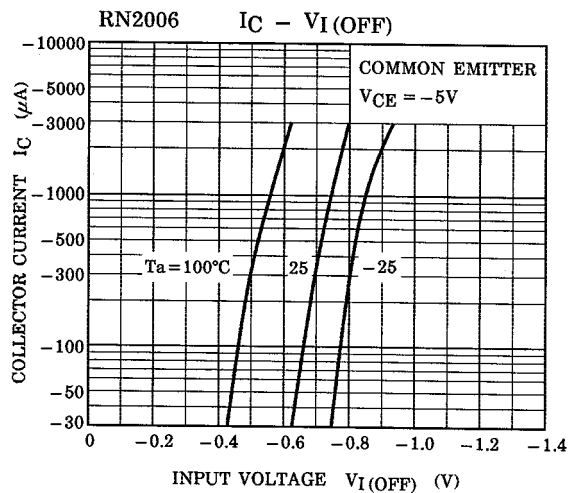
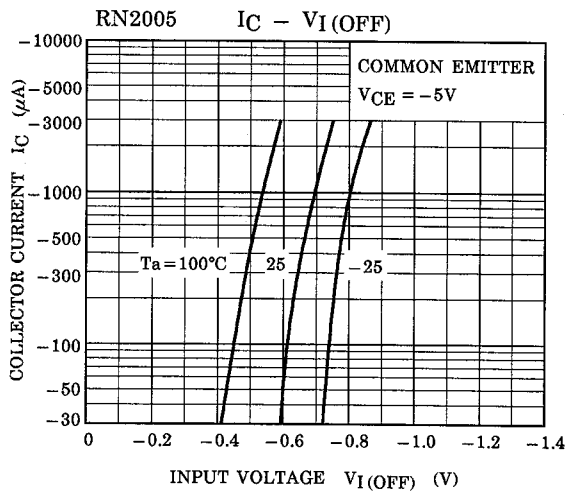
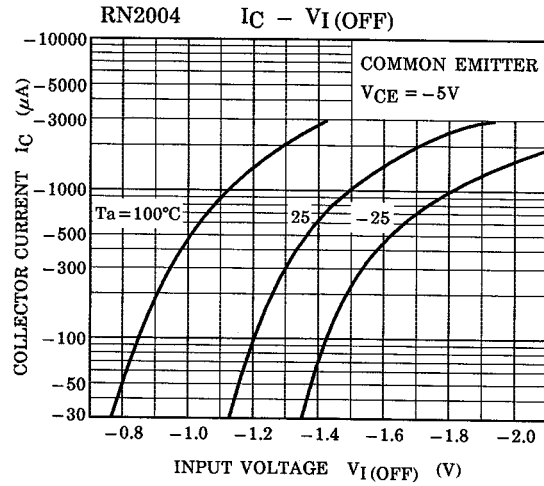
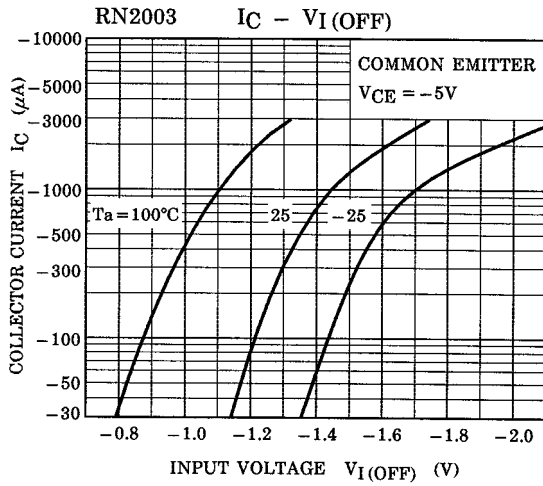
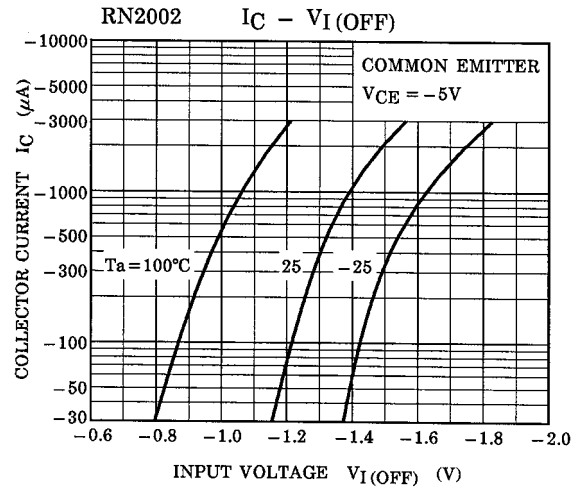
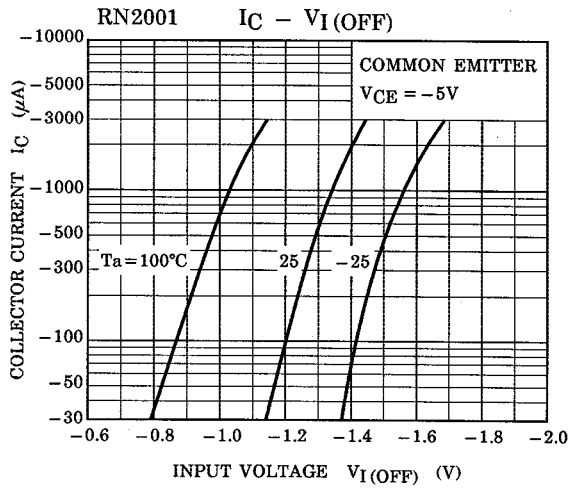

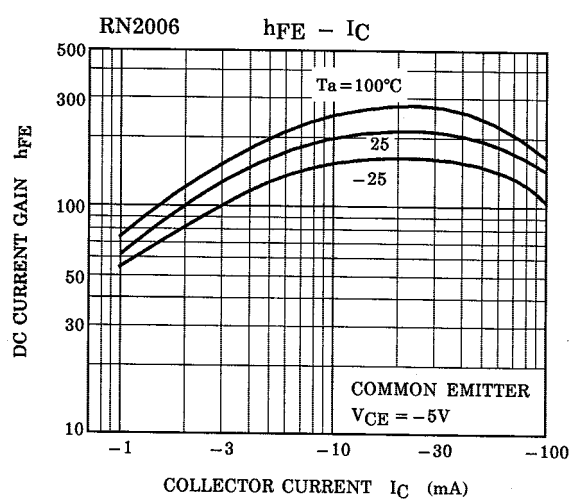
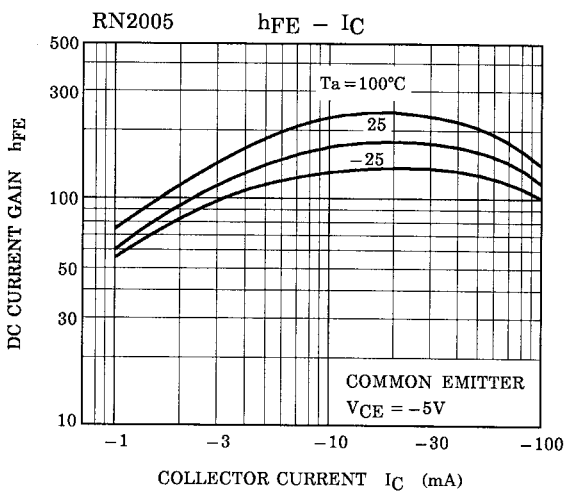
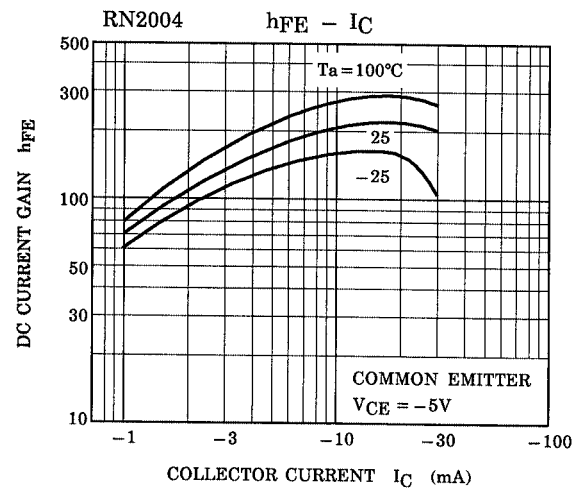
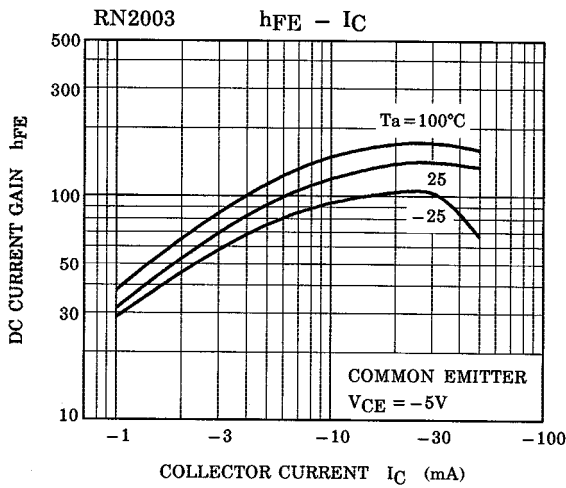
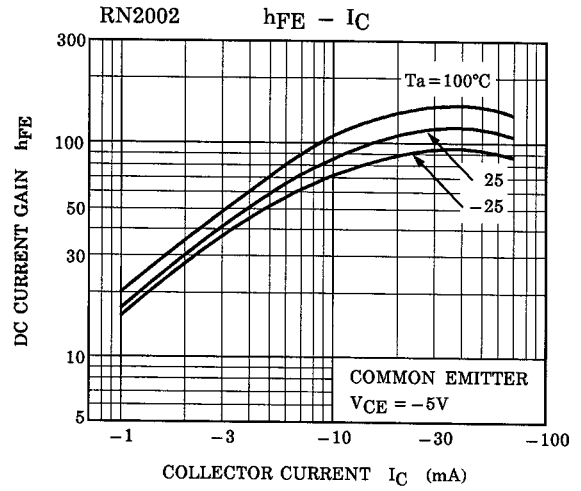
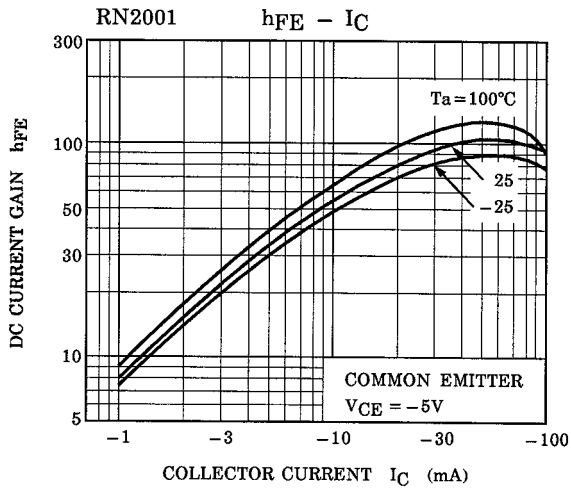

RESTRICTIONS ON PRODUCT USE

000707EAA

- TOSHIBA is continually working to improve the quality and reliability of its products. Nevertheless, semiconductor devices in general can malfunction or fail due to their inherent electrical sensitivity and vulnerability to physical stress. It is the responsibility of the buyer, when utilizing TOSHIBA products, to comply with the standards of safety in making a safe design for the entire system, and to avoid situations in which a malfunction or failure of such TOSHIBA products could cause loss of human life, bodily injury or damage to property.
In developing your designs, please ensure that TOSHIBA products are used within specified operating ranges as set forth in the most recent TOSHIBA products specifications. Also, please keep in mind the precautions and conditions set forth in the "Handling Guide for Semiconductor Devices," or "TOSHIBA Semiconductor Reliability Handbook" etc..
- The TOSHIBA products listed in this document are intended for usage in general electronics applications (computer, personal equipment, office equipment, measuring equipment, industrial robotics, domestic appliances, etc.). These TOSHIBA products are neither intended nor warranted for usage in equipment that requires extraordinarily high quality and/or reliability or a malfunction or failure of which may cause loss of human life or bodily injury ("Unintended Usage"). Unintended Usage include atomic energy control instruments, airplane or spaceship instruments, transportation instruments, traffic signal instruments, combustion control instruments, medical instruments, all types of safety devices, etc.. Unintended Usage of TOSHIBA products listed in this document shall be made at the customer's own risk.
- The information contained herein is presented only as a guide for the applications of our products. No responsibility is assumed by TOSHIBA CORPORATION for any infringements of intellectual property or other rights of the third parties which may result from its use. No license is granted by implication or otherwise under any intellectual property or other rights of TOSHIBA CORPORATION or others.
- The information contained herein is subject to change without notice.