

TOSHIBA MOS DIGITAL INTEGRATED CIRCUIT SILICON GATE CMOS

65,536-WORD BY 16-BIT CMOS STATIC RAM

DESCRIPTION

The TC551664AJ is a 1,048,576-bit high-speed static random access memory (SRAM) organized as 65,536 words by 16 bits. Fabricated using CMOS technology and advanced circuit techniques to provide high speed, it operates from a single 5 V power supply. Chip enable (\overline{CE}) can be used to place the device in a low-power mode, and output enable (\overline{OE}) provides fast memory access. Data byte control signals (\overline{LB} , \overline{UB}) provide lower and upper byte access. This device is well suited to cache memory applications where high-speed access and high-speed storage are required. All inputs and outputs are directly TTL compatible. The TC551664AJ is available in a plastic 44-pin SOJ package (400 mil width) for high density surface assembly.

FEATURES

- Fast access time (the following are maximum values)
 - TC551664AJ-15: 15 ns
 - TC551664AJ-20: 20 ns
- Low-power dissipation (the following are maximum values)
- Single power supply voltage of 5 V \pm 10%
- Fully static operation
- All inputs and outputs are TTL compatible
- Output buffer control using \overline{OE}
- Data byte control using \overline{LB} (IO1 to IO8) and \overline{UB} (IO9 to IO16)
- Package: SOJ44-P-400-1.27 (Weight: 1.64 g typ)

Cycle Time	15	20	25	30	50	ns
Operation (max)	260	220	200	180	150	mA

Standby: 1 mA (both devices)

PIN ASSIGNMENT

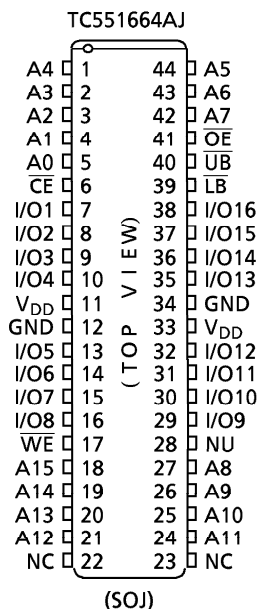

PIN NAMES

A0 to A15	Address Inputs
I/O1 to I/O16	Data Inputs/Outputs
\overline{CE}	Chip Enable
\overline{WE}	Write Enable Input
\overline{OE}	Output Enable
\overline{LB} , \overline{UB}	Data Byte Control Input
V_{DD}	Power (+ 5 V)
GND	Ground
NC	No Connection
NU	Not Used (Input)

961001EBA1

- TOSHIBA is continually working to improve the quality and the reliability of its products. Nevertheless, semiconductor devices in general can malfunction or fail due to their inherent electrical sensitivity and vulnerability to physical stress. It is the responsibility of the buyer, when utilizing TOSHIBA products, to observe standards of safety, and to avoid situations in which a malfunction or failure of a TOSHIBA product could cause loss of human life, bodily injury or damage to property. In developing your designs, please ensure that TOSHIBA products are used within specified operating ranges as set forth in the most recent products specifications. Also, please keep in mind the precautions and conditions set forth in the TOSHIBA Semiconductor Reliability Handbook.
- The products described in this document are subject to foreign exchange and foreign trade control laws.
- The information contained herein is presented only as a guide for the applications of our products. No responsibility is assumed by TOSHIBA CORPORATION for any infringements of intellectual property or other rights of the third parties which may result from its use. No license is granted by implication or otherwise under any intellectual property or other rights of TOSHIBA CORPORATION or others.
- The information contained herein is subject to change without notice.

BLOCK DIAGRAM

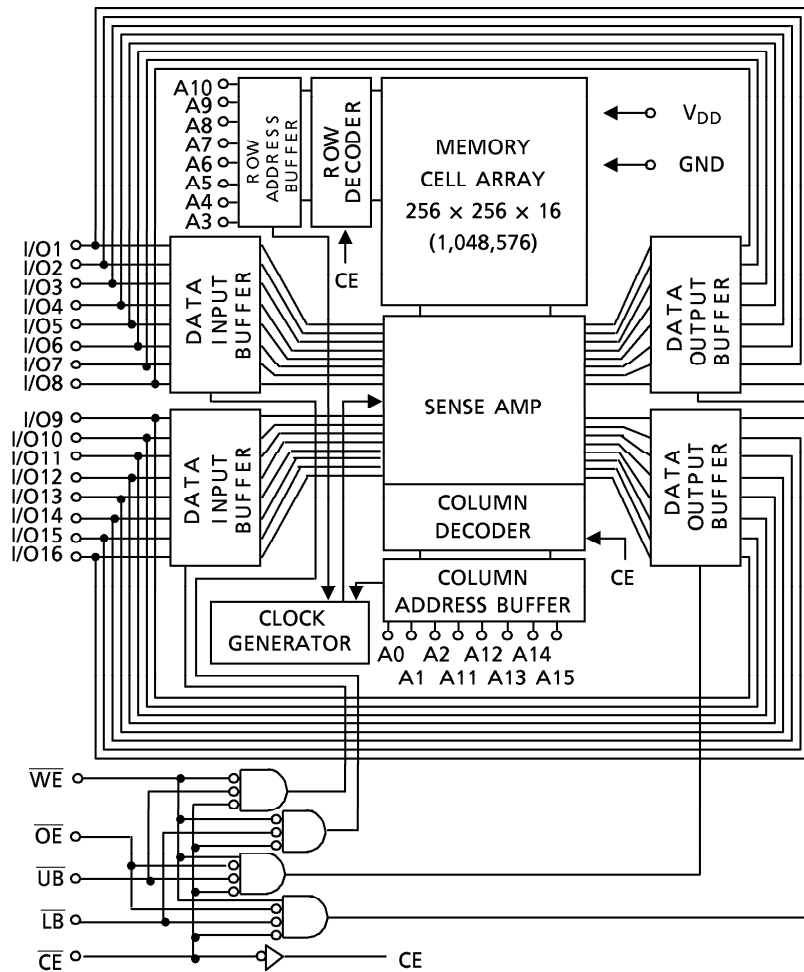

MAXIMUM RATINGS

SYMBOL	RATING	VALUE	UNIT
V_{DD}	Power Supply Voltage	- 0.5 to 7.0	V
V_{IN}	Input Terminal Voltage	- 2.0 * to 7.0	V
$V_{I/O}$	Input/Output Terminal Voltage	- 0.5 * to $V_{DD} + 0.5$	V
P_D	Power Dissipation	1.5	W
T_{solder}	Soldering Temperature (10 s)	260	°C
T_{strg}	Storage Temperature	- 65 to 150	°C
T_{opr}	Operating Temperature	- 10 to 85	°C

*: - 3 V with a pulse width of 10 ns

DC RECOMMENDED OPERATING CONDITIONS ($T_a = 0^\circ$ to 70°C)

SYMBOL	PARAMETER	MIN	TYP	MAX	UNIT
V_{DD}	Power Supply Voltage	4.5	5.0	5.5	V
V_{IH}	Input High Voltage	2.2	-	$V_{DD} + 0.5$	V
V_{IL}	Input Low Voltage	- 0.5 *	-	0.8	V

*: - 3 V with a pulse width of 10 ns

DC CHARACTERISTICS (Ta = 0° to 70°C, VDD = 5 V ± 10%)

SYMBOL	PARAMETER	TEST CONDITION	MIN	TYP	MAX	UNIT	
I _{IL}	Input Leakage Current (Except NU Pin)	V _{IN} = 0 V to V _{DD}	-	-	± 10	μA	
I _{LO}	Output Leakage Current	$\overline{CE} = V_{IH}$ or $\overline{WE} = V_{IL}$ or $\overline{OE} = V_{IH}$ V _{OUT} = 0 V to V _{DD}	-	-	± 10	μA	
I _{I(NU)}	Input Current (NU Pin)	V _{IN} = 0 to 0.8 V	- 1	-	20	μA	
I _{OH}	Output High Current	V _{OH} = 2.4 V	- 4	-	-	mA	
I _{OL}	Output Low Current	V _{OL} = 0.4 V	8	-	-	mA	
I _{DDO}	Operating Current	$\overline{CE} = V_{IL}$, I _{out} = 0 mA Other Inputs = V _{IH} or V _{IL}	tcycle = 15 ns	-	-	260	mA
			tcycle = 20 ns	-	-	220	
			tcycle = 25 ns	-	-	200	
			tcycle = 30 ns	-	-	180	
			tcycle = 50 ns	-	-	150	
I _{DDS 1}	Standby Current	$\overline{CE} = V_{IH}$, Other Inputs = V _{IH} or V _{IL}	-	-	30	mA	
I _{DDS 2}		$\overline{CE} = V_{DD} - 0.2 V$ Other Inputs = V _{DD} - 0.2 V or 0.2 V	-	-	1		

CAPACITANCE (Ta = 25°C, f = 1.0 MHz)

SYMBOL	PARAMETER	TEST CONDITION	MAX	UNIT
C _{IN}	Input Capacitance	V _{IN} = GND	6	pF
C _{I/O}	Input/Output Capacitance	V _{I/O} = GND	8	pF

Note: This parameter is periodically sampled and is not 100% tested.

OPERATING MODE

MODE	\overline{CE}	\overline{OE}	\overline{WE}	\overline{LB}	\overline{UB}	I/O1 to I/O8	I/O9 to I/O16	POWER
Read	L	L	H	L	L	Output	Output	I _{DDO}
				H	L	High Impedance	Output	I _{DDO}
				L	H	Output	High Impedance	I _{DDO}
Write	L	x	L	L	L	Input	Input	I _{DDO}
				H	L	High Impedance	Input	I _{DDO}
				L	H	Input	High Impedance	I _{DDO}
Outputs Disable	L	H	H	x	x	High Impedance	High Impedance	I _{DDO}
	L	x	x	H	H			
Standby	H	x	x	x	x	High Impedance	High Impedance	I _{DDS}

x: Don't care

Note: The NU pin must be left unconnected or tied to GND or a voltage level of less than 0.8 V. You must not apply a voltage of more than 0.8 V to the NU.

AC CHARACTERISTICS (Ta = 0° to 70°C (Note 1), VDD = 5 V ± 10%)

READ CYCLE

SYMBOL	PARAMETER	TC551664AJ-15		TC551664AJ-20		UNIT
		MIN	MAX	MIN	MAX	
t _{RC}	Read Cycle Time	15	–	20	–	ns
t _{ACC}	Address Access Time	–	15	–	20	
t _{CO}	Chip Enable Access Time	–	15	–	20	
t _{OE}	Output Enable Access Time	–	8	–	10	
t _{BA}	Upper Byte, Lower Byte Access Time	–	8	–	10	
t _{OH}	Output Data Hold Time from Address Change	5	–	5	–	
t _{COE}	Output Enable Time from Chip Enable	5	–	5	–	
t _{OEE}	Output Enable Time from Output Enable	1	–	1	–	
t _{BE}	Output Enable Time from Upper Byte, Lower Byte	1	–	1	–	
t _{COD}	Output Disable Time from Chip Enable	–	8	–	8	
t _{ODO}	Output Disable Time from Output Enable	–	8	–	8	
t _{BD}	Output Disable Time from Upper Byte, Lower Byte	–	8	–	8	

WRITE CYCLE

SYMBOL	PARAMETER	TC551664AJ-15		TC551664AJ-20		UNIT
		MIN	MAX	MIN	MAX	
t _{WC}	Write Cycle Time	15	–	20	–	ns
t _{WP}	Write Pulse Width	9	–	10	–	
t _{CW}	Chip Enable to End of Write	12	–	13	–	
t _{BW}	Upper Byte, Lower Byte Enable to End of Write	12	–	12	–	
t _{AW}	Address Valid to End of Write	12	–	12	–	
t _{AS}	Address Setup Time	0	–	0	–	
t _{WR}	Write Recovery Time	0	–	0	–	
t _{DS}	Data Setup Time	8	–	10	–	
t _{DH}	Data Hold Time	0	–	0	–	
t _{OEW}	Output Enable Time from Write Enable	1	–	1	–	
t _{ODW}	Output Disable Time from Write Enable	–	8	–	8	

AC TEST CONDITIONS

Input Pulse Level	3.0 V, 0.0 V
Input Pulse Rise and Fall Time	3 ns
Input Timing Measurement Reference Level	1.5 V
Output Timing Measurement Reference Level	1.5 V
Output Load	Fig. 1

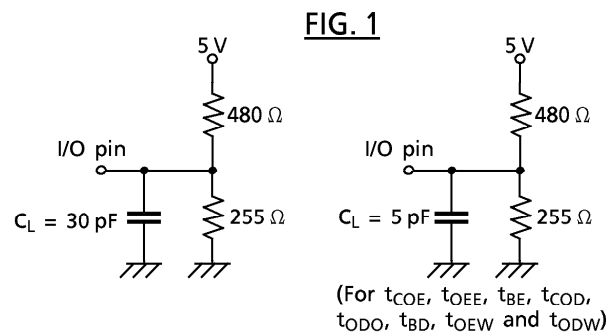

WRITE CYCLE 2 (\overline{CE} CONTROLLED) (See Note 5)

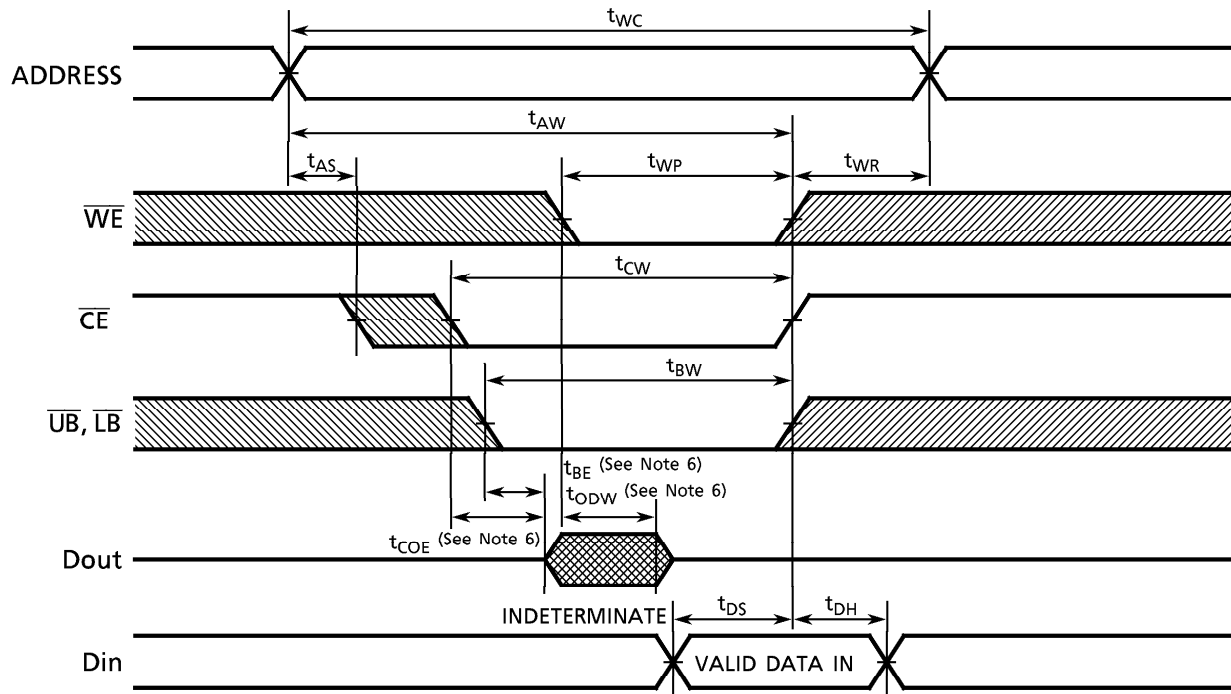

WRITE CYCLE 3 ($\overline{UB}, \overline{LB}$ CONTROLLED) (See Note 5)

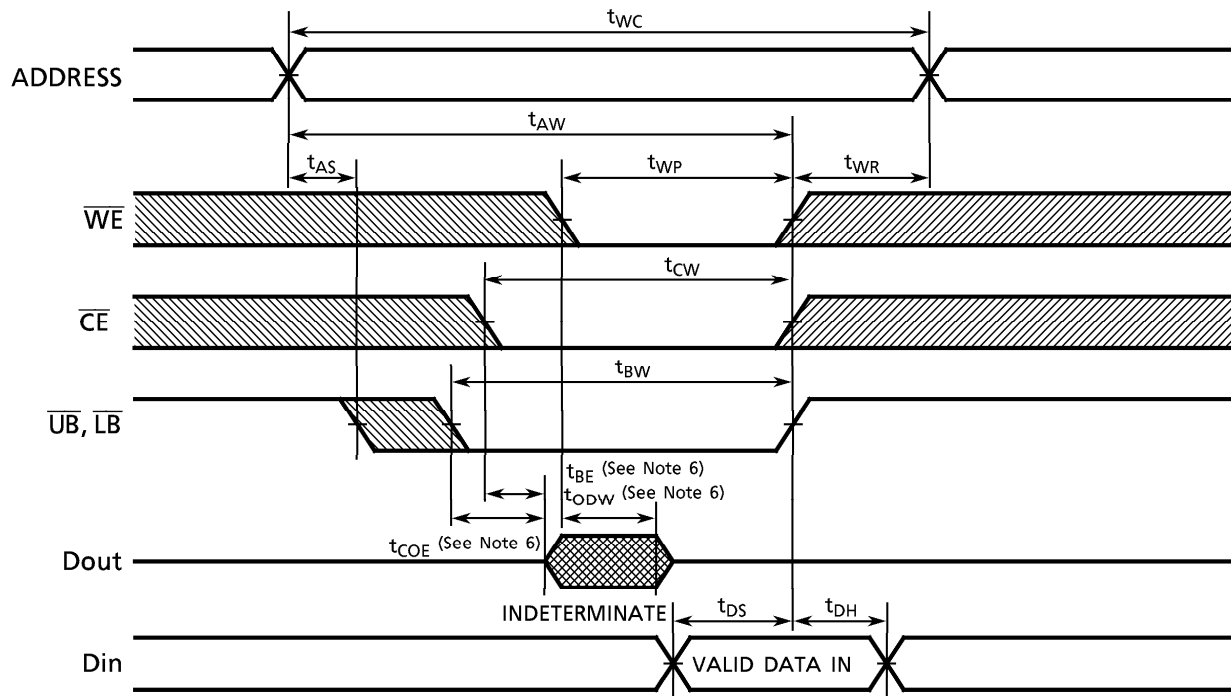

Note: (1) Operating temperature (Ta) is guaranteed for transverse air flow exceeding 400 linear feet per minute.

(2) \overline{WE} remains HIGH for the Read Cycle.

(3) If \overline{CE} goes LOW coincident with or after \overline{WE} goes LOW, the outputs will remain at high impedance.

(4) If \overline{CE} goes HIGH coincident with or before \overline{WE} goes HIGH, the outputs will remain at high impedance.

(5) If \overline{OE} is HIGH during the write cycle, the outputs will remain at high impedance.

(6) The parameters specified below are measured using the load shown in Fig. 1.

(A) $t_{COE}, t_{OEE}, t_{BE}, t_{OEw}$ ····· Output Enable Time

(B) $t_{COD}, t_{ODO}, t_{BD}, t_{ODw}$ ····· Output Disable Time

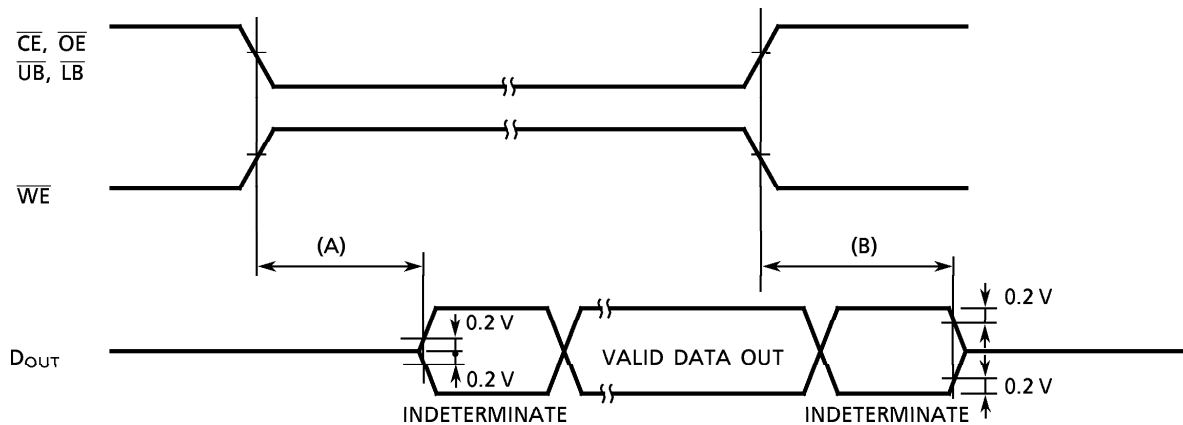

PACKAGE DIMENSIONS

Plastic SOJ (SOJ44-P-400-1.27)

Units in mm

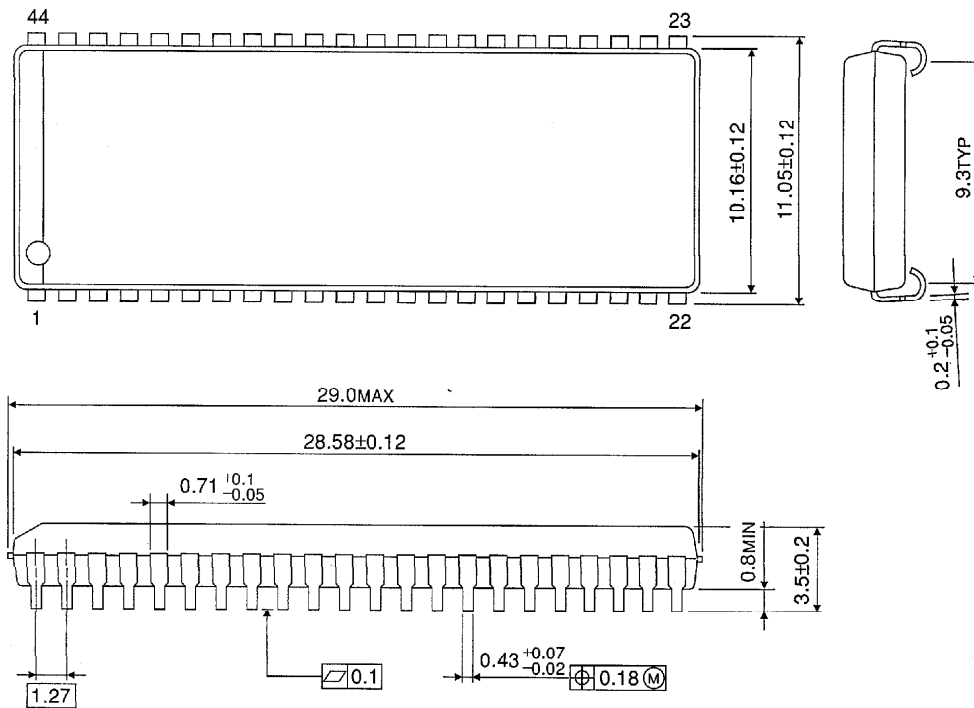

Weight: 1.64 g (typ)