

TOSHIBA LED LAMP GaP GREEN LIGHT EMISSION

TLGD245P

PANEL CIRCUIT INDICATOR

Unit in mm

- 5mm DIAMETER (T1-3 / 4) FRANGELESS PACKAGE
- All Plastic Mold Type Colorless Clear Lens
- Low Drive Current, High Intensity Green Light Emission.
Recommended Forward Current : $I_F = 15 \sim 20 \text{mA}$ (DC)
- All Plastic Molded Lens, Provides an Excellent ON-OFF Contrast Ratio.
- Fast Response Time, Capable of Pulse Operation.
- High Power Luminous Intensity Suitable for Outdoor Message Signboards.
- Without stand-offs

MAXIMUM RATINGS ($T_a = 25^\circ\text{C}$)

CHARACTERISTIC	SYMBOL	RATING	UNIT
Forward Current (DC)	I_F	40	mA
Reverse Voltage	V_R	4	V
Power Dissipation	P_D	120	mW
Operating Temperature Range	T_{opr}	-20~85	°C
Storage Temperature Range	T_{stg}	-30~100	°C

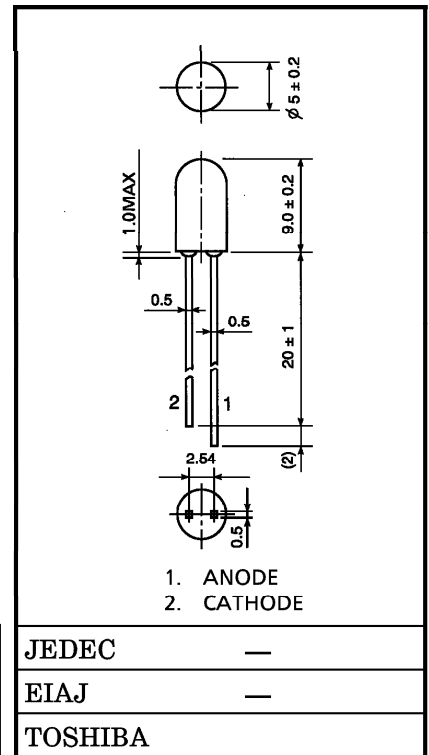

Weight : 0.31g

ELECTRO-OPTICAL CHARACTERISTICS (Ta = 25°C)

CHARACTERISTIC	SYMBOL	TEST CONDITION	MIN.	TYP.	MAX.	UNIT
Forward Voltage	V_F	$I_F = 20\text{mA}$	—	2.15	2.8	V
Reverse Current	I_R	$V_R = 4\text{V}$	—	—	5	μA
Luminous Intensity	I_V	$I_F = 20\text{mA}$ (Note)	153	300	—	mcd
			TLGD245P (PQ)	153	—	
Peak Emission Wave Length	λ_p	$I_F = 20\text{mA}$	—	567	—	nm
Spectral Line Half Width	$\Delta\lambda$	$I_F = 20\text{mA}$	—	25	—	nm

(Note) Rank selection carried out under next standard range respectively, although it needs $\pm 15\%$ sdditionary for guaranteed limits.

P : 180-360mcd Q : 320-640mcd

Each rank products is classified by package unit, and (PQ) includes P and Q.

PRECAUTION

Please be careful of the followings.

- Soldering temperature : 260°C MAX. Soldering time : 3s MAX.
(Soldering portion of lead : up to 2mm from the body of the device)
- If the lead is formed, the lead should be formed up to 5mm from the body of the device without forming stress to the resin. Soldering should be performed after lead forming.

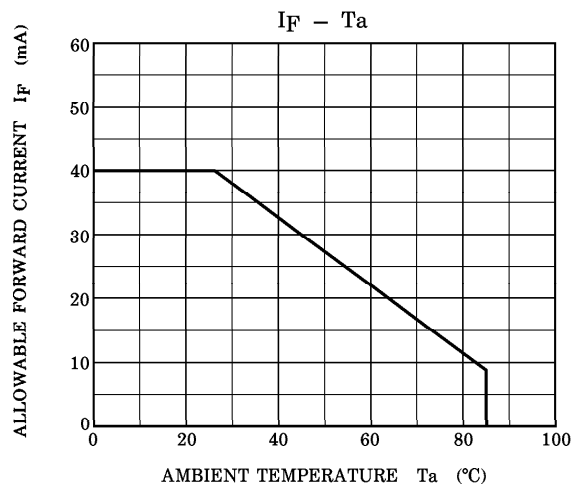
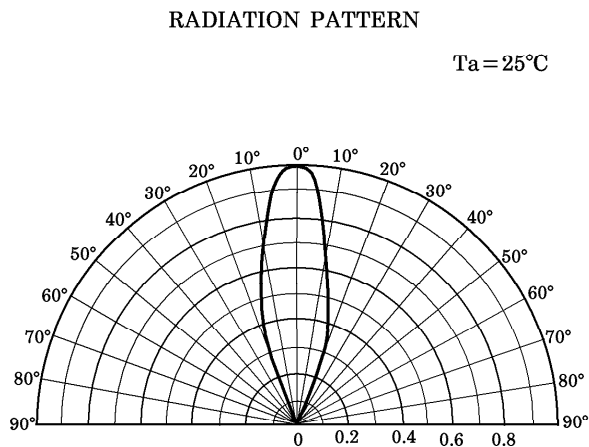
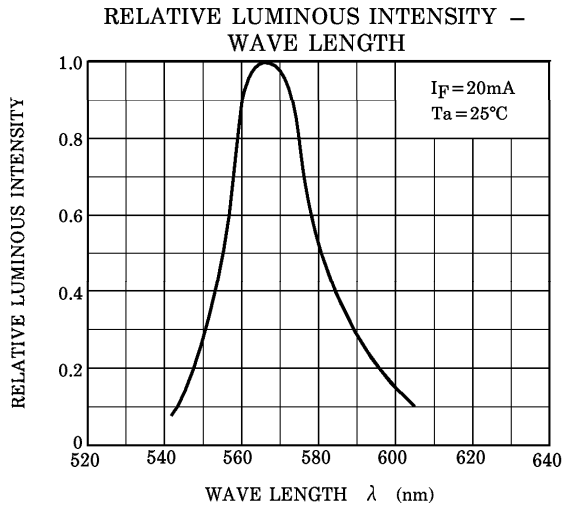
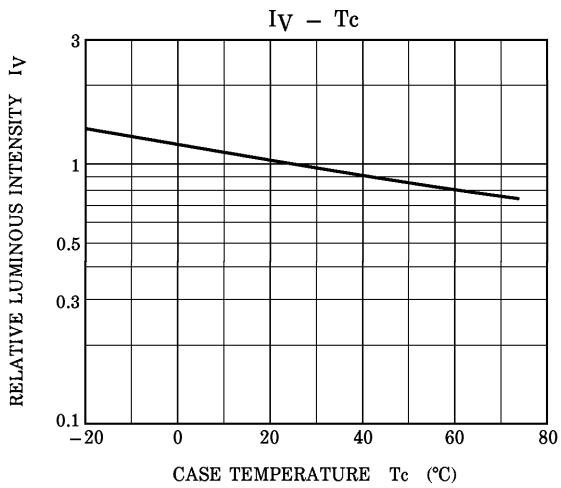
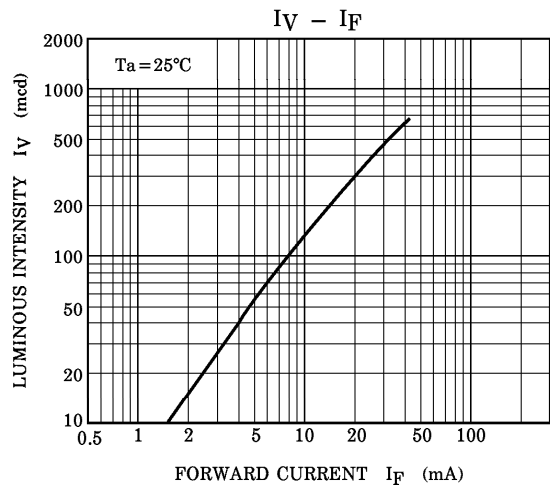
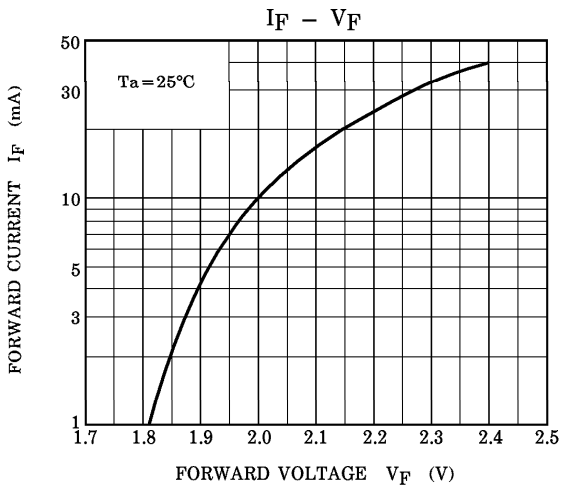

RESTRICTIONS ON PRODUCT USE

000707EAA

- TOSHIBA is continually working to improve the quality and reliability of its products. Nevertheless, semiconductor devices in general can malfunction or fail due to their inherent electrical sensitivity and vulnerability to physical stress. It is the responsibility of the buyer, when utilizing TOSHIBA products, to comply with the standards of safety in making a safe design for the entire system, and to avoid situations in which a malfunction or failure of such TOSHIBA products could cause loss of human life, bodily injury or damage to property. In developing your designs, please ensure that TOSHIBA products are used within specified operating ranges as set forth in the most recent TOSHIBA products specifications. Also, please keep in mind the precautions and conditions set forth in the "Handling Guide for Semiconductor Devices," or "TOSHIBA Semiconductor Reliability Handbook" etc..
- The TOSHIBA products listed in this document are intended for usage in general electronics applications (computer, personal equipment, office equipment, measuring equipment, industrial robotics, domestic appliances, etc.). These TOSHIBA products are neither intended nor warranted for usage in equipment that requires extraordinarily high quality and/or reliability or a malfunction or failure of which may cause loss of human life or bodily injury ("Unintended Usage"). Unintended Usage include atomic energy control instruments, airplane or spaceship instruments, transportation instruments, traffic signal instruments, combustion control instruments, medical instruments, all types of safety devices, etc.. Unintended Usage of TOSHIBA products listed in this document shall be made at the customer's own risk.
- The information contained herein is presented only as a guide for the applications of our products. No responsibility is assumed by TOSHIBA CORPORATION for any infringements of intellectual property or other rights of the third parties which may result from its use. No license is granted by implication or otherwise under any intellectual property or other rights of TOSHIBA CORPORATION or others.
- The information contained herein is subject to change without notice.