

TOSHIBA Photo-interrupter Infrared LED+Phototransistor

TLP1243(C8)

Copiers, Printers and Fax Machines
 Fanheaters and Air-conditioners
 Bank Atms
 Game Machines

The TLP1243 (C8) is a compact photointerrupter with a built-in connector, which uses a GaAs infrared LED and an Si phototransistor.

- Small package
 Compared to Toshiba TLP1241 (C5), the volume and the mounting area of the TLP1243 (C8) are reduced to 70% and 75% respectively.
- Three board thicknesses supported: 1.0 mm, 1.2 mm and 1.6 mm
- Gap: 5 mm
- Resolution: Slit width = 0.7 mm
- High-temperature operation: $T_{opr} = 95^{\circ}\text{C}$ (max)
- Current transfer ratio: $I_C/I_F = 2.5\%$ (min)
- Mini CT connector (1.5-mm pitch MT RECEPTACLE ASSEMBLY/HOUSING CRIMP TYPE) made by Tyco Electronics AMP, Ltd.
- Package and connector material: Polycarbonate (UL94V-2)
- Mounted with lead-free soldering alloys.

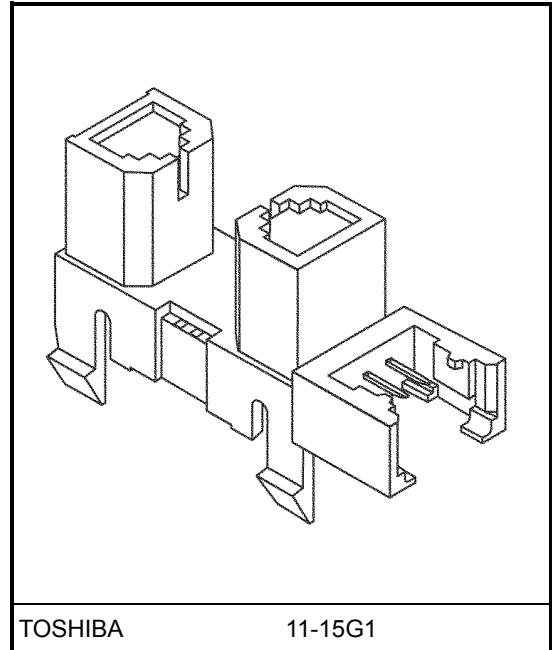

Weight: 0.8 g (typ.)

Marking

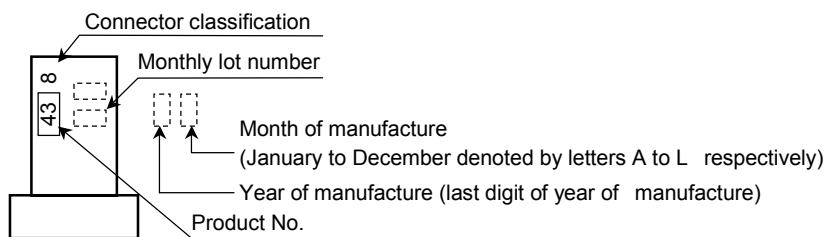

Maximum Ratings (Ta = 25°C)

Characteristics		Symbol	Rating	Unit
LED	Forward current	I_F	30	mA
	Forward current derating (Ta>25°C)	$\Delta I_F/^\circ\text{C}$	-0.28	mA/°C
	Reverse voltage	V_R	5	V
Detector	Collector-emitter voltage	V_{CEO}	35	V
	Emitter-collector voltage	V_{ECO}	5	V
	Collector power dissipation	P_C	75	mW
	Collector power dissipation derating (Ta>25°C)	$\Delta P_C/^\circ\text{C}$	-1	mW/°C
	Collector current	I_C	50	mA
Operating temperature range		T_{opr}	-30 to 95	°C
Storage temperature range		T_{stg}	-40 to 100	°C

Optical and Electrical Characteristics (Ta = 25°C)

Characteristics		Symbol	Test conditions	Min	Typ.	Max	Unit
LED	Forward voltage	V_F	$I_F = 10 \text{ mA}$	1.00	1.18	1.40	V
	Reverse current	I_R	$V_R = 5 \text{ V}$	—	—	10	μA
	Peak emission wavelength	λ_P	$I_F = 10 \text{ mA}$	—	940	—	nm
Detector	Dark current	$I_D (I_{CEO})$	$V_{CE} = 24 \text{ V}, I_F = 0$	—	0.001	0.1	μA
	Peak sensitivity wavelength	λ_P	—	—	870	—	nm
Coupled	Current transfer ratio	I_C/I_F	$V_{CE} = 2 \text{ V}, I_F = 10 \text{ mA}$	2.5	—	100	%
	Collector-emitter saturation voltage	$V_{CE}(\text{sat})$	$I_F = 20 \text{ mA}, I_C = 0.25 \text{ mA}$	—	0.1	0.35	V
	Rise time	t_r	$V_{CE} = 5 \text{ V}, I_C = 1 \text{ mA}, R_L = 1 \text{ k}\Omega$	—	15	50	μs
	Fall time	t_f		—	15	50	

Pin Strength (Ta = 25°C)

Characteristics	Test conditions		Limit
	Direction	A	
Pulling	Weight	19.6N	No defect in electrical characteristics
	Time	5 s/once	
	Direction	B	
Bending	Weight	9.8N	
	Time	5 s/three times	
	Direction	A	

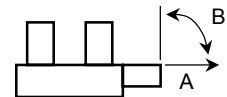

Recommended Connector

**Mini CT connector (1.5-mm pitch, MT RECEPTACLE ASSEMBLY/HOUSING CRIMP TYPE)
made by Tyco Electronics AMP, Ltd.**

	Type	Model Number	Terminal Material	AWG Size	External Diameter of Insulation Coating
Housing-Terminal En Block Type	MT RECEPTACLE ASSEMBLY	353293-3	Phosphor bronze	AWG26 to 28	0.85 mm to 0.95 mm
	HOUSING CRIMP TYPE	353908-3			

Note: For more of connector characteristics, please contact the relevant connector manufacturer.

Precautions

- Keep the device away from external light. Although the photo-IC is of low optical sensitivity, the device may malfunction if external light with a wavelength of 700 nm or more is allowed to impinge on it.
- Care must be taken in relation to the environment in which the device is to be installed. Oil or chemicals may cause the package to melt or crack.
- When attaching the device to the metal board, always hold the body of the device. Do not hold it by the connector. Ensure that the board is flat, and not warped or twisted. Attach the device to a metal board at room temperature.
- Toshiba recommends attaching the device to the smoother side of the board.
- Toshiba recommends testing the attachment strength beforehand by actually attaching a device to the board.
- Do not apply solder to the pins of the device's connector. Make sure that the connector is plugged into the Mini CT connector or equivalent connector.
- When inserting or removing the Mini CT connector or equivalent connector, always grasp it and its cable firmly and either plug it straight into or pull it straight out of the device's connector. If the Mini CT connector or equivalent connector is inserted or removed at an angle, both the device's connector and the Mini CT connector or equivalent connector may get damaged, resulting in an unreliable connection.
- Conversion efficiency falls over time due to the current which flows in the infrared LED. When designing a circuit, take into account this change in conversion efficiency over time. The ratio of fluctuation in conversion efficiency to fluctuation in infrared LED optical output is 1:1.

$$\frac{I_C/I_F(t)}{I_C/I_F(0)} = \frac{P_o(t)}{P_o(0)}$$

Package Dimensions: TOSHIBA 11-15G1

Unit: mm

() : Reference value
Tolerances are listed below unless otherwise specified.

Dimensions	Tolerance
6 mm or less	±0.1
Greater than 6 mm	±0.2

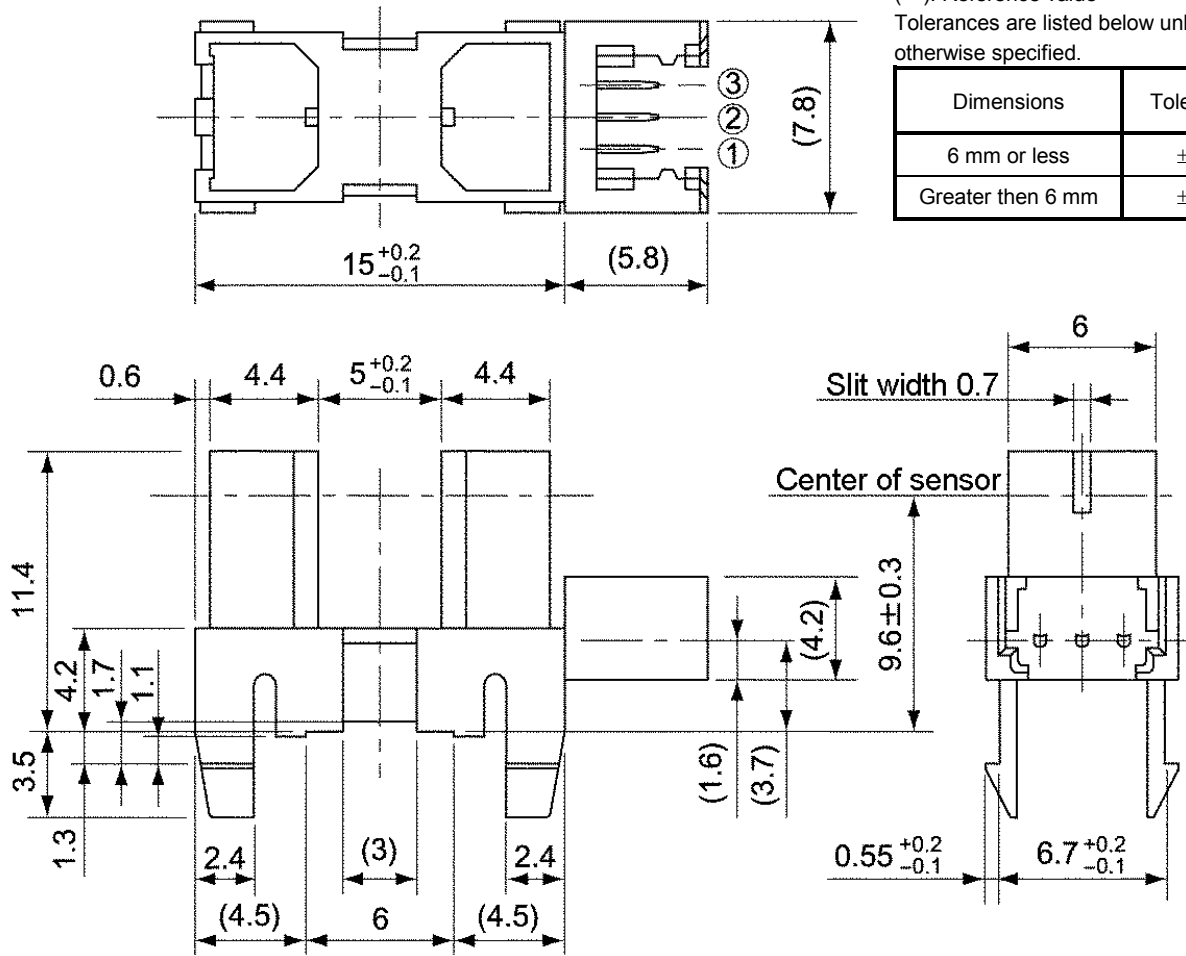

Pin Connection

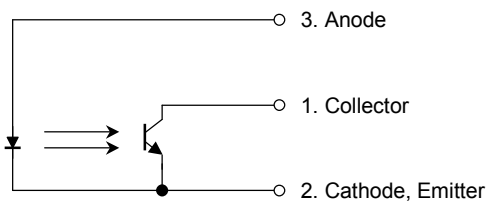

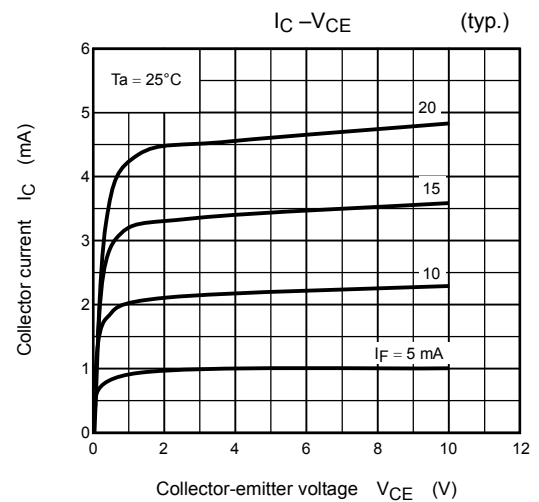
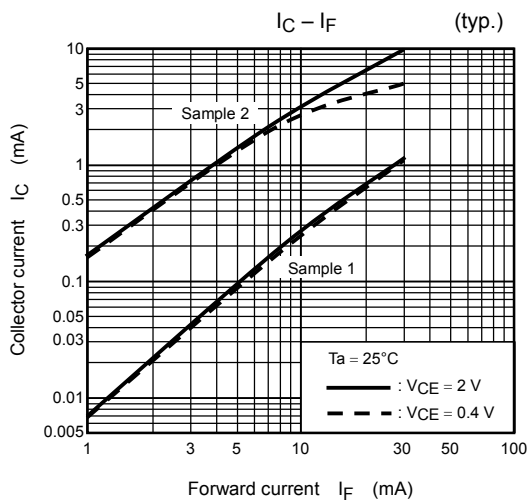
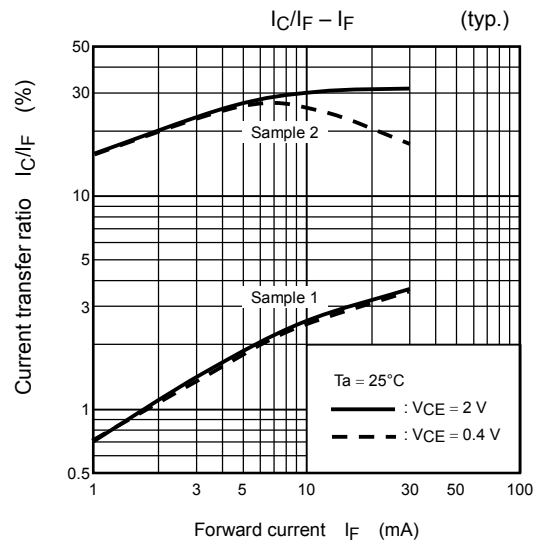
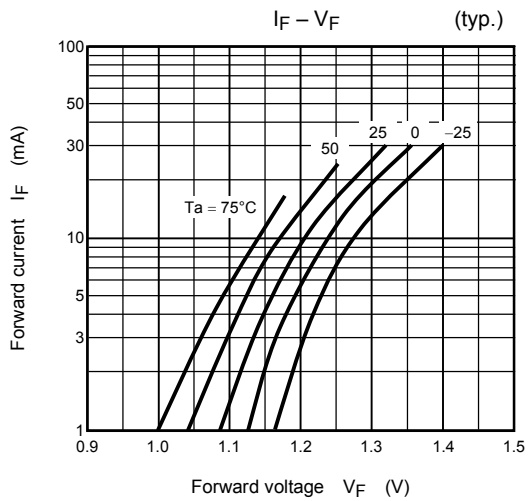
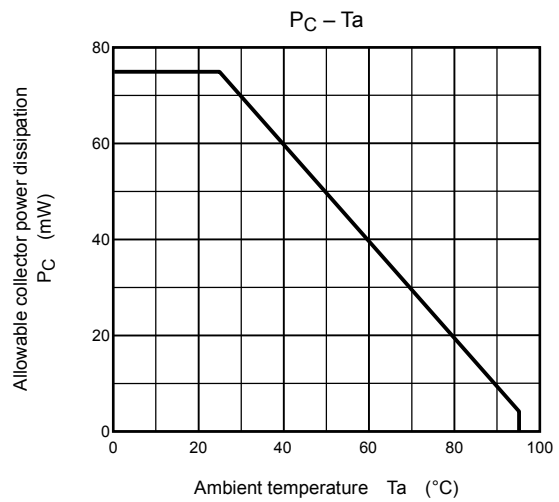
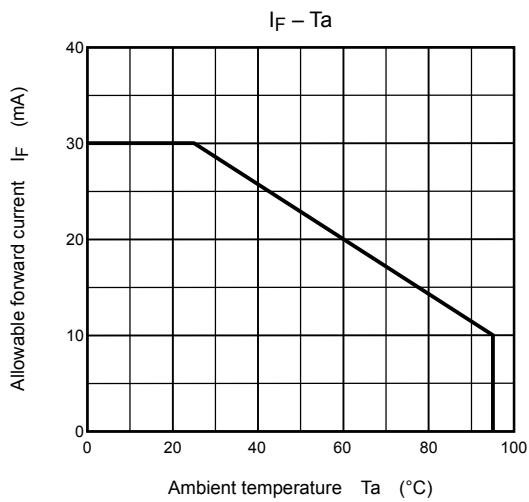

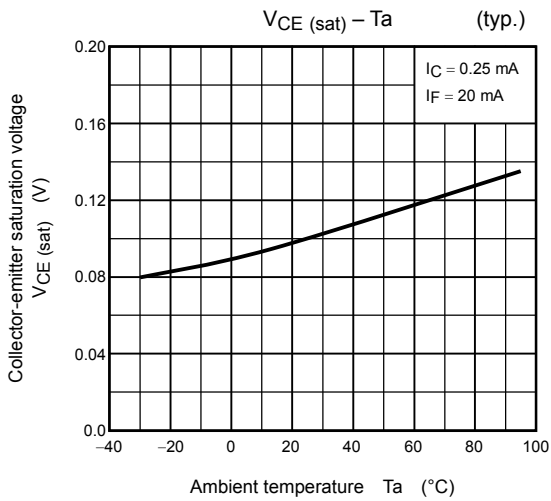
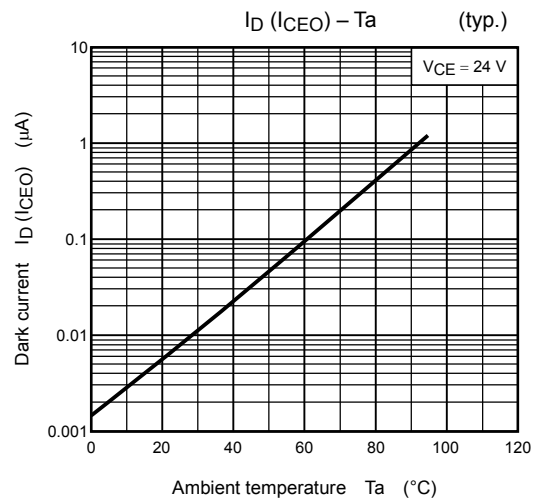
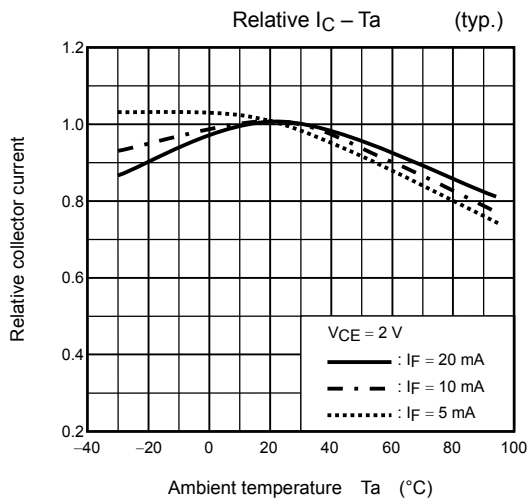

Switching Time Test Circuit

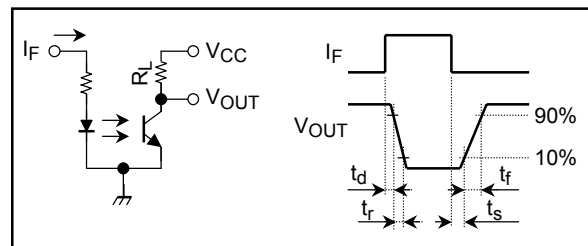

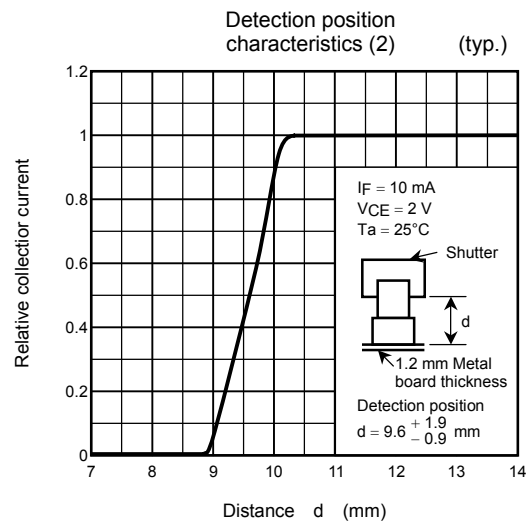
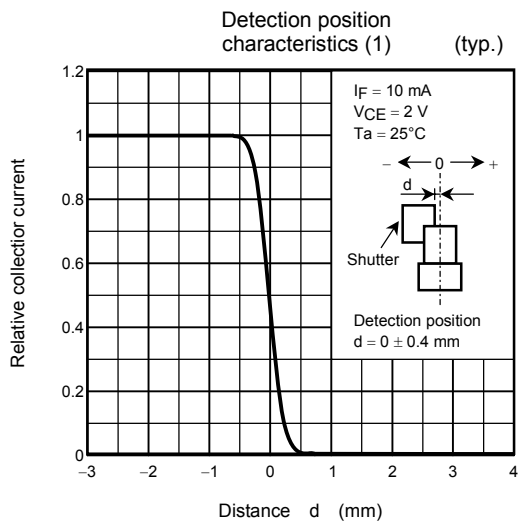
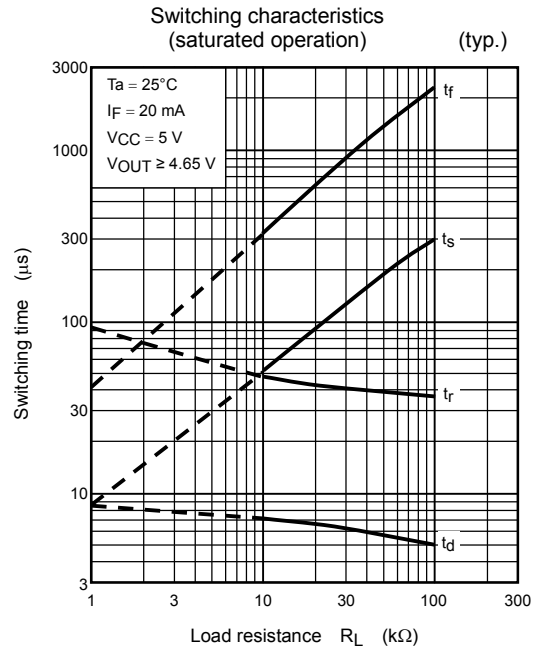
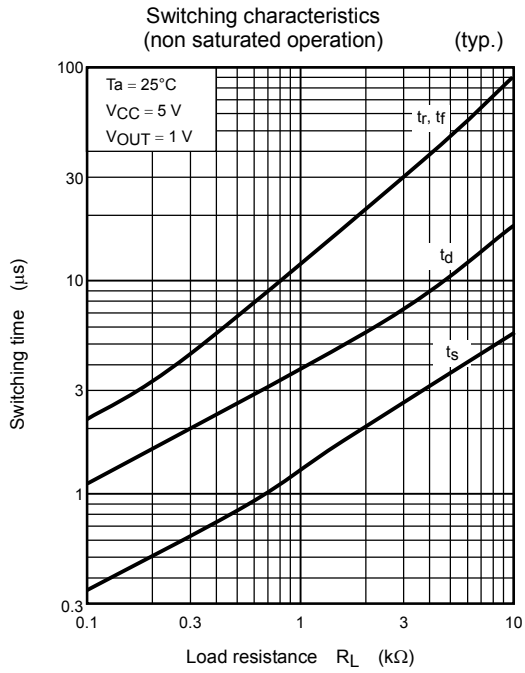

Relative Positioning of Shutter and Device

For normal operation, position the shutter and the device as shown in the figure below. By considering the device's detection direction characteristic and switching time, determine the shutter slit width and pitch.

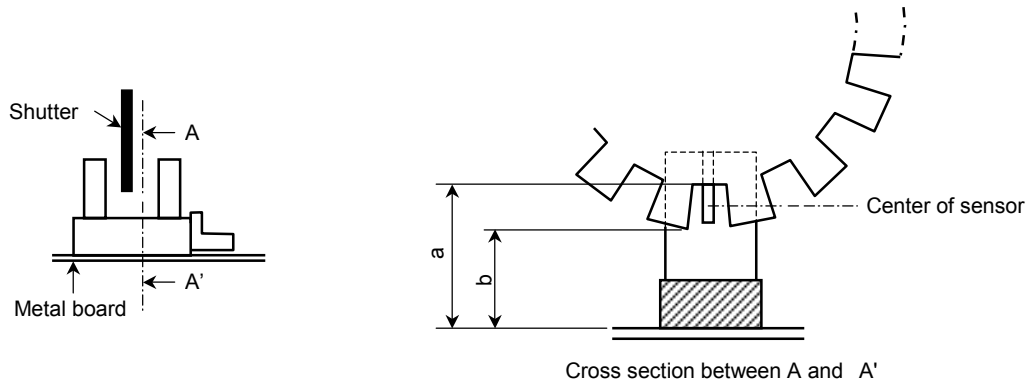

Unit: mm

Thickness of Metal Board	a Dimension	b Dimension
1.0	11.7 min	8.9 max
1.2	11.5 min	8.7 max
1.6	11.1 min	8.3 max

Recommended Size of Connection Holes (Unit: mm)

1.0 mm thick metal board

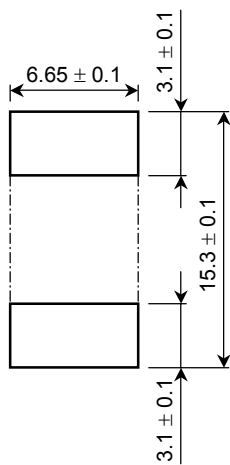

1.2 mm thick metal board

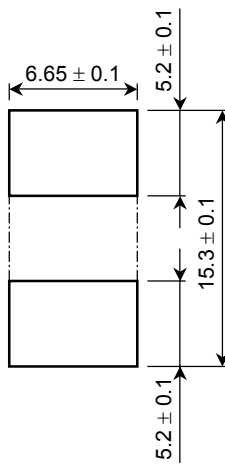

1.6 mm thick metal board

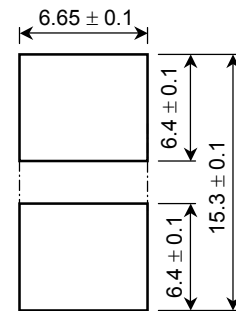

RESTRICTIONS ON PRODUCT USE

020704EAC

- TOSHIBA is continually working to improve the quality and reliability of its products. Nevertheless, semiconductor devices in general can malfunction or fail due to their inherent electrical sensitivity and vulnerability to physical stress. It is the responsibility of the buyer, when utilizing TOSHIBA products, to comply with the standards of safety in making a safe design for the entire system, and to avoid situations in which a malfunction or failure of such TOSHIBA products could cause loss of human life, bodily injury or damage to property.
In developing your designs, please ensure that TOSHIBA products are used within specified operating ranges as set forth in the most recent TOSHIBA products specifications. Also, please keep in mind the precautions and conditions set forth in the "Handling Guide for Semiconductor Devices," or "TOSHIBA Semiconductor Reliability Handbook" etc..
- The TOSHIBA products listed in this document are intended for usage in general electronics applications (computer, personal equipment, office equipment, measuring equipment, industrial robotics, domestic appliances, etc.). These TOSHIBA products are neither intended nor warranted for usage in equipment that requires extraordinarily high quality and/or reliability or a malfunction or failure of which may cause loss of human life or bodily injury ("Unintended Usage"). Unintended Usage include atomic energy control instruments, airplane or spaceship instruments, transportation instruments, traffic signal instruments, combustion control instruments, medical instruments, all types of safety devices, etc.. Unintended Usage of TOSHIBA products listed in this document shall be made at the customer's own risk.
- Gallium Arsenide (GaAs) is a substance used in the products described in this document. GaAs dust or vapor is harmful to the human body. Do not break , cut, crush or dissolve chemically.
- The information contained herein is presented only as a guide for the applications of our products. No responsibility is assumed by TOSHIBA CORPORATION for any infringements of intellectual property or other rights of the third parties which may result from its use. No license is granted by implication or otherwise under any intellectual property or other rights of TOSHIBA CORPORATION or others.
- The information contained herein is subject to change without notice.