

Silicon Switching Diodes

BAS 19
... BAS 21

- High-speed, high-voltage switch

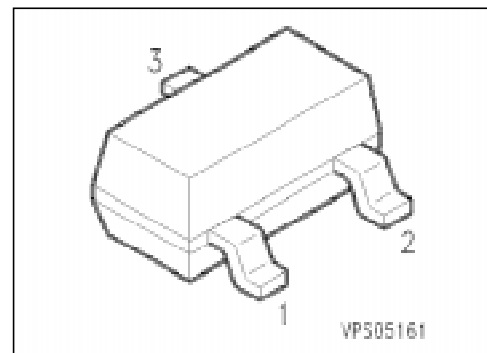

Type	Marking	Ordering Code (tape and reel)	Pin Configuration	Package ¹⁾
BAS 19 BAS 20 BAS 21	JPs JRs JSs	Q62702-A95 Q62702-A113 Q62702-A79		SOT-23

Maximum Ratings

Parameter	Symbol	Values			Unit
		BAS 19	BAS 20	BAS 21	
Reverse voltage	V_R	100	150	200	V
Peak reverse voltage	V_{RM}	120	200	250	
Forward current	I_F	250			mA
Peak forward current	I_{FM}	625			
Total power dissipation, $T_s = 70\text{ °C}$	P_{tot}	350			mW
Junction temperature	T_j	150			°C
Storage temperature range	T_{stg}	- 65 ... + 150			

Thermal Resistance

Junction - ambient ²⁾	$R_{th\ JA}$	≤ 300	K/W
Junction - soldering point	$R_{th\ JS}$	≤ 230	

¹⁾ For detailed information see chapter Package Outlines.

²⁾ Package mounted on epoxy pcb 40 mm × 40 mm × 1.5 mm/6 cm² Cu.

Electrical Characteristics

at $T_A = 25\text{ °C}$, unless otherwise specified.

Parameter	Symbol	Values			Unit
		min.	typ.	max.	

DC characteristics

Breakdown voltage ¹⁾ $I_{(BR)} = 100\text{ }\mu\text{A}$	BAS 19 BAS 20 BAS 21	$V_{(BR)}$	120 200 250	— — —	— — —	V
Forward voltage $I_F = 100\text{ mA}$ $I_F = 200\text{ mA}$		V_F	— —	— —	1 1.25	
Reverse current $V_R = V_{R\text{ max}}$ $V_R = V_{R\text{ max}}$; $T_j = 150\text{ °C}$		I_R	— —	— —	100 100	nA μA

AC characteristics

Diode capacitance $V_R = 0\text{ V}$, $f = 1\text{ MHz}$		C_D	—	—	5	pF
Reverse recovery time $I_F = 30\text{ mA}$, $I_R = 30\text{ mA}$, $R_L = 100\text{ }\Omega$ measured at $I_R = 3\text{ mA}$		t_{rr}	—	—	50	ns

Test circuit for reverse recovery time

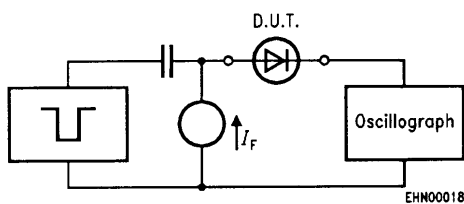

Pulse generator: $t_p = 100\text{ ns}$, $D = 0.05$
 $t_r = 0.6\text{ ns}$, $R_j = 50\text{ }\Omega$

Oscilloscope: $R = 50\text{ }\Omega$
 $t_r = 0.35\text{ ns}$
 $C \leq 1\text{ pF}$

¹⁾ Pulse test: $t_p \leq 300\text{ }\mu\text{s}$, $D = 2\text{ %}$.

Forward current $I_F = f(T_A^*; T_S)$

* Package mounted on epoxy

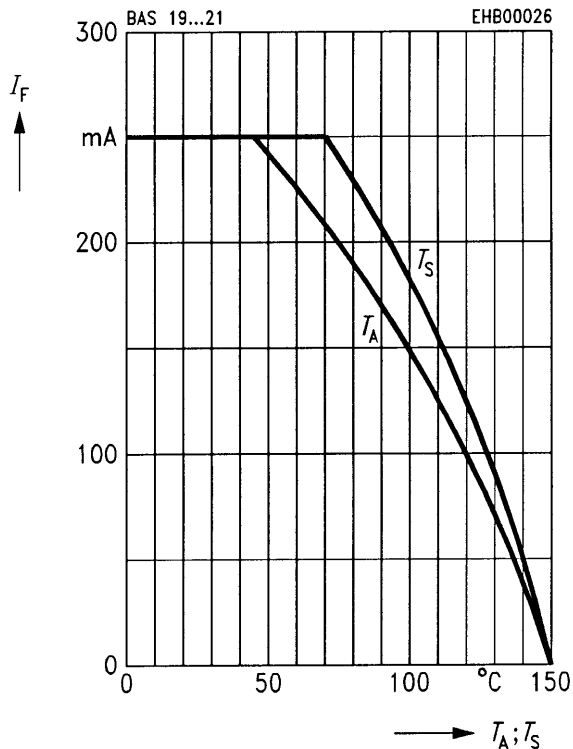

Reverse current $I_R = f(T_A)$

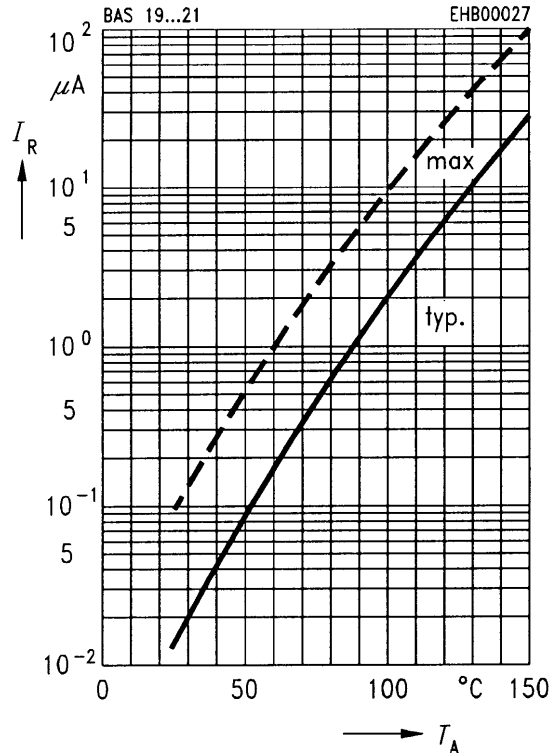

Forward current $I_F = f(V_F)$

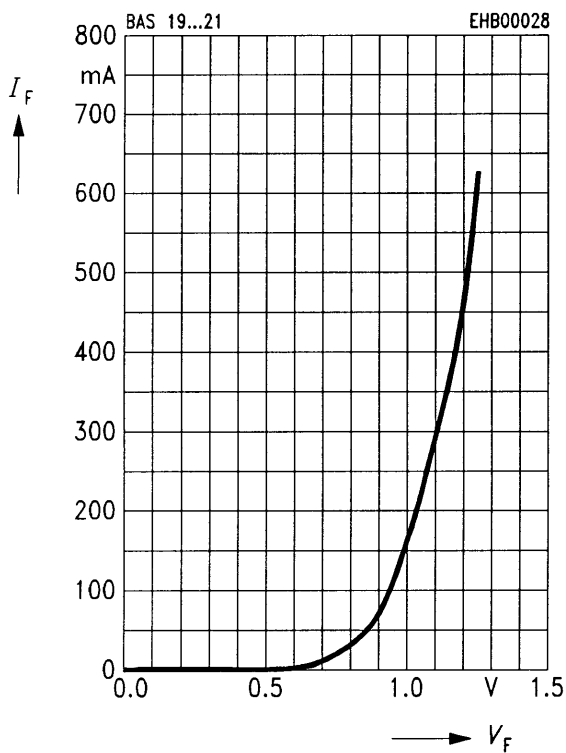

Forward voltage $V_F = f(T_A)$

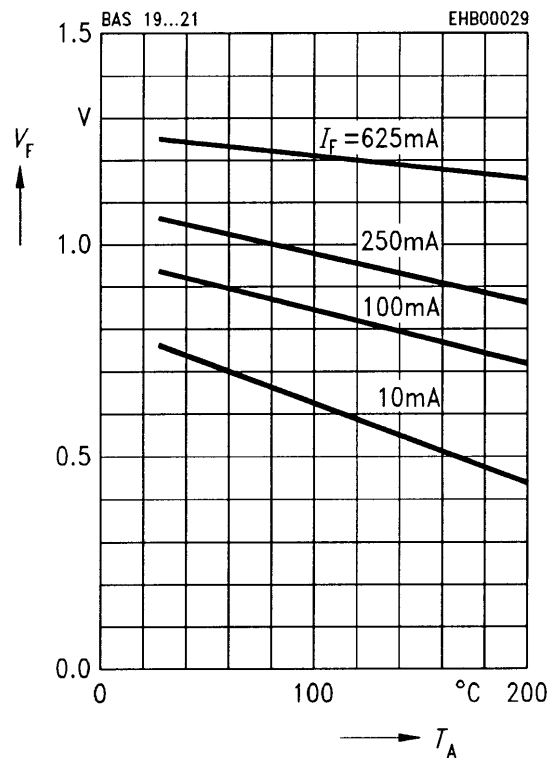

Reverse voltage $V_R = f(T_A)$

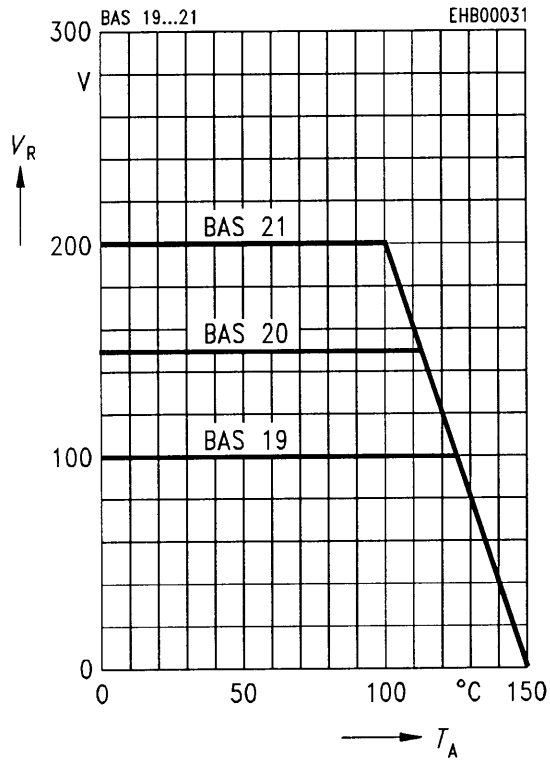

Peak forward current $I_{FM} = f(t)$

