

## Silicon Schottky Diodes

### Preliminary data

- For low-loss, fast-recovery, meter protection, bias isolation and clamping applications
- Integrated diffused guard ring
- Low forward voltage

### Pin Configuration

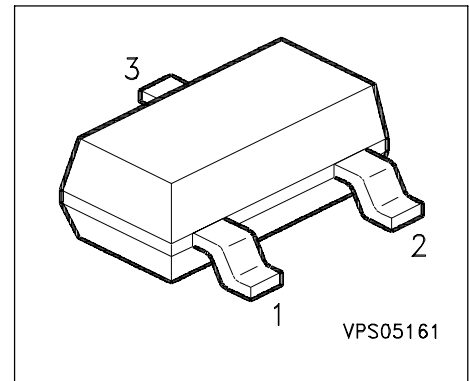

BAT 64-04

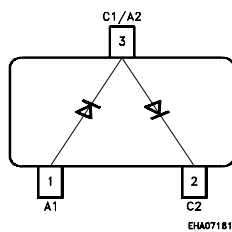

BAT64-05

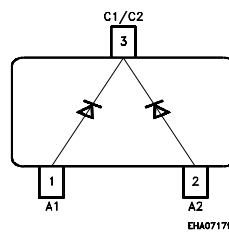

BAT64-06

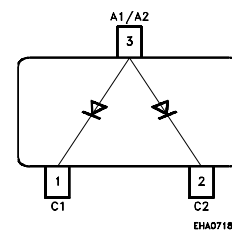

**ESD: ElectroStatic Discharge sensitive device, observe handling precautions!**

Type	Marking	Ordering Code	Pin Configuration			Package
BAT 64	63s	Q62702-A879	1 = A		3 = C	SOT-23
BAT 64-04	64s	Q62702-A961	1 = A	2 = C	3 = C/A	SOT-23
BAT 64-05	65s	Q62702-A962	1 = A	2 = A	3 = C/C	SOT-23
BAT 64-06	66s	Q62702-A963	1 = C	2 = C	3 = A/A	SOT-23

### Maximum Ratings

Parameter	Symbol	Values	Unit
Diode reverse voltage	$V_R$	40	V
Forward current	$I_F$	250	mA
Average forward current (50/60Hz, sinus)	$I_{FAV}$	120	
Surge forward current ( $t \leq 10ms$ )	$I_{FSM}$	800	
Total Power dissipation $T_S = 61 \text{ }^\circ\text{C}$	$P_{tot}$	250	mW
Junction temperature	$T_j$	150	$^\circ\text{C}$
Storage temperature	$T_{stg}$	- 55 ... + 150	

### Thermal Resistance

Junction ambient <sup>1)</sup>	$R_{thJA}$	$\leq 495$	K/W
Junction - soldering point	$R_{thJS}$	$\leq 355$	

1) Package mounted on epoxy pcb 40mm x 40mm x 1.5mm / 0.5cm<sup>2</sup> Cu

### Electrical Characteristics at $T_A=25^\circ\text{C}$ , unless otherwise specified

Parameter	Symbol	Values			Unit
		min.	typ.	max.	

#### DC characteristics

Reverse current $V_R = 25\text{ V}, T_A = 25^\circ\text{C}$ $V_R = 25\text{ V}, T_A = 85^\circ\text{C}$	$I_R$	-	-	2 200	$\mu\text{A}$
Forward voltage $I_F = 1\text{ mA}$ $I_F = 10\text{ mA}$ $I_F = 30\text{ mA}$ $I_F = 100\text{ mA}$	$V_F$	-	320 385 440 570	350 430 520 750	mV V

#### AC Characteristics

Diode capacitance $V_R = 1\text{ V}, f = 1\text{ MHz}$	$C_T$	-	4	6	pF
---	-------	---	---	---	----

#### Forward Current $I_F = f(V_F)$

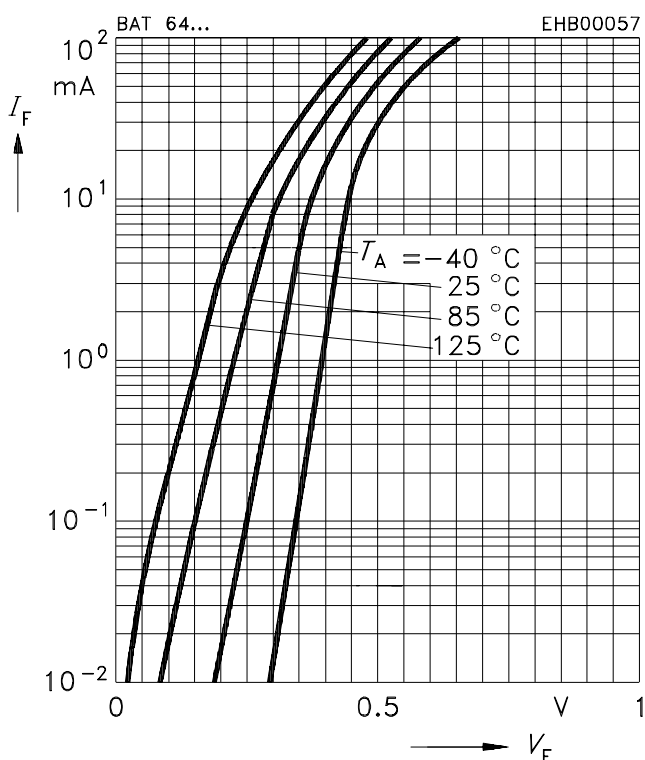

#### Reverse current $I_R = f(V_R)$

$T_A = \text{Parameter}$

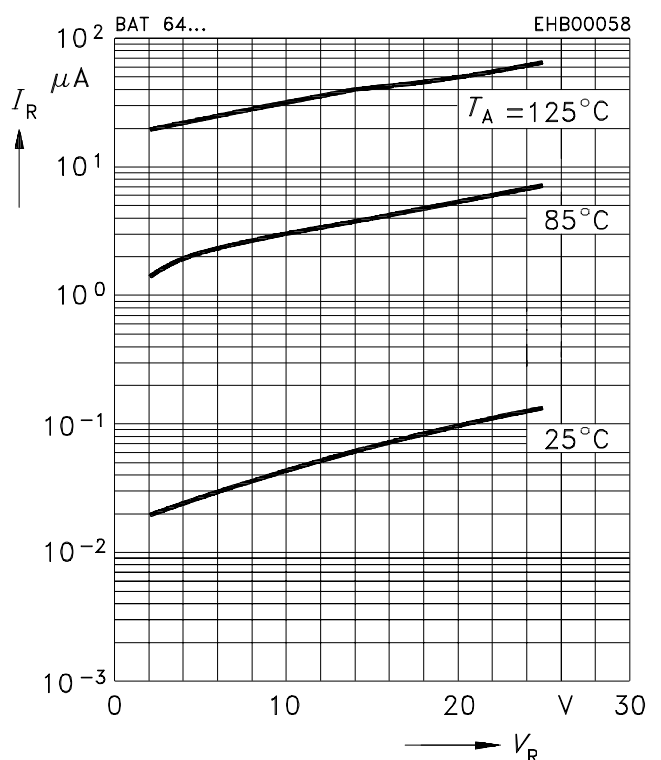

### Diode capacitance $C_T = f(V_R)$

$f = 1\text{MHz}$

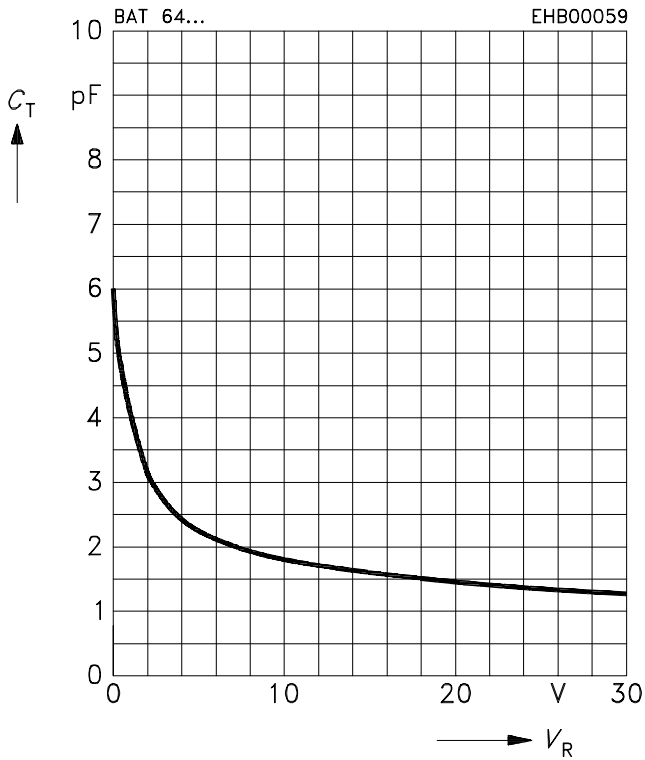

### Forward current $I_F = f(T_A^*; T_S)$

\* Package mounted on epoxy

BAT 64

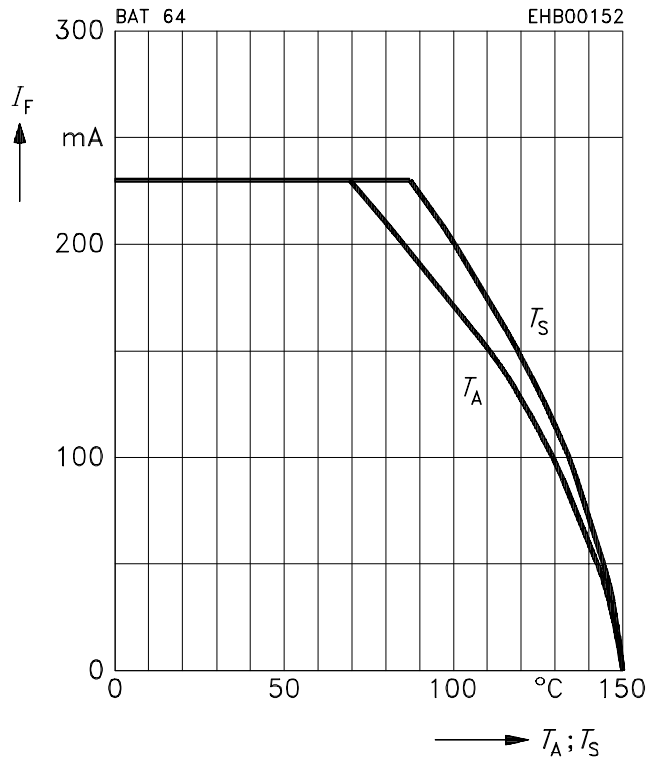

### Forward current $I_F = f(T_A^*; T_S)$

\* Package mounted on epoxy

BAT 64-04... ( $I_F$  per diode)

