

PNP Silicon AF Transistors

BC 636
... **BC 640**

- High current gain
- High collector current
- Low collector-emitter saturation voltage
- Complementary types: BC 635, BC 637,
BC 639 (NPN)

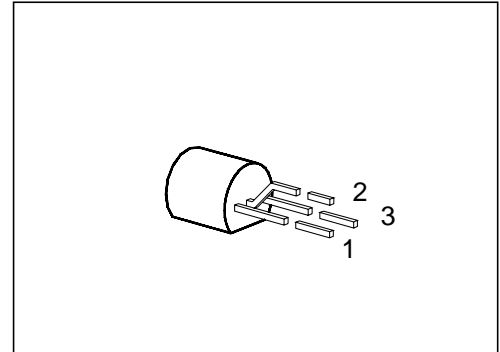

Type	Marking	Ordering Code	Pin Configuration			Package ¹⁾
			1	2	3	
BC 636	—	Q68000-A3365	E	C	B	TO-92
BC 638		Q68000-A3366				
BC 640		Q68000-A3367				

If desired, selected transistors, type BC 6 ★ ★ -10 ($h_{FE} = 63 \dots 160$), or BC 6 ★ ★ -16 ($h_{FE} = 100 \dots 250$) are available. Ordering codes upon request.

¹⁾ For detailed information see chapter Package Outlines.

Maximum Ratings

Parameter	Symbol	Values			Unit
		BC 636	BC 638	BC 640	
Collector-emitter voltage	V_{CE0}	45	60	80	V
Collector-base voltage	V_{CB0}	45	60	100	
Emitter-base voltage	V_{EB0}	5			
Collector current	I_C	1			A
Peak collector current	I_{CM}	1.5			
Base current	I_B	100			mA
Peak base current	I_{BM}	200			
Total power dissipation, $T_C = 90\text{ °C}^1$	P_{tot}	0.8 (1)			W
Junction temperature	T_j	150			°C
Storage temperature range	T_{stg}	- 65 ... + 150			

Thermal Resistance

Junction - ambient ¹⁾	$R_{th JA}$	≤ 156	K/W
Junction - case ²⁾	$R_{th JC}$	≤ 55	

1) If the transistors with max. 4 mm lead length are fixed on PCBs with a min. 10 mm x 10 mm large copper area for the collector terminal, $R_{th JA} = 125\text{ K/W}$ and thus $P_{tot max} = 1\text{ W}$ at $T_A = 25\text{ °C}$.

2) Mounted on Al heat sink 15 mm × 25 mm × 0.5 mm.

Electrical Characteristics

at $T_A = 25\text{ °C}$, unless otherwise specified.

Parameter	Symbol	Values			Unit
		min.	typ.	max.	

DC characteristics

Collector-emitter breakdown voltage $I_C = 10\text{ mA}$	$V_{(BR)CE0}$				V
BC 636		45	–	–	
BC 638		60	–	–	
BC 640		80	–	–	
Collector-base breakdown voltage $I_C = 100\text{ }\mu\text{A}$	$V_{(BR)CB0}$				
BC 636		45	–	–	
BC 638		60	–	–	
BC 640		100	–	–	
Emitter-base breakdown voltage $I_E = 10\text{ }\mu\text{A}$	$V_{(BR)EB0}$	5	–	–	
Collector cutoff current $V_{CB} = 30\text{ V}$ $V_{CB} = 30\text{ V}, T_A = 150\text{ °C}$	I_{CB0}	–	–	100	nA
		–	–	20	μA
Emitter cutoff current $V_{EB} = 4\text{ V}$	I_{EB0}	–	–	100	nA
DC current gain $I_C = 5\text{ mA}; V_{CE} = 2\text{ V}$ $I_C = 150\text{ mA}; V_{CE} = 2\text{ V}^{1)}$ $I_C = 500\text{ mA}; V_{CE} = 2\text{ V}^{1)}$	h_{FE}	25	–	–	–
		40	–	250	
		25	–	–	
Collector-emitter saturation voltage ¹⁾ $I_C = 500\text{ mA}; I_B = 50\text{ mA}$	V_{CEsat}	–	–	500	mV
Base-emitter voltage ¹⁾ $I_C = 500\text{ mA}; V_{CE} = 2\text{ V}$	V_{BE}	–	–	1	V

AC characteristics

Transition frequency $I_C = 50\text{ mA}, V_{CE} = 10\text{ V}, f = 20\text{ MHz}$	f_T	–	100	–	MHz
---	-------	---	-----	---	-----

¹⁾ Pulse test: $t \leq 300\text{ }\mu\text{s}, D \leq 2\%$.

Total power dissipation $P_{tot} = f(T_A; T_C)$

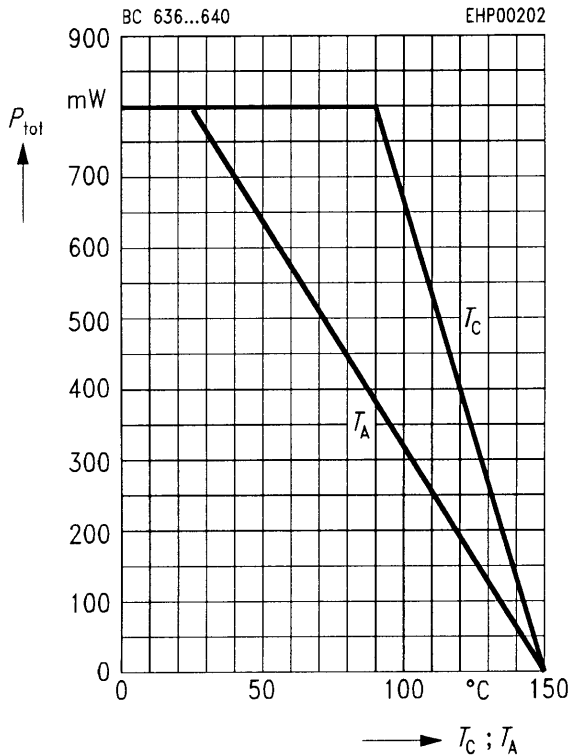

**Collector cutoff current $I_{CB0} = f(T_A)$
 $V_{CB} = 30\text{ V}$**

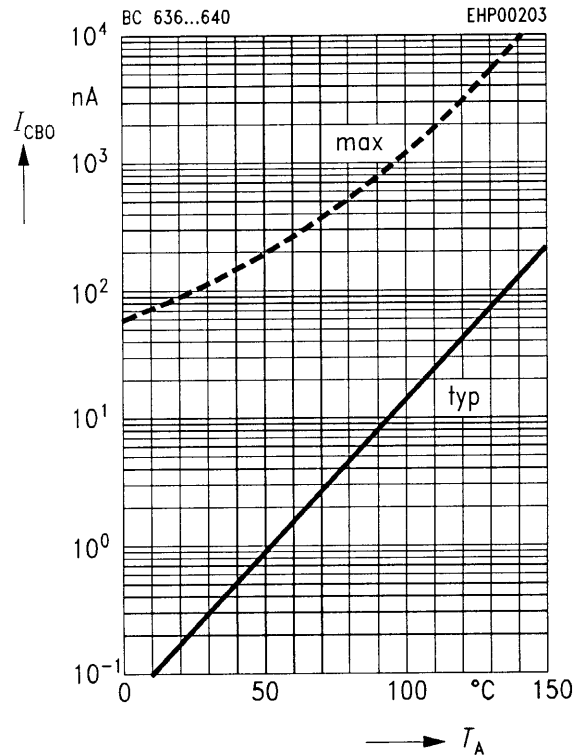

Permissible pulse load $R_{thJA} = f(t_p)$

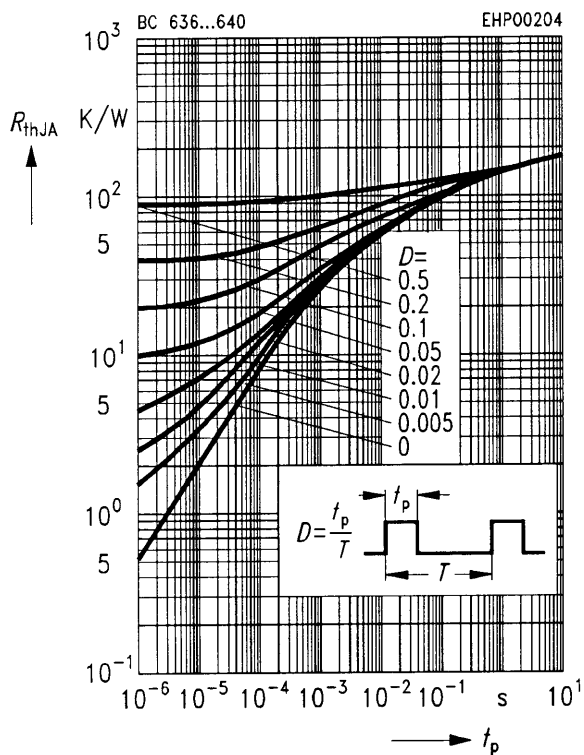

**Collector current $I_C = f(V_{BE})$
 $V_{CE} = 2\text{ V}$**

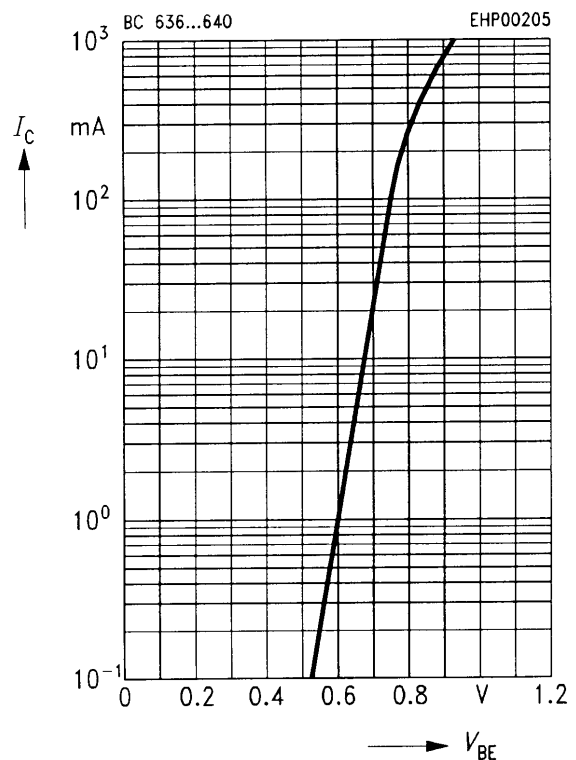

DC current gain $h_{FE} = f(I_C)$

$V_{CE} = 2 \text{ V}$

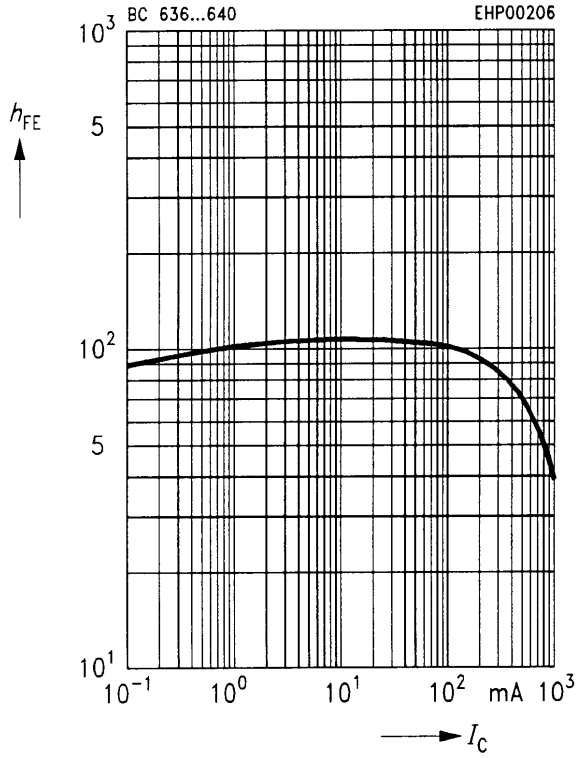

Collector-emitter saturation voltage $V_{CEsat} = f(I_C)$

$h_{FE} = 10$

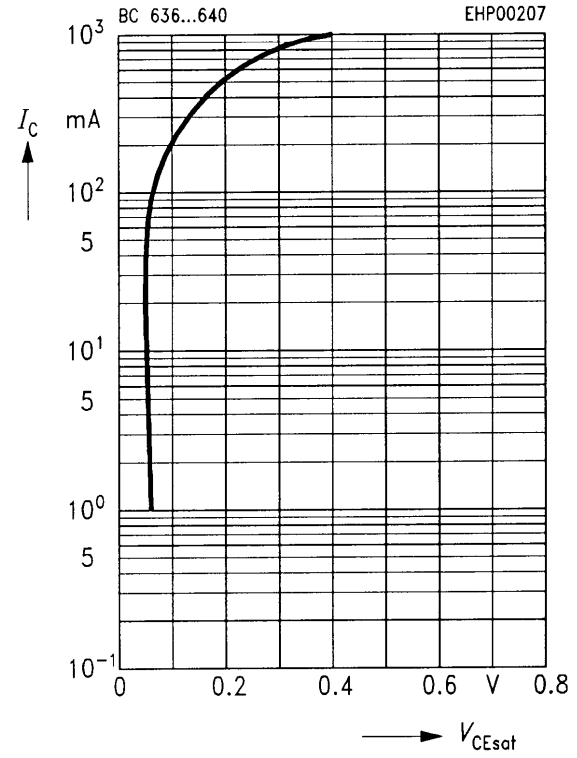

Transition frequency $f_T = f(I_C)$

