

NPN Silicon AF and Switching Transistor

BCX 41
BSS 64

- High breakdown voltage
- Low collector-emitter saturation voltage
- Complementary types: BCX 42, BSS 63 (PNP)

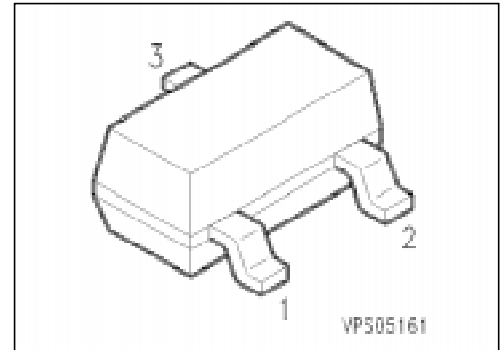

Type	Marking	Ordering Code (tape and reel)	Pin Configuration			Package ¹⁾
			1	2	3	
BCX 41 BSS 64	EKs AMs	Q62702-C1659 Q62702-S535	B	E	C	SOT-23

Maximum Ratings

Parameter	Symbol	Values		Unit
		BSS 64	BCX 41	
Collector-emitter voltage	V_{CE0}	80	125	V
Collector-base voltage	V_{CB0}	120	125	
Emitter-base voltage	V_{EB0}	5	5	
Collector current	I_C	800		mA
Peak collector current	I_{CM}	1		A
Base current	I_B	100		mA
Peak base current	I_{BM}	200		
Total power dissipation, $T_s = 79\text{ °C}$	P_{tot}	330		mW
Junction temperature	T_j	150		°C
Storage temperature range	T_{stg}	- 65 ... + 150		

Thermal Resistance

Junction - ambient ²⁾	$R_{th\ JA}$	≤ 285	K/W
Junction - soldering point	$R_{th\ JS}$	≤ 215	

¹⁾ For detailed information see chapter Package Outlines.

²⁾ Package mounted on epoxy pcb 40 mm × 40 mm × 1.5 mm/6 cm² Cu.

Electrical Characteristics at $T_A = 25\text{ °C}$, unless otherwise specified.

Parameter	Symbol	Values			Unit	
		min.	typ.	max.		
DC characteristics						
Collector-emitter breakdown voltage $I_C = 10\text{ mA}$	BSS 64 BCX 41	$V_{(BR)CE0}$	80 125	— —	— —	V
Collector-base breakdown voltage ¹⁾ $I_C = 100\text{ }\mu\text{A}$	BSS 64 BCX 41	$V_{(BR)CB0}$	120 125	— —	— —	
Emitter-base breakdown voltage $I_E = 10\text{ }\mu\text{A}$		$V_{(BR)EB0}$	5	—	—	
Collector cutoff current $V_{CB} = 80\text{ V}$ $V_{CB} = 100\text{ V}$ $V_{CB} = 80\text{ V}, T_A = 150\text{ °C}$ $V_{CB} = 100\text{ V}, T_A = 150\text{ °C}$	BSS 64 BCX 41 BSS 64 BCX 41	I_{CB0}	— — — —	— — — —	100 100 20 20	nA nA μA μA
Collector cutoff current $V_{CE} = 100\text{ V}$ $T_A = 85\text{ °C}$ $T_A = 125\text{ °C}$	BCX 41 BCX 41	I_{CE0}	— —	— —	10 75	μA
Emitter cutoff current $V_{EB} = 4\text{ V}$		I_{EB0}	—	—	100	nA
DC current gain ¹⁾ $I_C = 100\text{ }\mu\text{A}, V_{CE} = 1\text{ V}$ $I_C = 1\text{ mA}, V_{CE} = 1\text{ V}$ $I_C = 4\text{ mA}, V_{CE} = 1\text{ V}$ $I_C = 10\text{ mA}, V_{CE} = 1\text{ V}$ $I_C = 20\text{ mA}, V_{CE} = 1\text{ V}$ $I_C = 100\text{ mA}, V_{CE} = 1\text{ V}$ $I_C = 200\text{ mA}, V_{CE} = 1\text{ V}$	BCX 41 BSS 64 BSS 64 BSS 64 BSS 64 BCX 41 BCX 41	h_{FE}	25 — 20 — — 63 40	— 60 80 80 55 — —	— — — — — — —	—
Collector-emitter saturation voltage ¹⁾ $I_C = 300\text{ mA}, I_B = 30\text{ mA}$ $I_C = 4\text{ mA}, I_B = 0.4\text{ mA}$ $I_C = 50\text{ mA}, I_B = 15\text{ mA}$	BCX 41 BSS 64 BSS 64	V_{CEsat}	— — —	— — —	0.9 0.7 3.0	V
Base-emitter saturation voltage ¹⁾ $I_C = 300\text{ mA}, I_B = 30\text{ mA}$	BCX 41	V_{BEsat}	—	—	1.4	
AC characteristics						
Transition frequency $I_C = 20\text{ mA}, V_{CE} = 5\text{ V}, f = 20\text{ MHz}$		f_T	—	100	—	MHz
Output capacitance $V_{CB} = 10\text{ V}, f = 1\text{ MHz}$		C_{obo}	—	12	—	pF

1) Pulse test: $t \leq 300\text{ }\mu\text{s}, D = 2\%$

Total power dissipation $P_{tot} = f(T_A^*; T_S)$

* Package mounted on epoxy

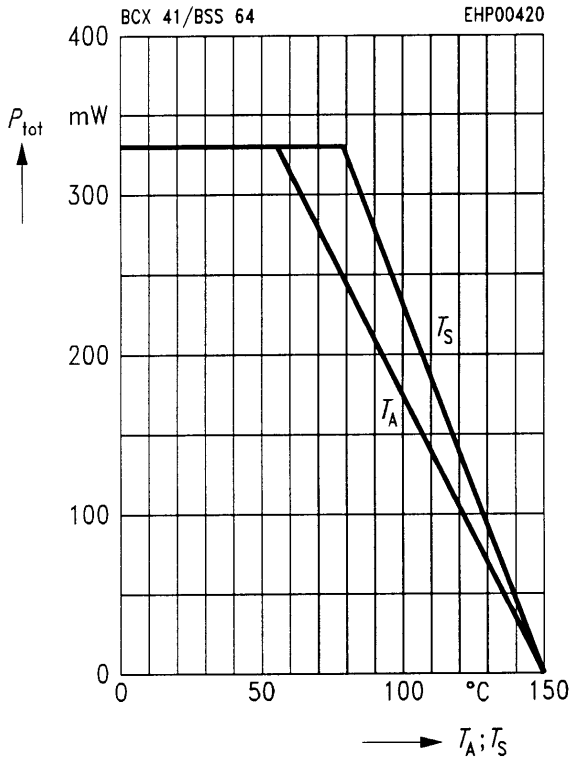

Collector current $I_C = f(V_{BE})$

$V_{CE} = 1\text{ V}$

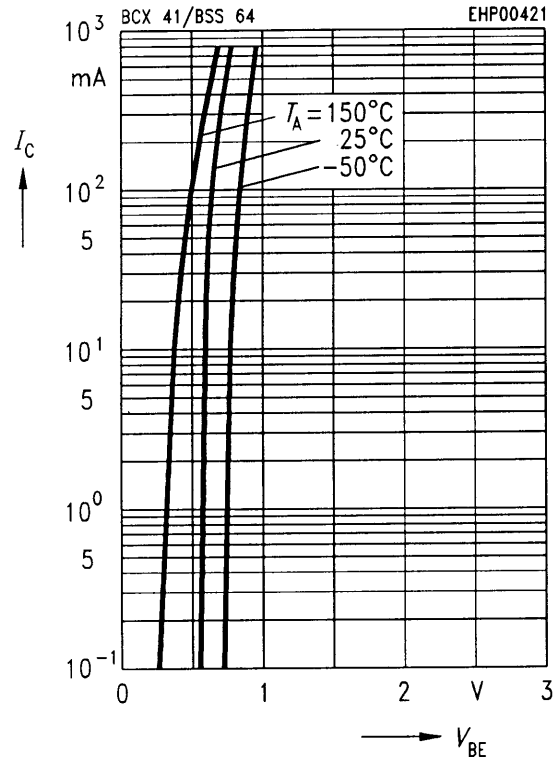

Permissible pulse load $P_{tot\ max}/P_{tot\ DC} = f(t_p)$

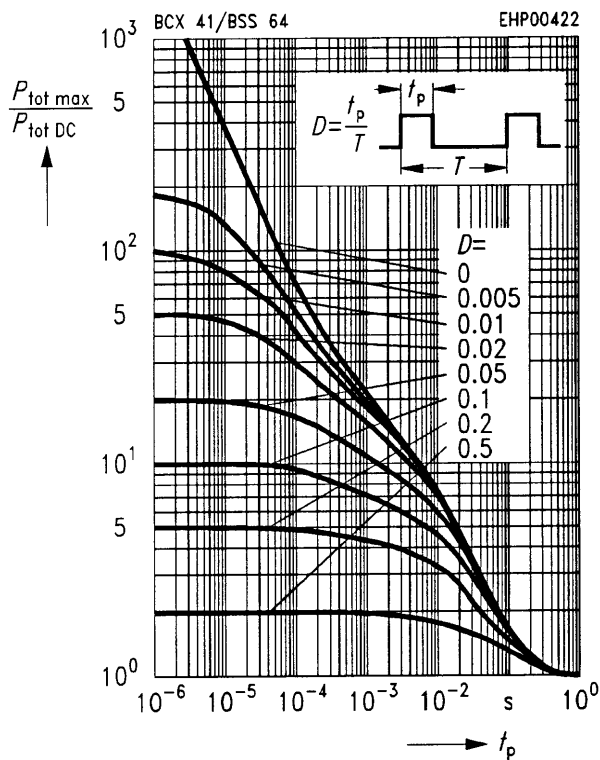

Transition frequency $f_T = f(I_C)$

$V_{CE} = 5\text{ V}$

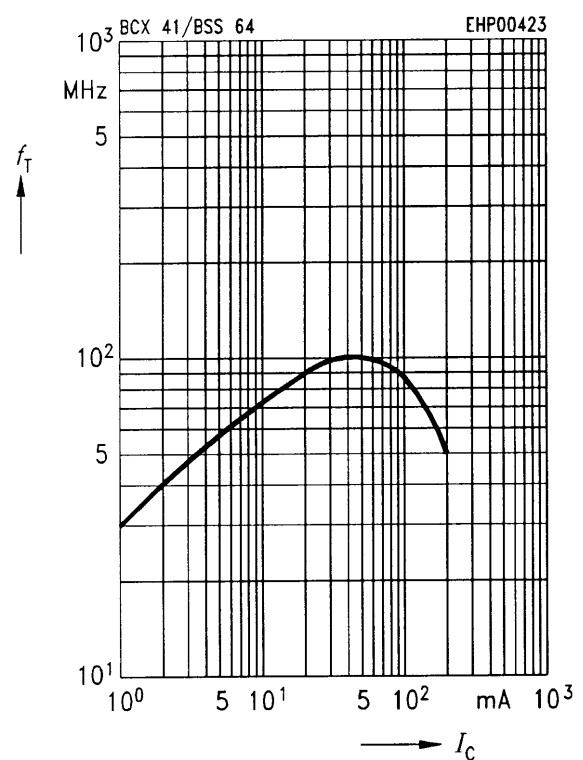

Base-emitter saturation voltage

$I_C = f(V_{BEsat})$

$h_{FE} = 10$

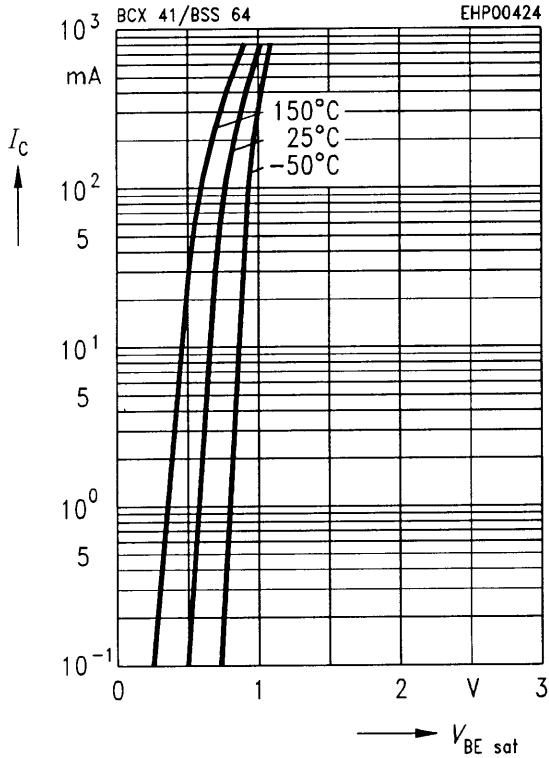

Collector-emitter saturation voltage

$I_C = f(V_{CEsat})$

$h_{FE} = 10$

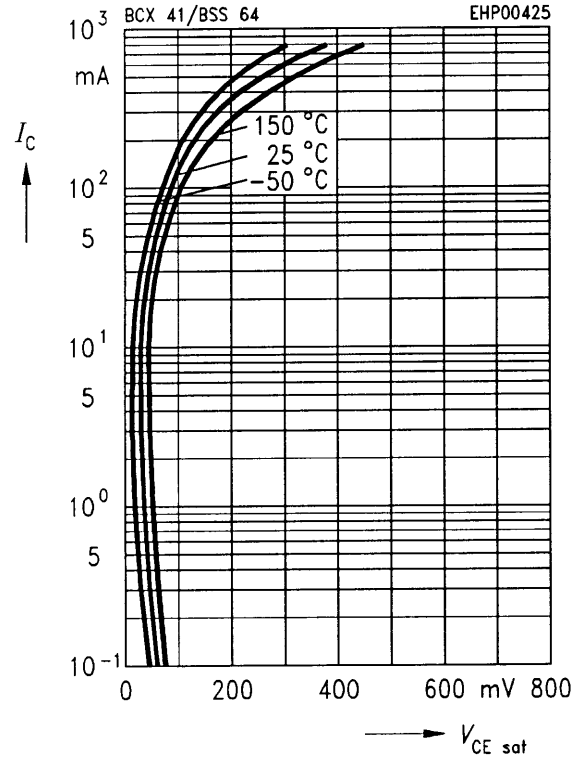

Collector cutoff current $I_{CB0} = f(T_A)$

$V_{CB} = V_{CE max}$

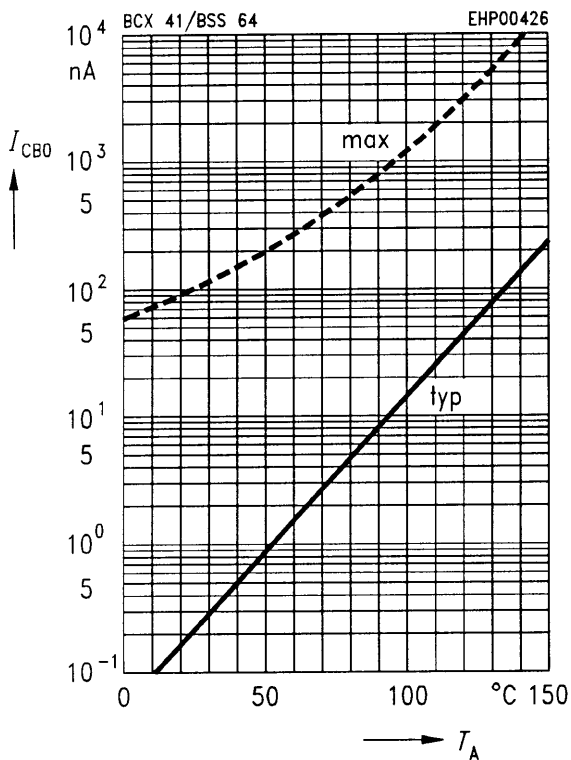

DC current gain $h_{FE} = f(I_C)$

$V_{CE} = 1 V$

