

## 3 AMP SOFT GLASS PASSIVATED SILICON DIODES

### FEATURES

- PROPRIETARY **SOFT GLASS<sup>®</sup>** JUNCTION PASSIVATION FOR SUPERIOR RELIABILITY AND PERFORMANCE
- VOID FREE VACUUM DIE SOLDERING FOR MAXIMUM MECHANICAL STRENGTH AND HEAT DISSIPATION (Solder Voids: Typical  $\leq 2\%$ , Max.  $\leq 10\%$  of Die Area)
- EXTREMELY LOW LEAKAGE AT HIGH TEMPERATURES
- LOW FORWARD VOLTAGE DROP
- 3A at  $T_A = 75^\circ\text{C}$  WITH NO THERMAL RUNAWAY

### MECHANICAL DATA

- Case: JEDEC DO-27 molded plastic (UL Flammability Rating 94V-0)
- Terminals: Plated axial leads
- Soldering: Per MIL-STD 202 Method 208 guaranteed
- Polarity: Color band denotes cathode
- Mounting Position: Any
- Weight: 0.02 Ounces (0.7 Grams)

### MECHANICAL SPECIFICATION

ACTUAL SIZE OF DO-27 PACKAGE

SERIES 1N5400G - 1N5408G

DO - 27

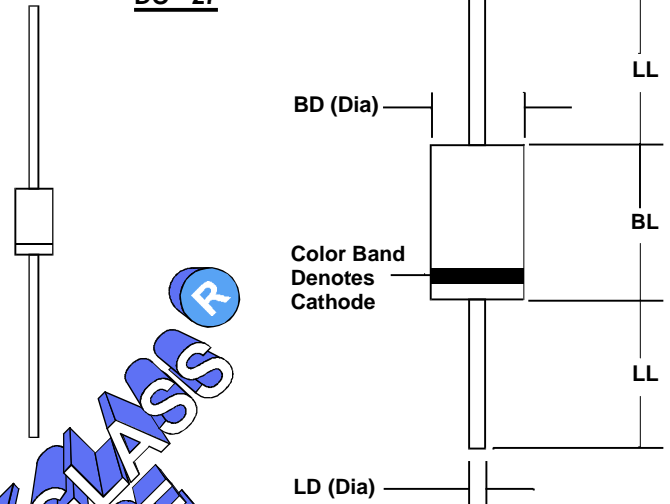

SOFT GLASS<sup>®</sup> DIODE

Sym	Minimum		Maximum	
	In	mm	In	mm
BL			0.365	9.28
BD			0.205	5.2
LL	1.00	25.4		
LD	0.048	1.2	0.052	1.3

### MAXIMUM RATINGS & ELECTRICAL CHARACTERISTICS

Ratings at 25 °C ambient temperature unless otherwise specified.  
 Single phase, half wave, 60Hz, resistive or inductive load.  
 For capacitive loads, derate current by 20%.

PARAMETER (TEST CONDITIONS)	SYMBOL	RATINGS							UNITS
		1N 5400G	1N 5401G	1N 5402G	1N 5404G	1N 5406G	1N 5407G	1N 5408G	
Maximum DC Blocking Voltage	$V_{RM}$	50	100	200	400	600	800	1000	VOLTS
Maximum RMS Voltage	$V_{RMS}$	35	70	140	280	420	560	700	
Maximum Peak Recurrent Reverse Voltage	$V_{RRM}$	50	100	200	400	600	800	1000	
Average Forward Rectified Current @ $T_A = 75^\circ\text{C}$ (Lead length = 0.375 in. (9.5 mm))	$I_o$	3							AMPS
Peak Forward Surge Current (8.3 mSec single half sine wave superimposed on rated load)	$I_{FSM}$	200							
Maximum Forward Voltage at 3 Amps DC	$V_{FM}$	1							VOLTS
Maximum Full Cycle Reverse Current @ $T_L = 75^\circ\text{C}$ (Note 1)	$I_{RM(AV)}$	20							$\mu\text{A}$
Maximum Average DC Reverse Current At Rated DC Blocking Voltage @ $T_A = 25^\circ\text{C}$ @ $T_A = 100^\circ\text{C}$	$I_{RM}$	2 50							
Typical Thermal Resistance, Junction to Ambient (Note 1)	$R_{\theta JA}$	18							$^\circ\text{C/W}$
Typical Junction Capacitance (Note 2)	$C_J$	70							pF
Operating and Storage Temperature Range	$T_J, T_{STG}$	-65 to +175							$^\circ\text{C}$

NOTES: (1) Lead length = 0.375 in. (9.5 mm)  
 (2) Measured at 1MHz & applied reverse voltage of 4 volts

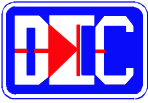

### 3 AMP SOFT GLASS PASSIVATED SILICON DIODES

#### RATING & CHARACTERISTIC CURVES FOR SERIES 1N5400G - 1N5408G

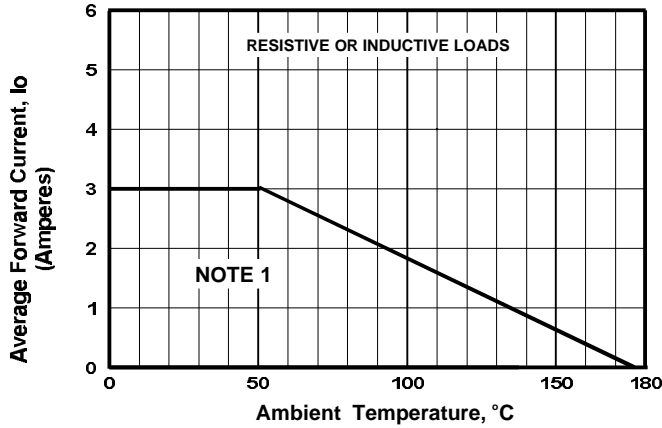

FIGURE 1. FORWARD CURRENT DERATING CURVE

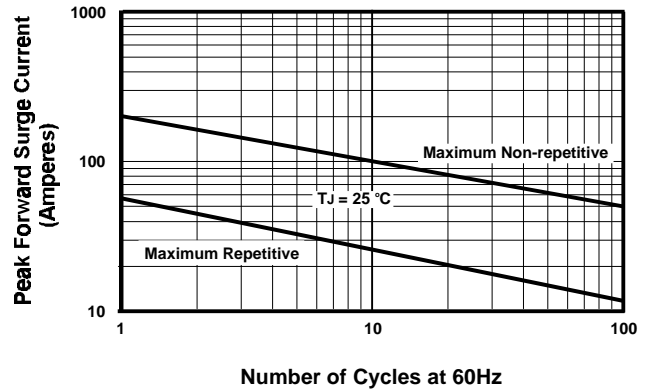

FIGURE 2. FORWARD SURGE CURRENT

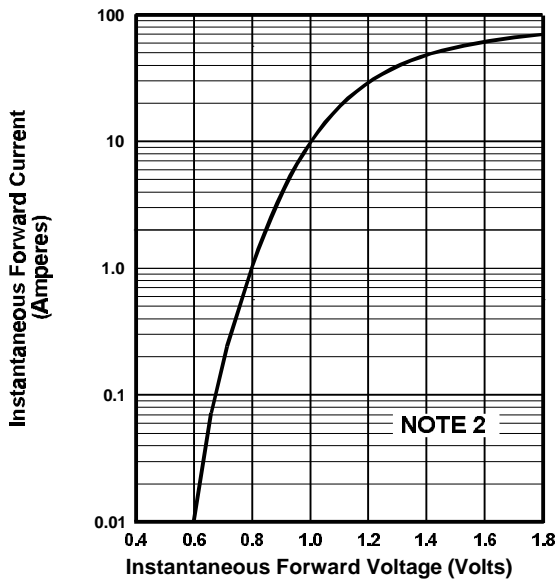

FIGURE 3. TYPICAL FORWARD CHARACTERISTICS

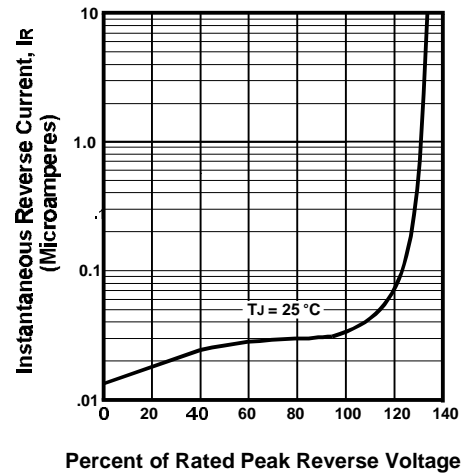

FIGURE 4. TYPICAL REVERSE CHARACTERISTICS

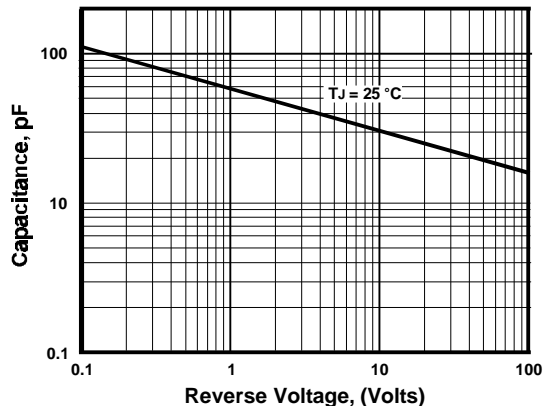

FIGURE 5. TYPICAL JUNCTION CAPACITANCE

**NOTES**

- (1) Single Phase, Half Wave, 60 Hz; Lead Length = 0.375" (9.5mm)
- (2) T<sub>J</sub> = 25 °C, Pulse Width = 300 μSec, 1.0% Duty Cycle