

FEATURES

Ultralow noise

0.9 nV/ $\sqrt{\text{Hz}}$

2.4 pA/ $\sqrt{\text{Hz}}$

1.2 nV/ $\sqrt{\text{Hz}}$ @ 10 Hz

Ultralow distortion: -93 dBc at 500 kHz

Wide supply voltage range: ± 5 V to ± 16 V

High speed

-3 dB bandwidth: 65 MHz (G = +1)

Slew rate: 55 V/ μs

Unity gain stable

Low input offset voltage: 150 μV maximum

Low input offset voltage drift: 1 $\mu\text{V}/^\circ\text{C}$

Low input bias current: -0.1 μA

Low input bias current drift: 2 nA/ $^\circ\text{C}$

Supply current: 8 mA

Power-down feature

APPLICATIONS

Instrumentation

Active filters

DAC buffers

SAR ADC drivers

Optoelectronics

GENERAL DESCRIPTION

The ADA4898-1 is an ultralow noise and distortion, unity gain stable, voltage feedback op amp that is ideal for use in 16-bit and 18-bit systems with power supplies from ± 5 V to ± 16 V. The ADA4898-1 features a linear, low noise input stage and internal compensation that achieves high slew rates and low noise.

With the wide supply voltage range, low offset voltage, and wide bandwidth, the ADA4898-1 is extremely versatile, and it features a cancellation circuit that reduces input bias current.

The ADA4898-1 is available in an 8-lead SOIC package that features an exposed metal paddle to improve power dissipation and heat transfer to the negative supply plane. This EPAD offers a significant thermal relief over traditional plastic packages. The ADA4898-1 is rated to work over the extended industrial temperature range of -40°C to $+105^\circ\text{C}$.

CONNECTION DIAGRAM

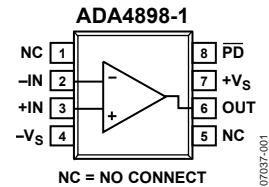

Figure 1. Single 8-Lead ADA4898-1 SOIC_N_EP (RD-8-1)

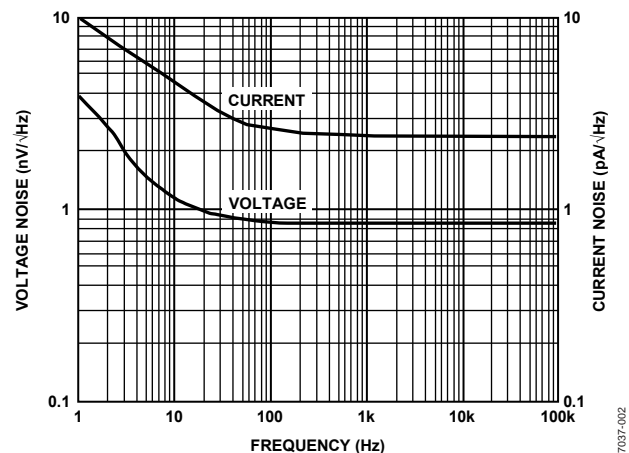

Figure 2. Input Voltage Noise and Current Noise vs. Frequency

Rev. B

Information furnished by Analog Devices is believed to be accurate and reliable. However, no responsibility is assumed by Analog Devices for its use, nor for any infringements of patents or other rights of third parties that may result from its use. Specifications subject to change without notice. No license is granted by implication or otherwise under any patent or patent rights of Analog Devices. Trademarks and registered trademarks are the property of their respective owners.

TABLE OF CONTENTS

Features	1	Theory of Operation	14
Applications.....	1	$\overline{\text{PD}}$ (Power-Down) Pin	14
Connection Diagram	1	Current Noise Measurement	14
General Description	1	0.1 Hz to 10 Hz Noise	15
Revision History	2	Applications Information	16
Specifications.....	3	Higher Feedback Resistor Gain Operation.....	16
± 15 V Supply.....	3	Recommended Values for Various Gains.....	16
± 5 V Supply	4	Noise	17
Absolute Maximum Ratings.....	5	Circuit Considerations	17
Thermal Resistance	5	PCB Layout	17
Maximum Power Dissipation	5	Power Supply Bypassing.....	17
ESD Caution.....	5	Grounding.....	17
Pin Configuration and Function Descriptions.....	6	Outline Dimensions	18
Typical Performance Characteristics	7	Ordering Guide	18
Test Circuits.....	13		

REVISION HISTORY

6/09—Rev. A to Rev. B

Changes to General Description Section	1
Changes to Specifications Section	3
Changes to Figure 29 and Figure 31	11
Added Figure 32.....	12
Added Figure 41.....	13
Changes to $\overline{\text{PD}}$ (Power-Down) Pin Section	14
Added Table 6.....	14
Changes to Figure 45.....	15

8/08—Rev. 0 to Rev. A

Changes to General Description Section	1
Changes to Table 5.....	6
Changes to Figure 17.....	9
Changes to Figure 28.....	10
Changes to Figure 29 and Figure 32.....	11
Added 0.1 Hz to 10 Hz Noise Section.....	14
Added Figure 42 and Figure 43; Renumbered Sequentially	14
Changes to Grounding Section.....	16
Updated Outline Dimensions	17

5/08—Revision 0: Initial Release

SPECIFICATIONS

±15 V SUPPLY

$T_A = 25^\circ\text{C}$, $G = +1$, $R_F = 0\ \Omega$, R_G open, $R_L = 1\ \text{k}\Omega$ to GND (for $G > 1$, $R_F = 100\ \Omega$), unless otherwise noted.

Table 1.

Parameter	Conditions	Min	Typ	Max	Unit
DYNAMIC PERFORMANCE					
–3 dB Bandwidth	$V_{OUT} = 100\ \text{mV p-p}$		65		MHz
	$V_{OUT} = 2\ \text{V p-p}$		14		MHz
Bandwidth for 0.1 dB Flatness	$G = +2$, $V_{OUT} = 2\ \text{V p-p}$		3.3		MHz
Slew Rate	$V_{OUT} = 5\ \text{V step}$		55		V/ μs
Settling Time to 0.1%	$V_{OUT} = 5\ \text{V step}$		85		ns
NOISE/DISTORTION PERFORMANCE					
Harmonic Distortion SFDR	$f = 100\ \text{kHz}$, $V_{OUT} = 2\ \text{V p-p}$		–116		dBc
	$f = 500\ \text{kHz}$, $V_{OUT} = 2\ \text{V p-p}$		–93		dBc
	$f = 1\ \text{MHz}$, $V_{OUT} = 2\ \text{V p-p}$		–79		dBc
Input Voltage Noise	$f = 100\ \text{kHz}$		0.9		nV/ $\sqrt{\text{Hz}}$
Input Current Noise	$f = 100\ \text{kHz}$		2.4		pA/ $\sqrt{\text{Hz}}$
DC PERFORMANCE					
	$R_F = 1\ \text{k}\Omega$				
Input Offset Voltage			20	120	μV
Input Offset Voltage Drift			1		$\mu\text{V}/^\circ\text{C}$
Input Bias Current			–0.1	–0.4	μA
Input Bias Offset Current			0.03	0.3	μA
Input Bias Current Drift			2		nA/ $^\circ\text{C}$
Open-Loop Gain	$V_{OUT} = \pm 5\ \text{V}$	99	103		dB
INPUT CHARACTERISTICS					
Input Resistance	Differential mode		5		k Ω
	Common mode		30		M Ω
Input Capacitance	Differential mode		3.2		pF
	Common mode		2.5		pF
Input Common-Mode Voltage Range	See Figure 41		± 11		V
Common-Mode Rejection Ratio	$\Delta V_{CM} = 2\ \text{V p-p}$	–103	–126		dB
PD (POWER-DOWN) PIN					
PD Input Voltages	Chip powered down		≤ -14		V
	Chip enabled		≥ -13		V
Input Leakage Current	$\overline{\text{PD}} = +V_S$		–0.1		μA
	$\overline{\text{PD}} = -V_S$		–0.2		μA
OUTPUT CHARACTERISTICS					
Output Voltage Swing	$R_L // (R_F + R_G) = 500\ \Omega$, see Figure 41	–11.4 to +11.8	–11.7 to +12.1		V
	$R_L // (R_F + R_G) = 1\ \text{k}\Omega$, see Figure 41	–12.7 to +12.5	–12.8 to +12.7		V
Linear Output Current (RMS)	$f = 100\ \text{kHz}$, SFDR = –70 dBc, $R_L = 150\ \Omega$		40		mA
Short-Circuit Current	Sinking/sourcing		150		mA
Off Isolation	$f = 1\ \text{MHz}$, $\overline{\text{PD}} = -V_S$		80		dB
POWER SUPPLY					
Operating Range		± 4.5		± 16.5	V
Quiescent Current	$\overline{\text{PD}} = +V_S$		8.1	8.7	mA
	$\overline{\text{PD}} = -V_S$		0.1	0.3	mA
Positive Power Supply Rejection Ratio	$+V_S = 15\ \text{V}$ to $17\ \text{V}$, $-V_S = -15\ \text{V}$	–98	–107		dB
Negative Power Supply Rejection Ratio	$+V_S = 15\ \text{V}$, $-V_S = -15\ \text{V}$ to $-17\ \text{V}$	–100	–114		dB

ADA4898-1

±5 V SUPPLY

$T_A = 25^\circ\text{C}$, $G = +1$, $R_F = 0\ \Omega$, R_G open, $R_L = 1\ \text{k}\Omega$ to GND (for $G > 1$, $R_F = 100\ \Omega$), unless otherwise noted.

Table 2.

Parameter	Conditions	Min	Typ	Max	Unit
DYNAMIC PERFORMANCE					
-3 dB Bandwidth	$V_{OUT} = 100\ \text{mV p-p}$		57		MHz
	$V_{OUT} = 2\ \text{V p-p}$		12		MHz
Bandwidth for 0.1 dB Flatness	$G = +2$, $V_{OUT} = 2\ \text{V p-p}$		3		MHz
Slew Rate	$V_{OUT} = 2\ \text{V step}$		50		V/ μs
Settling Time to 0.1%	$V_{OUT} = 2\ \text{V step}$		90		ns
NOISE/DISTORTION PERFORMANCE					
Harmonic Distortion SFDR	$f = 500\ \text{kHz}$, $V_{OUT} = 2\ \text{V p-p}$		-95		dBc
	$f = 1\ \text{MHz}$, $V_{OUT} = 2\ \text{V p-p}$		-78		dBc
Input Voltage Noise	$f = 100\ \text{kHz}$		0.9		nV/ $\sqrt{\text{Hz}}$
Input Current Noise	$f = 100\ \text{kHz}$		2.4		pA/ $\sqrt{\text{Hz}}$
DC PERFORMANCE					
Input Offset Voltage			30	150	μV
Input Offset Voltage Drift			1		$\mu\text{V}/^\circ\text{C}$
Input Bias Current			-0.1	-0.5	μA
Input Bias Offset Current			0.01	0.3	μA
Input Bias Current Drift			2		nA/ $^\circ\text{C}$
Open-Loop Gain	$V_{OUT} = \pm 1\ \text{V}$	90	94		dB
INPUT CHARACTERISTICS					
Input Resistance	Differential mode		5		k Ω
	Common mode		30		M Ω
Input Capacitance	Differential mode		3.2		pF
	Common mode		2.5		pF
Input Common-Mode Voltage Range	See Figure 41		-3 to +2.5		V
Common-Mode Rejection Ratio	$\Delta V_{CM} = 1\ \text{V p-p}$	-102	-120		dB
PD (POWER-DOWN) PIN					
PD Input Voltages	Chip powered down		≤ -4		V
	Chip enabled		≥ -3		V
Input Leakage Current	$\overline{\text{PD}} = +V_S$		0.1		μA
	$\overline{\text{PD}} = -V_S$		-2		μA
OUTPUT CHARACTERISTICS					
Output Voltage Swing	$R_L // (R_F + R_G) = 500\ \Omega$, see Figure 41	± 3.1	± 3.2		V
	$R_L // (R_F + R_G) = 1\ \text{k}\Omega$, see Figure 41	± 3.3	± 3.4		V
Linear Output Current (RMS)	$f = 100\ \text{kHz}$, SFDR = -70 dBc, $R_L = 150\ \Omega$		8		mA
Short-Circuit Current	Sinking/sourcing		150		mA
Off Isolation	$f = 1\ \text{MHz}$, $\overline{\text{PD}} = -V_S$		80		dB
POWER SUPPLY					
Operating Range		± 4.5		± 16.5	V
Quiescent Current	$\overline{\text{PD}} = +V_S$		7.7	8.4	mA
	$\overline{\text{PD}} = -V_S$		0.1	0.2	mA
Positive Power Supply Rejection Ratio	$+V_S = 5\ \text{V to } 7\ \text{V}$, $-V_S = -5\ \text{V}$	-95	-100		dB
Negative Power Supply Rejection Ratio	$+V_S = 5\ \text{V}$, $-V_S = -5\ \text{V to } -7\ \text{V}$	-97	-104		dB

ABSOLUTE MAXIMUM RATINGS

Table 3.

Parameter	Rating
Supply Voltage	36 V
Power Dissipation	See Figure 3
Differential Mode Input Voltage	±1.5 V
Common-Mode Input Voltage	±11.4 V
Storage Temperature Range	−65°C to +150°C
Operating Temperature Range	−40°C to +105°C
Lead Temperature (Soldering, 10 sec)	300°C
Junction Temperature	150°C

Stresses above those listed under Absolute Maximum Ratings may cause permanent damage to the device. This is a stress rating only; functional operation of the device at these or any other conditions above those indicated in the operational section of this specification is not implied. Exposure to absolute maximum rating conditions for extended periods may affect device reliability.

THERMAL RESISTANCE

θ_{JA} is specified for the worst-case conditions, that is, θ_{JA} is specified for a device soldered in the circuit board with its exposed paddle soldered to a pad on the PCB surface that is thermally connected to a copper plane, with zero airflow.

Table 4.

Package Type	θ_{JA}	θ_{JC}	Unit
8-Lead SOIC_N_EP on 4-Layer Board (Single)	47	29	°C/W

MAXIMUM POWER DISSIPATION

The maximum safe power dissipation in the ADA4898-1 package is limited by the associated rise in junction temperature (T_J) on the die. At approximately 150°C, which is the glass transition temperature, the plastic changes its properties. Even temporarily exceeding this temperature limit can change the stresses that the package exerts on the die, permanently shifting the parametric performance of the ADA4898-1. Exceeding a junction temperature of 150°C for an extended period can result in changes in the silicon devices, potentially causing failure.

The power dissipated in the package (P_D) is the sum of the quiescent power dissipation and the power dissipated in the package due to the output load drive. The quiescent power is the voltage between the supply pins (V_S) times the quiescent current (I_S). The power dissipated due to the load drive depends upon the particular application. For each output, the power due to load drive is calculated by multiplying the load current by the associated voltage drop across the device. RMS voltages and currents must be used in these calculations.

Airflow increases heat dissipation, effectively reducing θ_{JA} . In addition, more metal directly in contact with the package leads from metal traces, through holes, ground, and power planes reduces the θ_{JA} . The exposed paddle on the underside of the package must be soldered to a pad on the PCB surface that is thermally connected to a copper plane to achieve the specified θ_{JA} .

Figure 3 shows the maximum power dissipation in the package for the ADA4898-1 vs. the ambient temperature for the 8-lead SOIC_N_EP on a JEDEC standard 4-layer board, with its underside paddle soldered to a pad that is thermally connected to a PCB plane. θ_{JA} values are approximations.

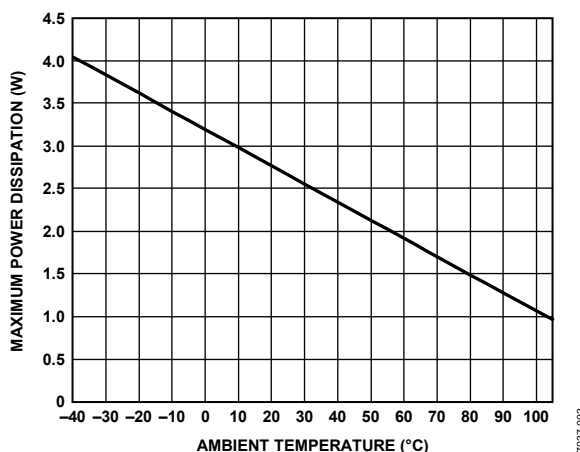

Figure 3. Maximum Power Dissipation vs. Ambient Temperature

ESD CAUTION



ESD (electrostatic discharge) sensitive device. Charged devices and circuit boards can discharge without detection. Although this product features patented or proprietary protection circuitry, damage may occur on devices subjected to high energy ESD. Therefore, proper ESD precautions should be taken to avoid performance degradation or loss of functionality.

ADA4898-1

PIN CONFIGURATION AND FUNCTION DESCRIPTIONS

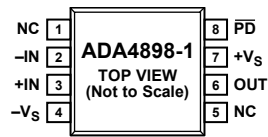

NOTES
1. NC = NO CONNECT.
2. EXPOSED PAD (EP) CAN BE CONNECTED TO -Vs OR LEFT FLOATING.

07037-046

Figure 4. Single 8-Lead SOIC_N_EP Pin Configuration

Table 5. Pin Function Descriptions

Pin No.	Mnemonic	Description
1	NC	No Connect.
2	-IN	Inverting Input.
3	+IN	Noninverting Input.
4	-Vs	Negative Supply.
5	NC	No Connect.
6	OUT	Output.
7	+Vs	Positive Supply.
8	$\overline{\text{PD}}$	Power Down.
EP	-Vs	Exposed Pad. Can be connected to negative supply (-Vs) or can be left floating.

TYPICAL PERFORMANCE CHARACTERISTICS

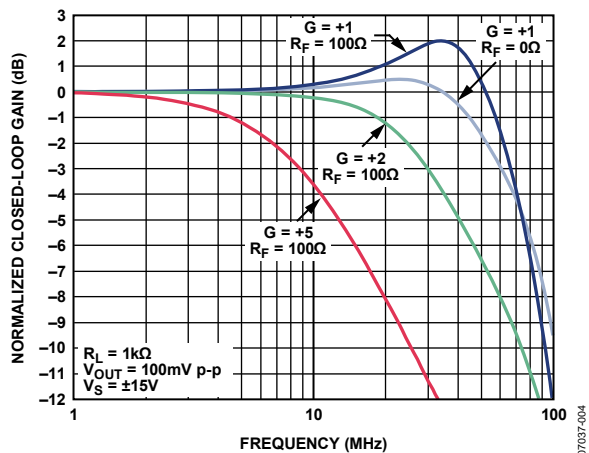

Figure 5. Small Signal Frequency Response for Various Gains

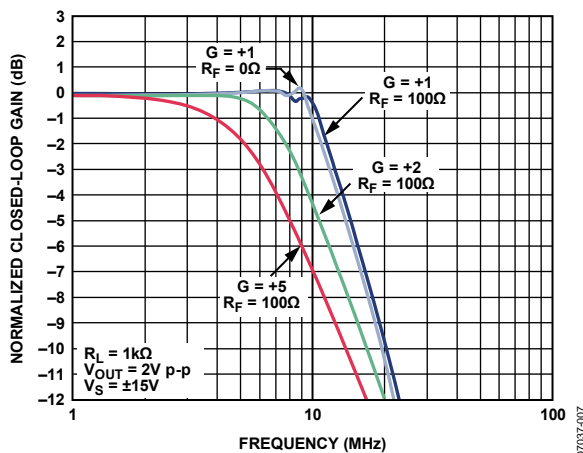

Figure 8. Large Signal Frequency Response for Various Gains

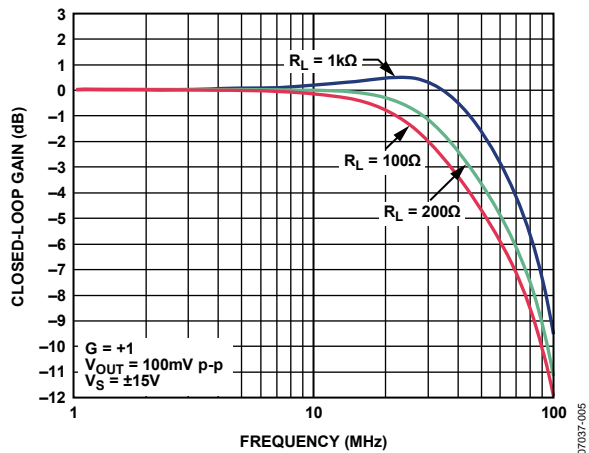

Figure 6. Small Signal Frequency Response for Various Loads

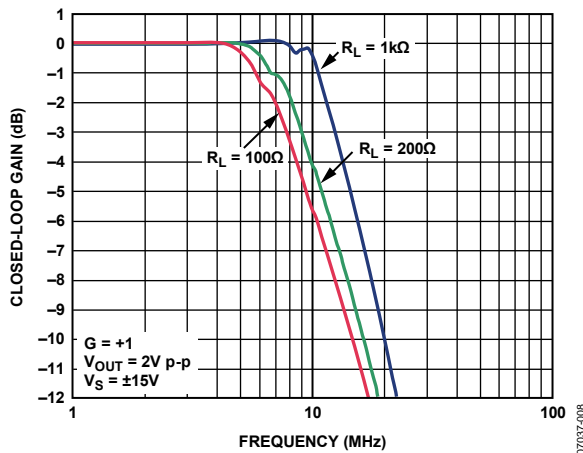

Figure 9. Large Signal Frequency Response for Various Loads

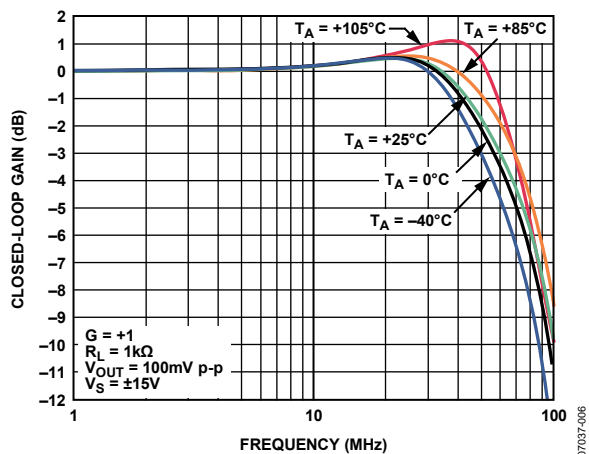

Figure 7. Small Signal Frequency Response for Various Temperatures

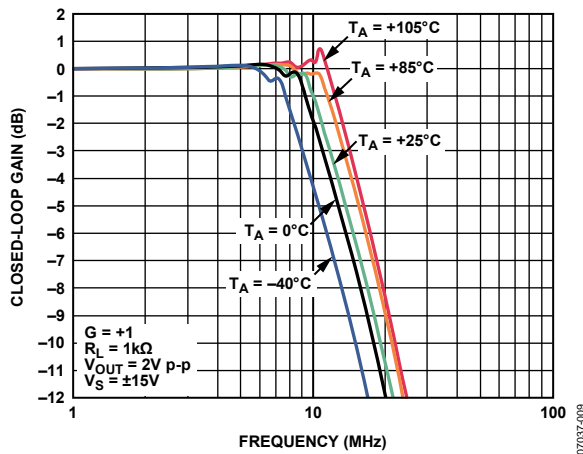

Figure 10. Large Signal Frequency Response for Various Temperatures

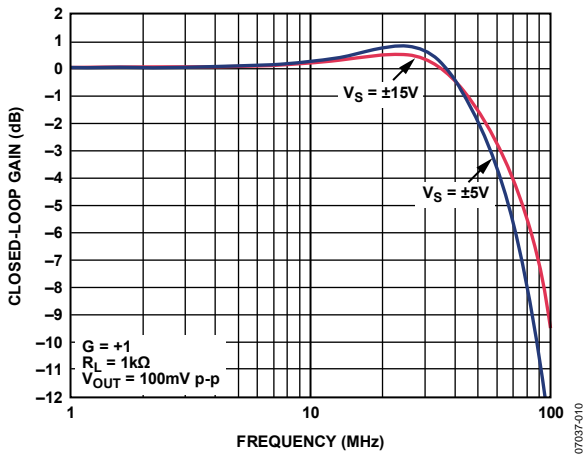

Figure 11. Small Signal Frequency Response for Various Supply Voltages

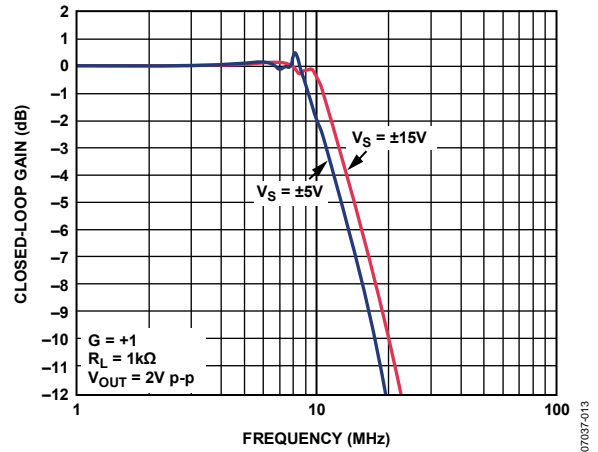

Figure 14. Large Signal Frequency Response for Various Supply Voltages

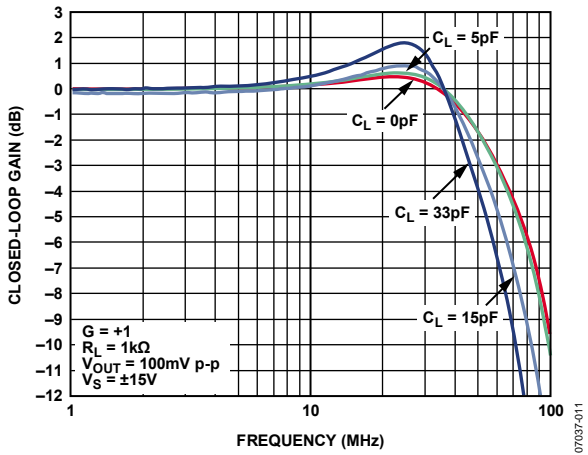

Figure 12. Small Signal Frequency Response for Various Capacitive Loads

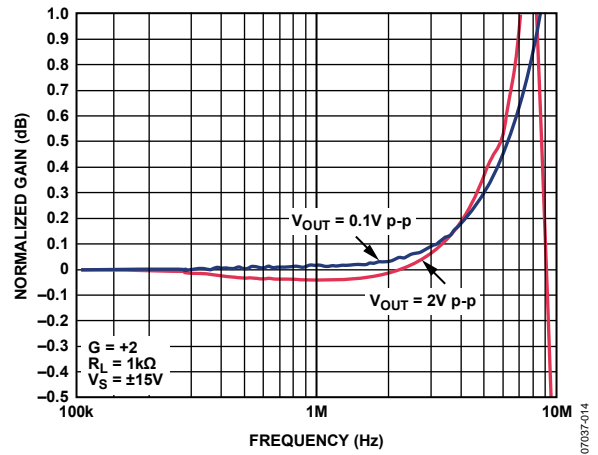

Figure 15. 0.1 dB Flatness for Various Output Voltages

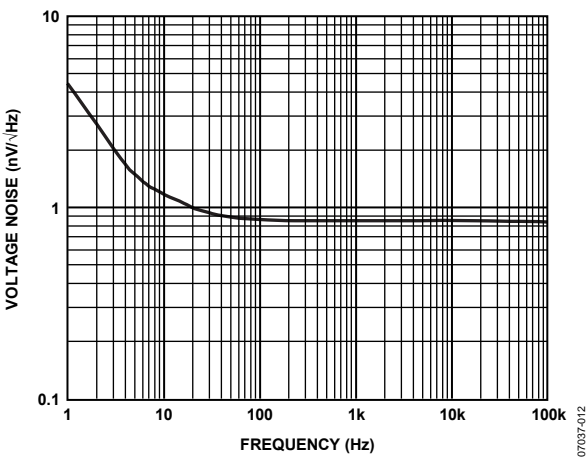

Figure 13. Voltage Noise vs. Frequency

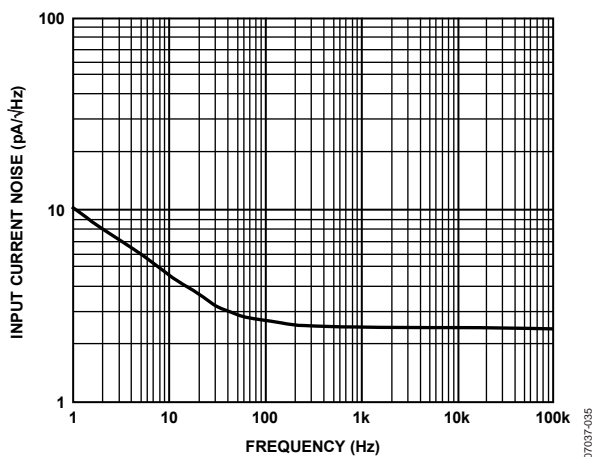

Figure 16. Input Current Noise vs. Frequency

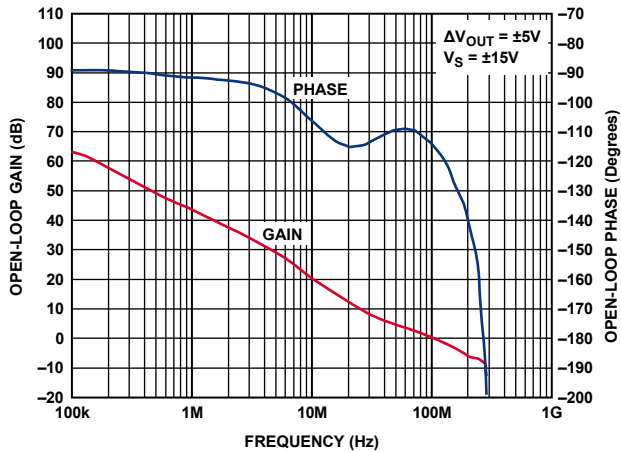

Figure 17. Open-Loop Gain and Phase vs. Frequency

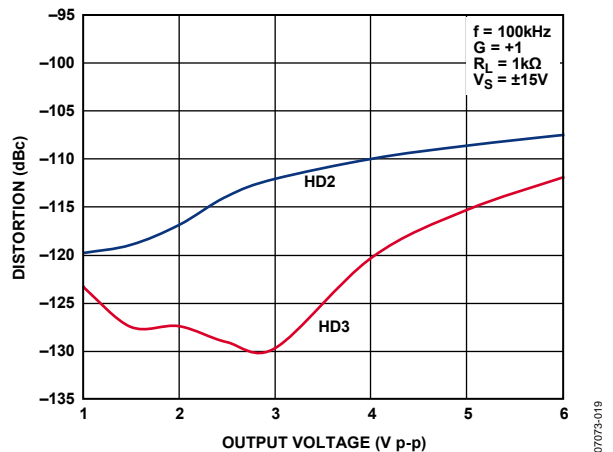

Figure 20. Harmonic Distortion vs. Output Amplitude

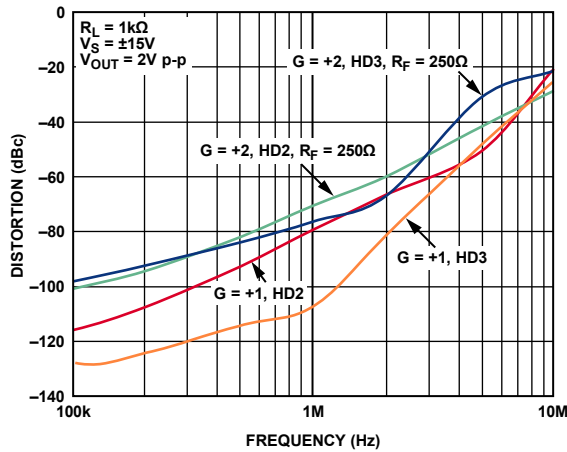

Figure 18. Harmonic Distortion vs. Frequency and Gain

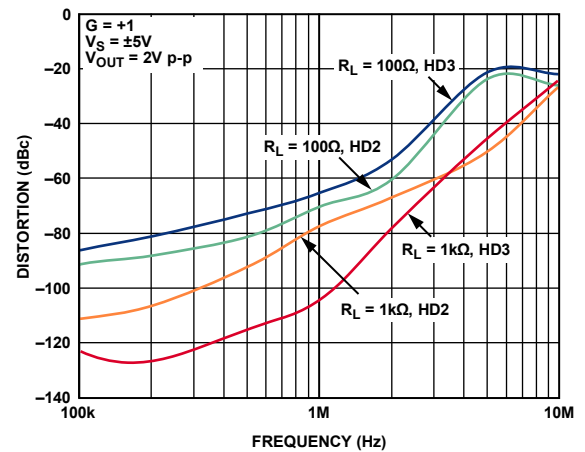

Figure 21. Harmonic Distortion vs. Frequency and Loads

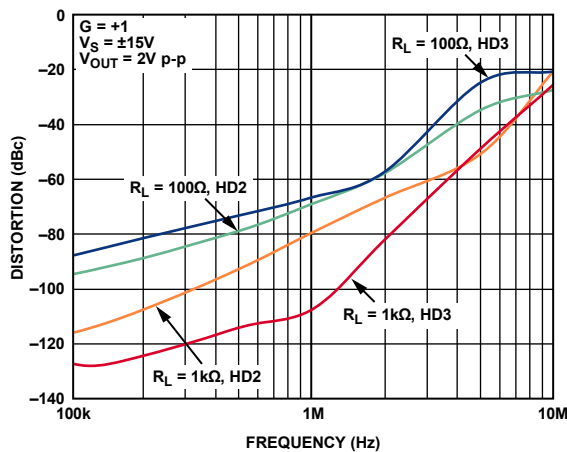

Figure 19. Harmonic Distortion vs. Frequency and Loads

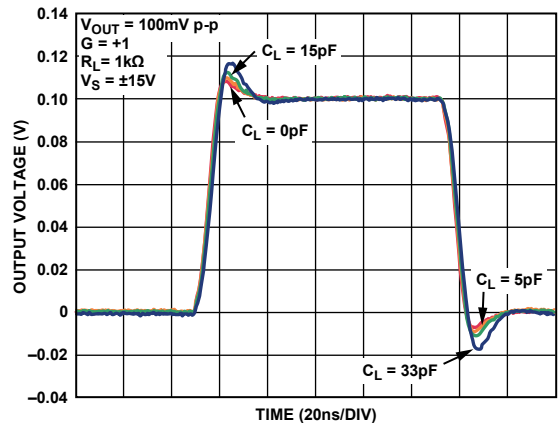

Figure 22. Small Signal Transient Response for Various Capacitive Loads

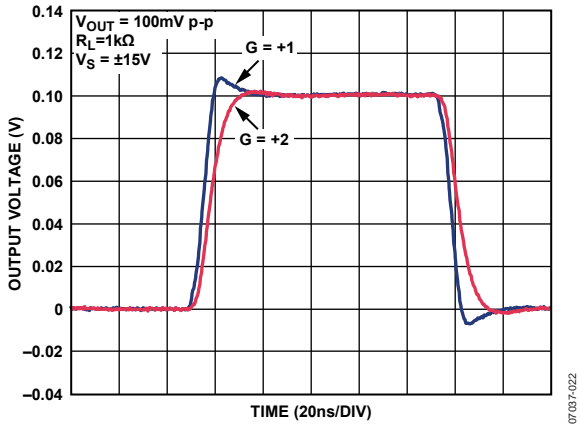

Figure 23. Small Signal Transient Response for Various Gains

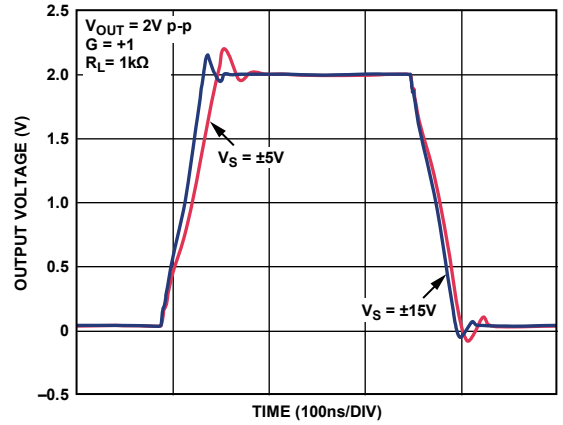

Figure 26. Large Signal Transient Response for Various Supply Voltages, $R_L = 1\text{k}\Omega$

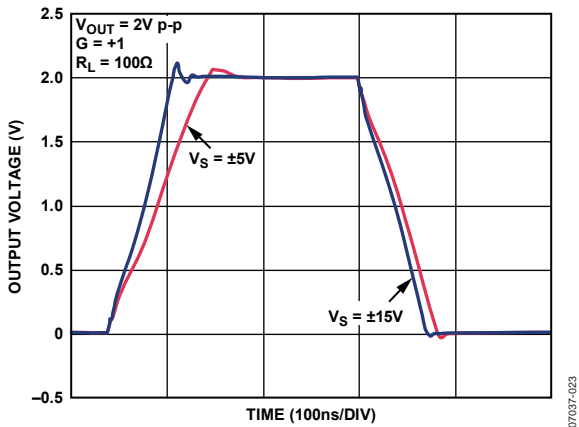

Figure 24. Large Signal Transient Response for Various Supply Voltages, $R_L = 100\Omega$

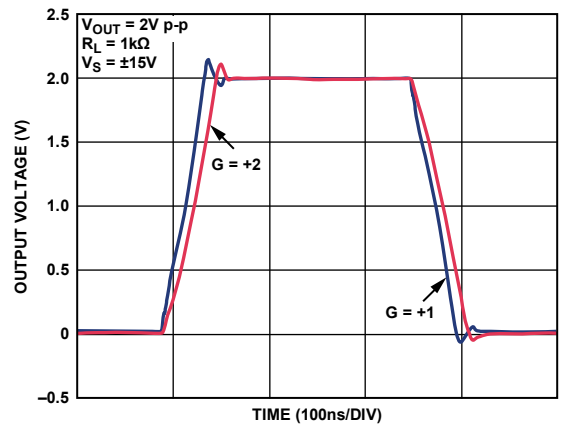

Figure 27. Large Signal Transient Response for Various Gains

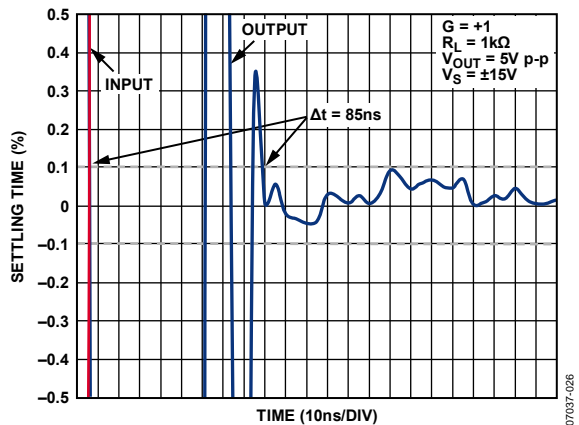

Figure 25. Settling Time

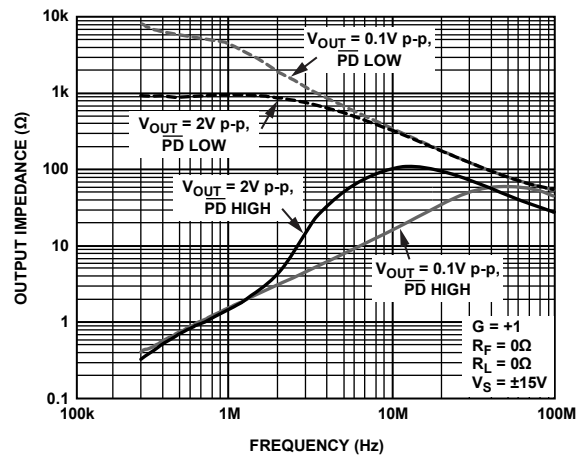

Figure 28. Output Impedance vs. Frequency

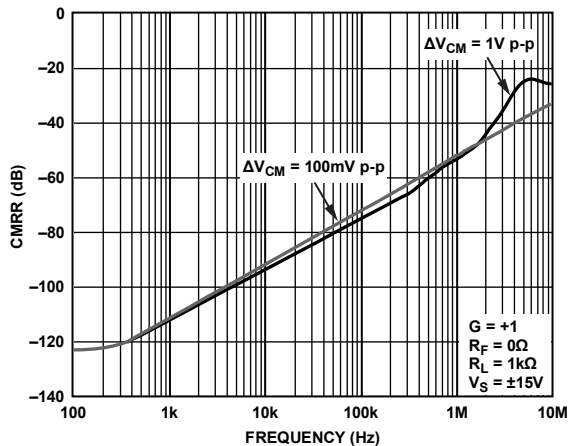

Figure 29. Common-Mode Rejection Ratio (CMRR) vs. Frequency

07037-029

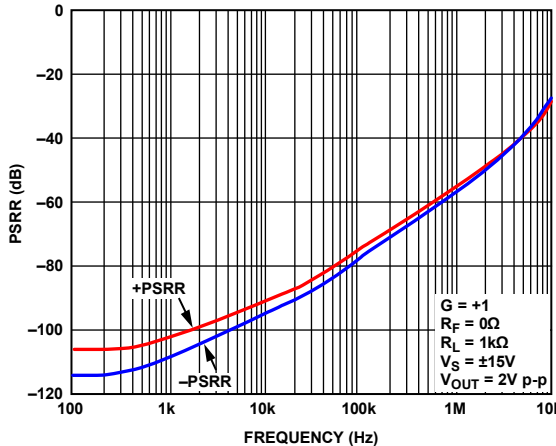

Figure 31. Power Supply Rejection Ratio (PSRR) vs. Frequency

07037-030

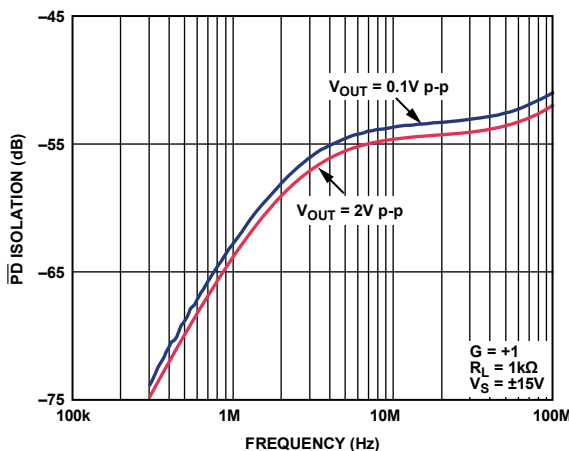

Figure 30. PD Isolation vs. Frequency

07037-031

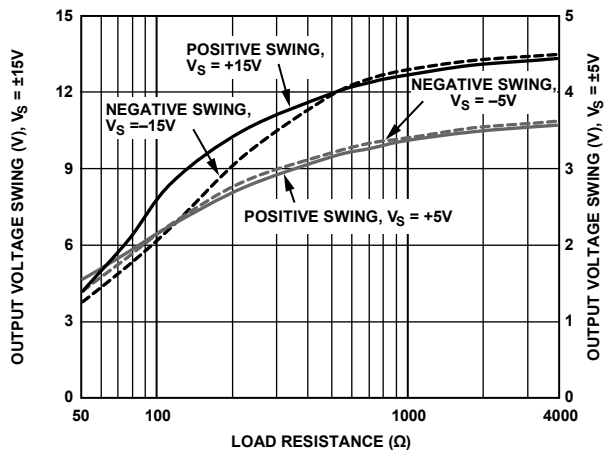

Figure 32 Output Swing vs. Load, $G = +2$, $Load = R_L // (R_F + R_C)$

07037-100

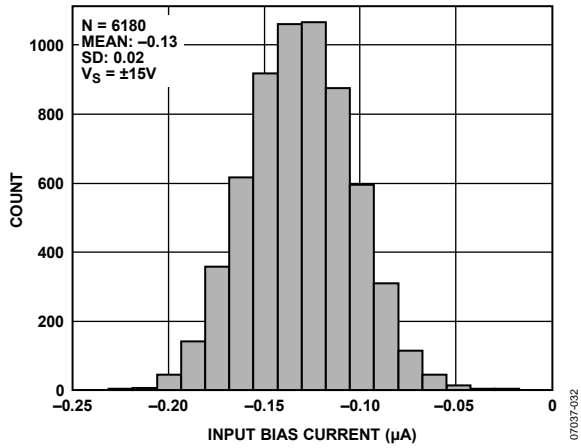

Figure 33. Input Bias Current Distribution

07037-032

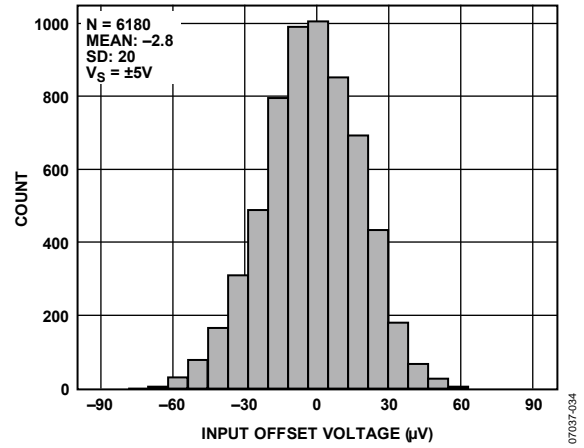

Figure 35. Input Offset Voltage Distribution, $V_S = \pm 5V$

07037-034

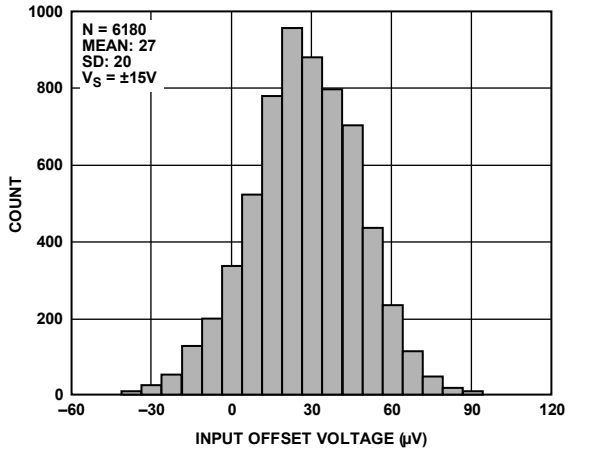
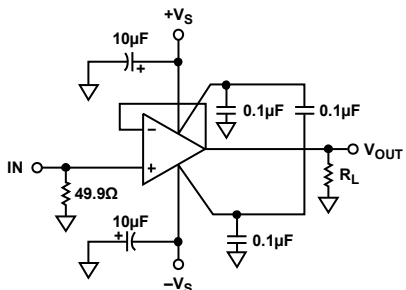

Figure 34. Input Offset Voltage Distribution, $V_S = \pm 15V$

07037-033

TEST CIRCUITS



07037-052

Figure 36. Typical Noninverting Load Configuration

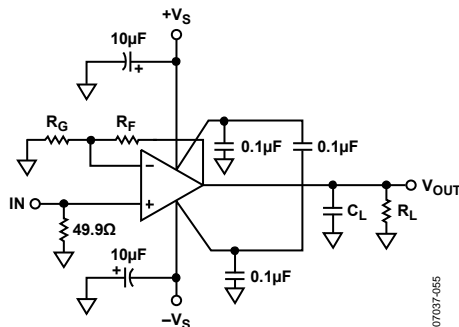

07037-055

Figure 39. Typical Capacitive Load Configuration

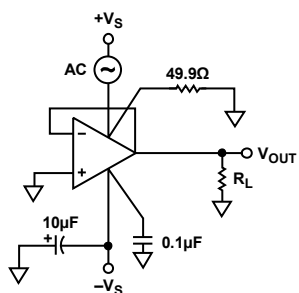

07037-053

Figure 37. Positive Power Supply Rejection

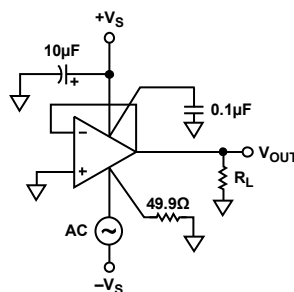

07037-056

Figure 40. Negative Power Supply Rejection

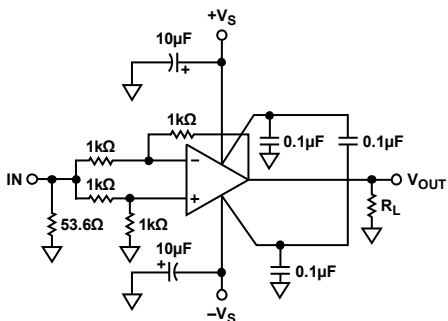

07037-054

Figure 38. Common-Mode Rejection

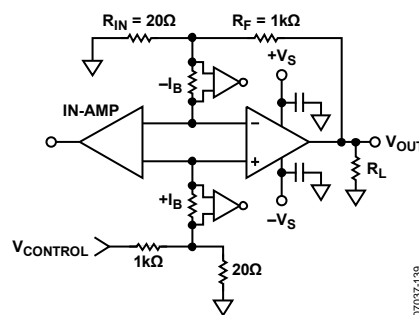

07037-139

Figure 41. DC Test Circuit

THEORY OF OPERATION

The ADA4898-1 is a voltage feedback op amp that combines unity gain stability with 0.9 nV/√Hz input noise. It employs a highly linear input stage that can maintain greater than -90 dBc (at 2 V p-p) distortion out to 500 kHz while in a unity-gain configuration. This rare combination of low gain stability, low input-referred noise, and extremely low distortion is the result of Analog Devices, Inc., proprietary op amp architecture and high voltage bipolar processing technology.

The simplified ADA4898-1 topology, shown in Figure 42, is a single gain stage with a unity gain output buffer. It has over 100 dB of open-loop gain and maintains precision specifications, such as CMRR, PSRR, and offset, to levels that are normally associated with topologies having two or more gain stages.

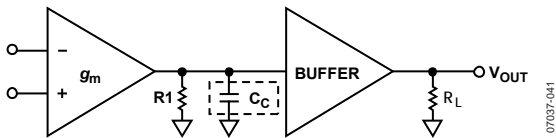

Figure 42. Topology

$\overline{\text{PD}}$ (POWER-DOWN) PIN

The $\overline{\text{PD}}$ pin saves power by decreasing the quiescent power dissipated in the device. It is very useful when power is an issue and the device does not need to be turned on at all times. The response of the device is rapid when going from power-down mode to full power operation mode. Note that $\overline{\text{PD}}$ does not put the output in a high-Z state, which means that the ADA4898-1 is not recommended for use as a multiplexer. Leaving the $\overline{\text{PD}}$ pin floating keeps the amplifier in full power operation mode.

Table 6. Power-Down Voltage Control

PD Pin	±15 V	±10 V	±5 V
Power-Down Mode	<-14 V	<-9 V	<-4 V
Full Power Mode	>-13 V	>-8 V	>-3 V

CURRENT NOISE MEASUREMENT

To measure the very low (2.4 pA/√Hz) input current noise of the ADA4898-1, 10 kΩ resistors were used on both inputs of the amplifier. Figure 43 shows the noise measurement circuit used. The 10 kΩ resistors are used on both inputs to balance the input impedance and cancel the common-mode noise. In addition, a high gain configuration is used to increase the total output noise and bring it above the noise floor of the instrument.

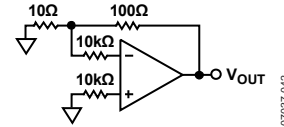

Figure 43. Current Noise Measurement Circuit

The current noise density (I_n) is calculated by

$$I_n = \frac{\left[e_{no}^2 - (11 \times 18.4 \text{ nV}/\sqrt{\text{Hz}})^2 \right]^{1/2} \times \sqrt{2}}{20 \text{ k}\Omega \times 11}$$

0.1 Hz TO 10 Hz NOISE

Figure 44 shows the 0.1 Hz to 10 Hz voltage and current noise of the ADA4898-1. The peak-to-peak noise voltage is below $0.5 \mu\text{V}$. Figure 45 shows the circuit used to measure the low frequency noise. It uses a band-pass filter of approximately 0.1 Hz and 10 Hz and a high gain stage feeding into an instrumentation amplifier.

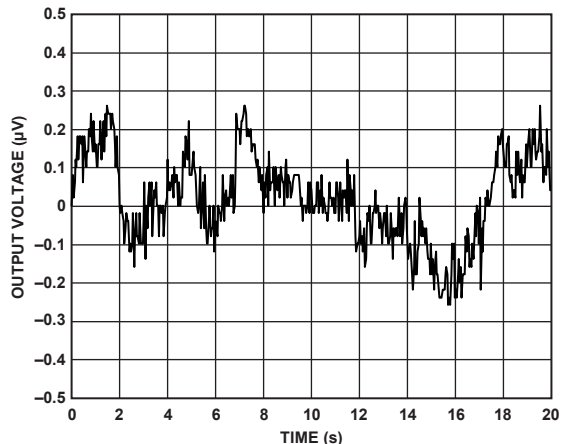

Figure 44. 0.1 Hz to 10 Hz Noise

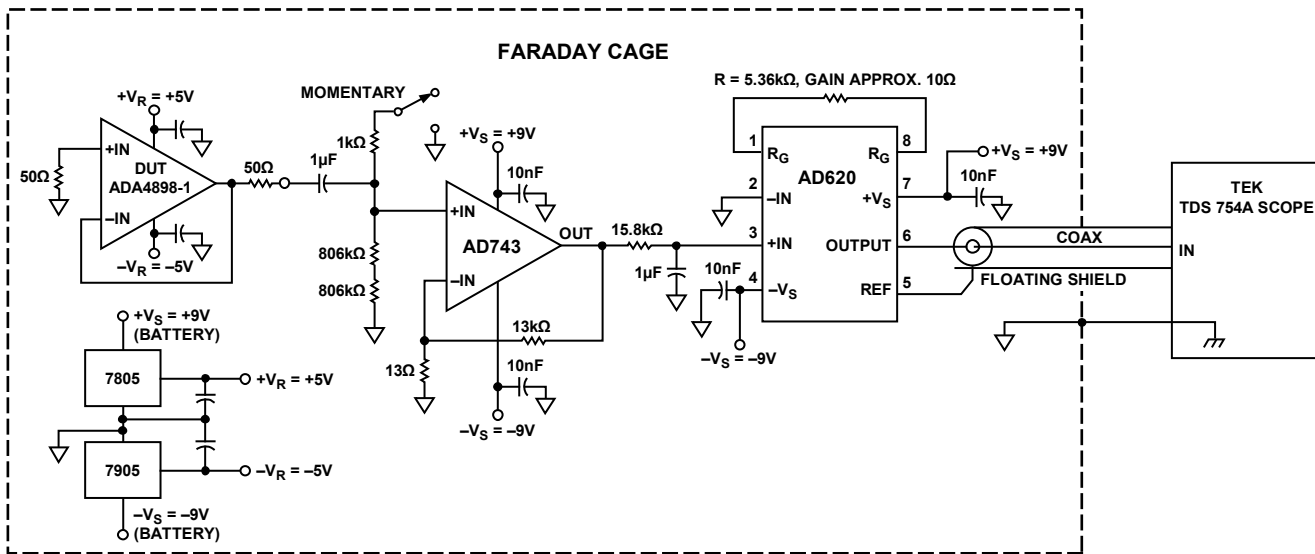

Figure 45. Low Frequency Noise Circuit

APPLICATIONS INFORMATION

HIGHER FEEDBACK RESISTOR GAIN OPERATION

The ADA4898-1 schematic for the noninverting gain configuration is nearly a textbook example (see Figure 46). The only exception is the feedback capacitor in parallel with the feedback resistor, R_F , but this capacitor is recommended only when using a large R_F value ($>300 \Omega$). Figure 47 shows the difference between using a 100Ω resistor and a $1 \text{ k}\Omega$ resistor. Due to the input capacitance in the ADA4898-1 when using a higher feedback resistor, more peaking appears in the closed-loop gain. Using the lower feedback resistor resolves this issue; however, when running at higher supplies ($\pm 15 \text{ V}$) with an R_F of 100Ω , the system draws extra current into the feedback network. To avoid this problem, a higher feedback resistor can be used with a feedback capacitor in parallel. Figure 47 also shows the effect of placing a feedback capacitor in parallel with a larger R_F . In this gain-of-2 configuration, $R_F = R_G = 1 \text{ k}\Omega$ and $C_F = 2.7 \text{ pF}$. When using C_F , the peaking drops from 6 dB to less than 2 dB.

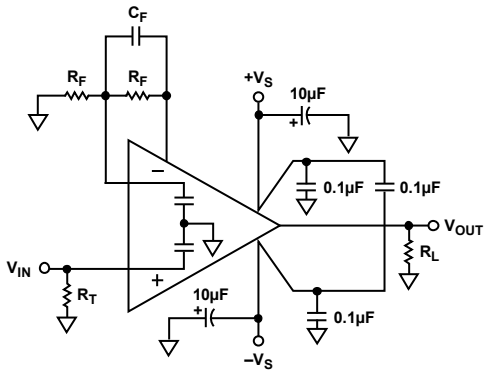

Figure 46. Noninverting Gain Schematic

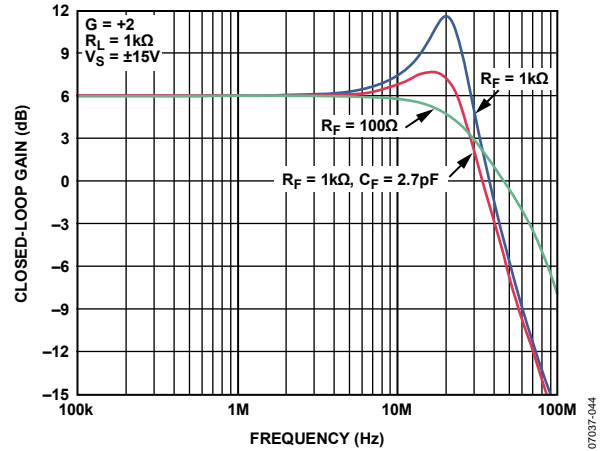

Figure 47. Small Signal Frequency Response for Various Feedback Impedances

RECOMMENDED VALUES FOR VARIOUS GAINS

Table 7 provides a useful reference for determining various gains and associated performance. R_F is set to 100Ω for gains greater than 1. A low feedback R_F resistor value reduces peaking and minimizes the contribution to the overall noise performance of the amplifier.

Table 7. Various Gains and Associated Recommended Resistor Values (Conditions: $V_S = \pm 5 \text{ V}$, $T_A = 25^\circ\text{C}$, $R_L = 1 \text{ k}\Omega$, $R_T = 49.9 \Omega$)

Gain	R_F (Ω)	R_G (Ω)	-3 dB SS BW (MHz), $V_{OUT} = 100 \text{ mV p-p}$	Slew Rate ($\text{V}/\mu\text{s}$), $V_{OUT} = 2 \text{ V Step}$	ADA4898-1 Voltage Noise ($\text{nV}/\sqrt{\text{Hz}}$), RTO	Total System Noise ($\text{nV}/\sqrt{\text{Hz}}$), RTO
+1	0	N/A	65	55	0.9	1.29
+2	100	100	30	50	1.8	3.16
+5	100	24.9	9	45	4.5	7.07

NOISE

To analyze the noise performance of an amplifier circuit, identify the noise sources, and then determine if each source has a significant contribution to the overall noise performance of the amplifier. To simplify the noise calculations, noise spectral densities were used rather than actual voltages to leave bandwidth out of the expressions. Noise spectral density, which is generally expressed in nV/ $\sqrt{\text{Hz}}$, is equivalent to the noise in a 1 Hz bandwidth.

The noise model shown in Figure 48 has six individual noise sources: the Johnson noise of the three resistors, the op amp voltage noise, and the current noise in each input of the amplifier. Each noise source has its own contribution to the noise at the output. Noise is generally specified referred to input (RTI), but it is often simpler to calculate the noise referred to the output (RTO) and then divide by the noise gain to obtain the RTI noise.

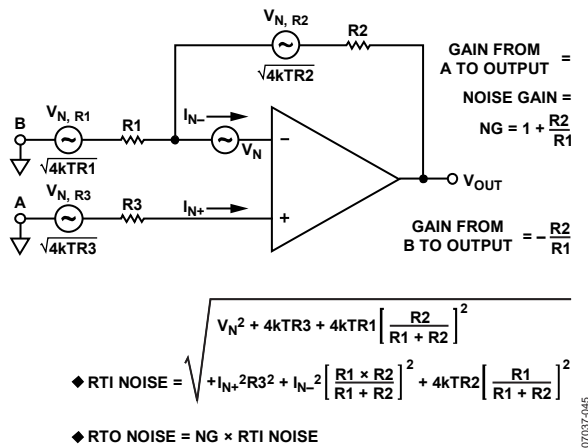

Figure 48. Op Amp Noise Analysis Model

All resistors have a Johnson noise that is calculated by

$$\sqrt{(4kBT R)}$$

where:

k is Boltzmann's constant (1.38×10^{-23} J/K).

B is the bandwidth in Hertz.

T is the absolute temperature in Kelvin.

R is the resistance in ohms.

A simple relationship that is easy to remember is that a 50 Ω resistor generates a Johnson noise of 1 nV/ $\sqrt{\text{Hz}}$ at 25°C.

In applications where noise sensitivity is critical, care must be taken not to introduce other significant noise sources to the amplifier. Each resistor is a noise source. Attention to the following areas is critical to maintain low noise performance: design, layout, and component selection. A summary of noise performance for the amplifier and associated resistors is shown in Table 7.

CIRCUIT CONSIDERATIONS

Careful and deliberate attention to detail when laying out the ADA4898-1 board yields optimal performance. Power supply bypassing, parasitic capacitance, and component selection all contribute to the overall performance of the amplifier.

PCB LAYOUT

Because the ADA4898-1 bandwidth extends up to 65 MHz, it is essential that RF board layout techniques be employed. All ground and power planes under the pins of the ADA4898-1 should be cleared of copper to prevent the formation of parasitic capacitance between the input pins to ground and the output pins to ground. A single mounting pad on a SOIC footprint can add as much as 0.2 pF of capacitance to ground if the ground plane is not cleared from under the mounting pads.

POWER SUPPLY BYPASSING

Power supply bypassing for the ADA4898-1 has been optimized for frequency response and distortion performance. Figure 46 shows the recommended values and location of the bypass capacitors. Power supply bypassing is critical for stability, frequency response, distortion, and PSR performance. The 0.1 μF capacitors shown in Figure 46 should be as close to the supply pins of the ADA4898-1 as possible. The 10 μF electrolytic capacitors should be adjacent to but not necessarily close to the 0.1 μF capacitors. The capacitor between the two supplies helps improve PSR and distortion performance. In some cases, additional paralleled capacitors can help improve frequency and transient response.

GROUNDING

Ground and power planes should be used where possible. Ground and power planes reduce the resistance and inductance of the power planes and ground returns. The returns for the input and output terminations, bypass capacitors, and R_G should all be kept as close to the ADA4898-1 as possible. The output load ground and the bypass capacitor grounds should be returned to the same point on the ground plane to minimize parasitic trace inductance, ringing, and overshoot and to improve distortion performance.

The ADA4898-1 package features an exposed paddle. For optimum electrical and thermal performance, solder this paddle to negative supply plane. For more information on high speed circuit design, see *A Practical Guide to High-Speed Printed-Circuit-Board Layout*, Analog Dialogue: PCB Layout at www.analog.com.

ADA4898-1

OUTLINE DIMENSIONS

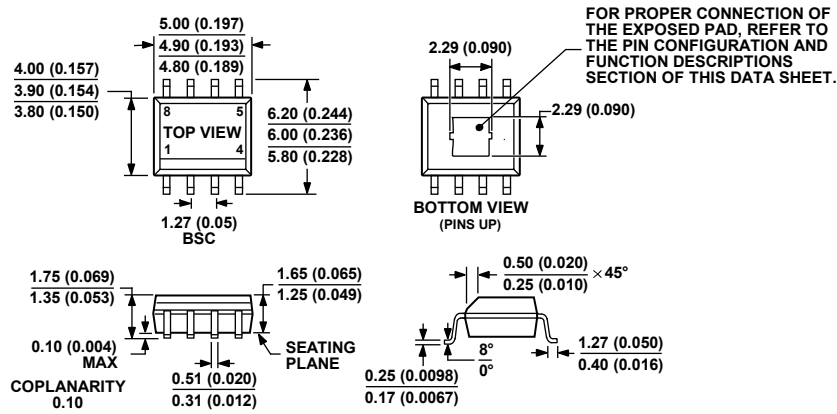

COMPLIANT TO JEDEC STANDARDS MS-012-AA
 CONTROLLING DIMENSIONS ARE IN MILLIMETER; INCH DIMENSIONS (IN PARENTHESES) ARE ROUNDED-OFF MILLIMETER EQUIVALENTS FOR REFERENCE ONLY AND ARE NOT APPROPRIATE FOR USE IN DESIGN.
 Figure 49. 8-Lead Standard Small Outline Package with Exposed Pad [SOIC_N_EP] (RD-8-1)
 Dimensions shown in millimeters and (inches)

072809A

ORDERING GUIDE

Model	Temperature Range	Package Description	Package Option	Ordering Quantity
ADA4898-1YRDZ ¹	-40°C to +105°C	8-Lead SOIC_N_EP	RD-8-1	1
ADA4898-1YRDZ-R7 ¹	-40°C to +105°C	8-Lead SOIC_N_EP	RD-8-1	1,000
ADA4898-1YRDZ-RL ¹	-40°C to +105°C	8-Lead SOIC_N_EP	RD-8-1	2,500

¹ Z = RoHS Compliant Part.

NOTES

ADA4898-1

NOTES