

AN7086S

Recording/Playback Pre-/Power Amplifier IC for 3V Microcassette

■ Overview

The AN7086S is an integrated circuit developed for recording playback pre-/power amp., built-in VAS (Voice Activated System) function especially.

■ Features

- Rec. playback pre-/power amp. IC
- VAS function built-in
- Earphone monitor at recording is possible
- 350mW BTL, OCL power amp. built-in
- Mic. amp built-in
- ALC function built-in
- Rec./Play switching is possible with a single circuit switch

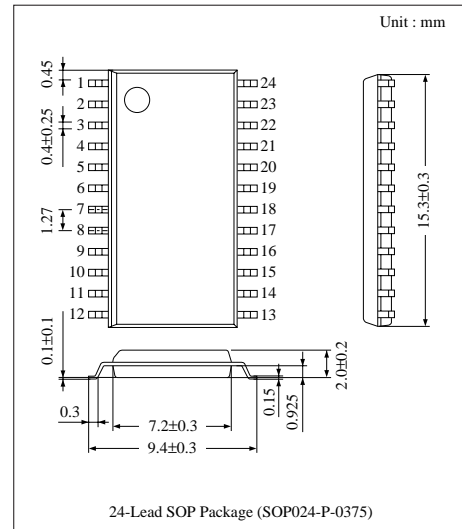

■ Block Diagram

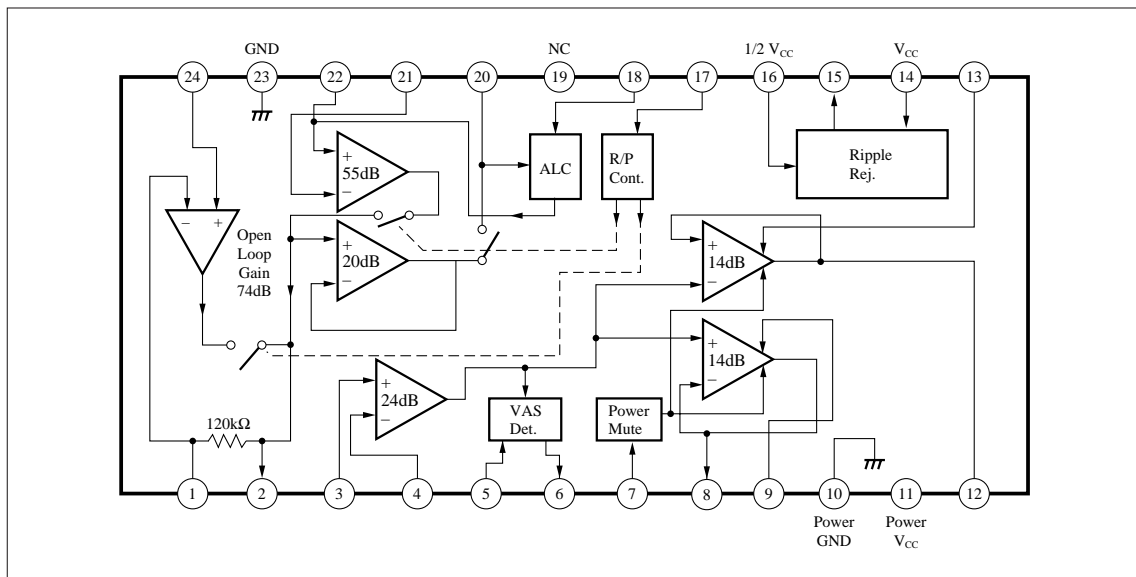

■ Absolute Maximum Ratings (Ta=25°C)

Parameter	Symbol	Rating	Unit
Supply Voltage	V _{CC}	6	V
Supply Current	I _{CC}	1000	mA
Power Dissipation	P _D	520	mW
Operating Ambient Temperature	T _{opr}	-20 ~ + 75	°C
Storage Temperature	T _{stg}	-55 ~ + 125	°C

■ Recommended Operating Range (Ta= 25°C)

Parameter	Symbol	Range
Operating Supply Voltage Range	V _{CC}	1.8V ~ 4.5V

■ Electrical Characteristics (V_{CC}=3V, f=1kHz, Ta=25°C)

Parameter	Symbol	Condition	min.	typ.	max.	Unit
Quiescent Circuit Current	I _{tot}	At No Input/Playback	10	20	35	mA

<Pre-Amp.>

Open Circuit Gain	G _{V1}	V _{in} = - 85dBV, R _g = 1kΩ	65	74	—	dB
Total Harmonic Distortion	THD _I	V _{in} = 3mVrms, R _g = 1kΩ	—	0.1	1	%
Maximum Output Voltage	V _{O1}	THD= 1%, R _g = 1kΩ	0.3	0.6	—	Vrms
Noise Voltage Referred to Input	V _{ni}	R _g = 1kΩ, DIN/AUDIO Filter	—	1	1.8	μVrms

<Recording Amp.>

Close Circuit Gain	G _{V2}	V _{in} = - 80dBV	69.5	72.5	75.5	dB
Total Harmonic Distortion	THD _R	V _{in} = - 80dBV	—	1.3	3	%
Maximum Output Voltage	V _{oR}	THD = 5%	0.8	1.08	—	Vrms
Output Noise Voltage	V _{nR}	R _g = 2.2kΩ, DIN/AUDIO Filter	—	-46	-42	dBV

<Power Amp.>

Closed Circuit Gain	G _{V - P_O}	V _{in} = 5mVrms, R _L = 8Ω	38.5	41	43.5	dB
Total Harmonic Distortion	THD - P _O	V _{in} = 5mVrms, R _L = 8Ω	—	0.11	1	%
Maximum Output Voltage	V _{O - P_O}	THD = 10%, R _L = 8Ω	300	350	—	mW
Output Noise Voltage	V _{n - P_O}	R _g = 0Ω, R _L = 8Ω, DIN/AUDIO Filter	—	-74	-65	dBV
Output Offset Voltage	V _{DC}	R _g = 0Ω, R _L = 8Ω,	-50	0	50	mV

<VAS>

VAS Operation Input Voltage	VAS	Mic. input level at Piny Voltage= 0.2V	8	14	18	μVrms
-----------------------------	-----	---	---	----	----	-------

<ALC>

Effective Voltage	V _{ALC}	V _{in} = - 60dBV, R _g = 1.5kΩ	-6.6	-4.5	-2.5	dBV
Effective width	W _{ALC}	V _{in} = - 30dBV, R _g = 1.5kΩ	—	1.5	3	%

<Ripple Rejection>

Playback System Ripple Rejection	RR _P	f _r = 270Hz, V _r = 30mVrms, R _g = 1kΩ	—	-70	-50	dBV
Recording System Ripple Rejection	RR _R	f _r = 270Hz, V _r = 30mVrms, R _g = 2.2kΩ	—	-40	-30	dBV

<Switching Pin>

Rec./Playback Switching Pin	V _{PB}	Playback mode	0.1	—	0.3	V
Rec./Playback Switching Pin	V _{REC}	Recording mode	1.6	—	2.3	V

■ Characteristics Curve

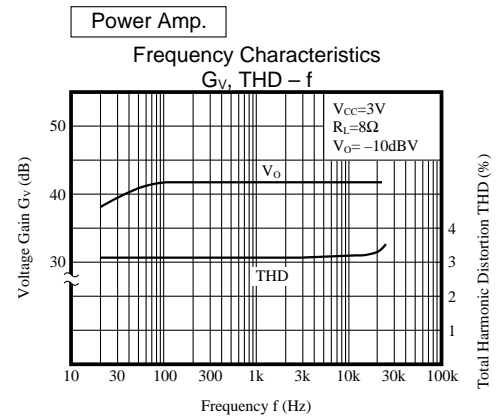
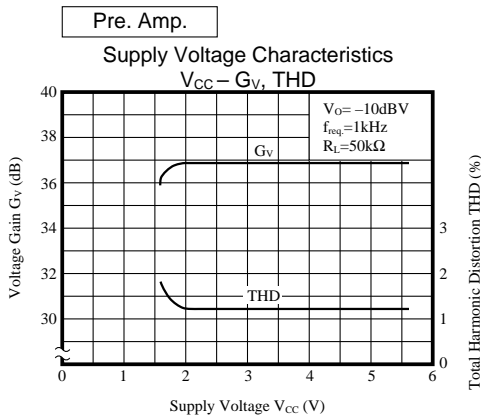
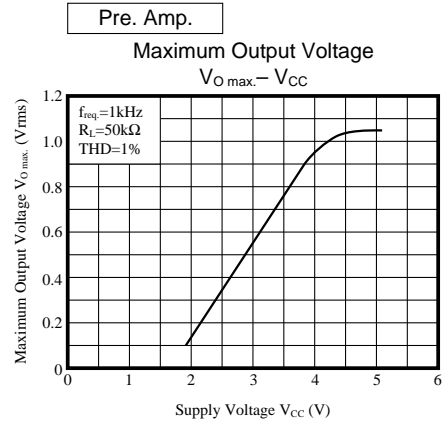
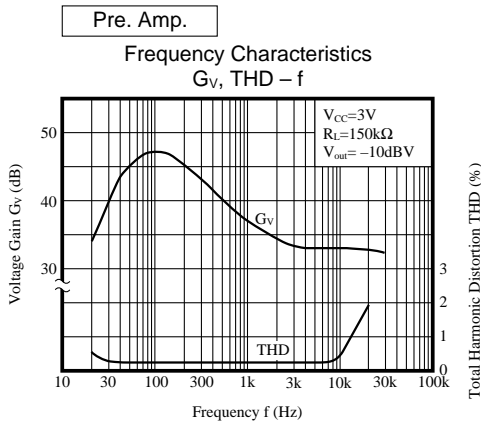
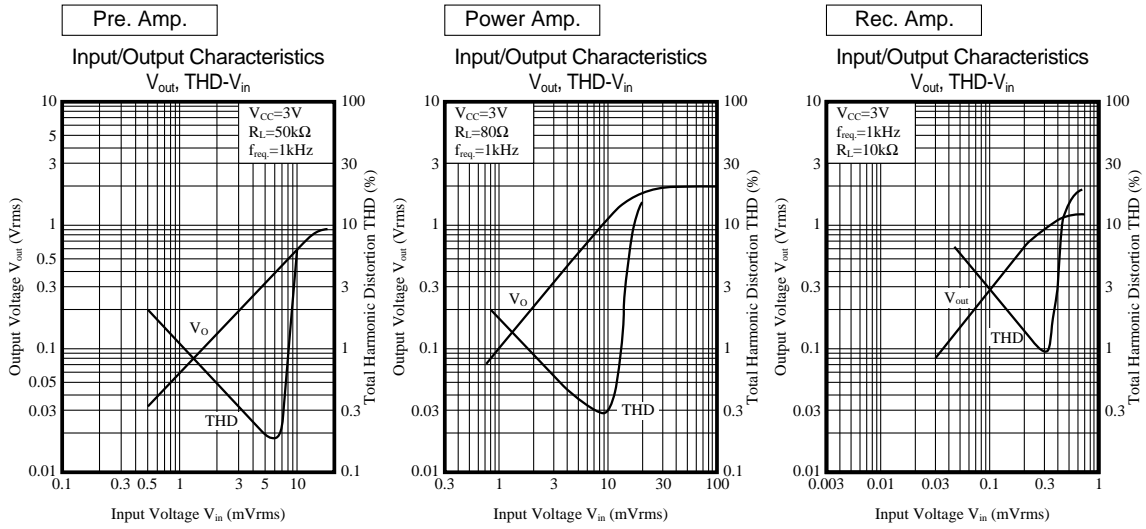

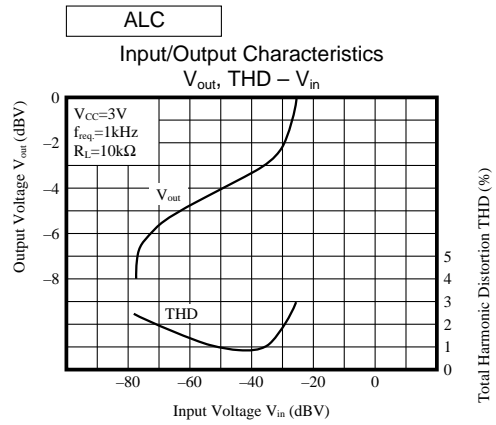
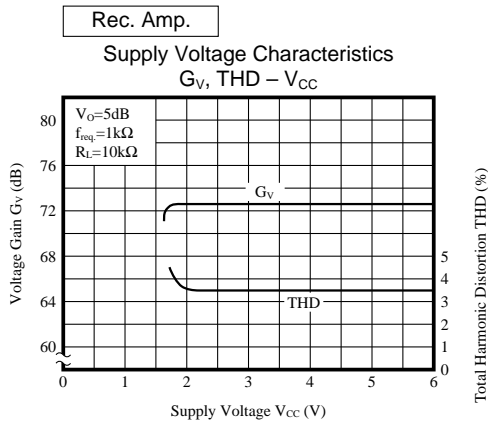
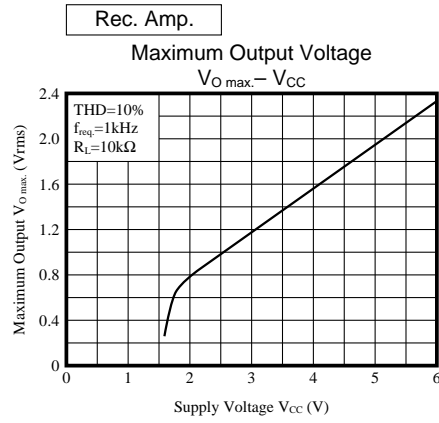
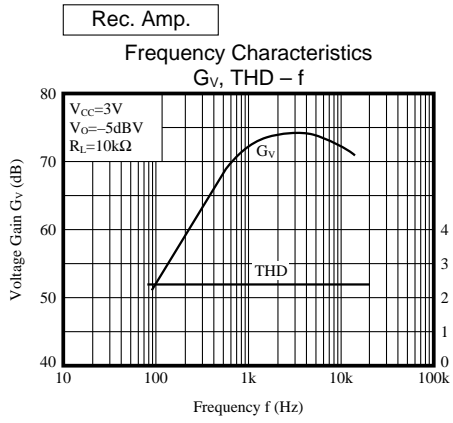
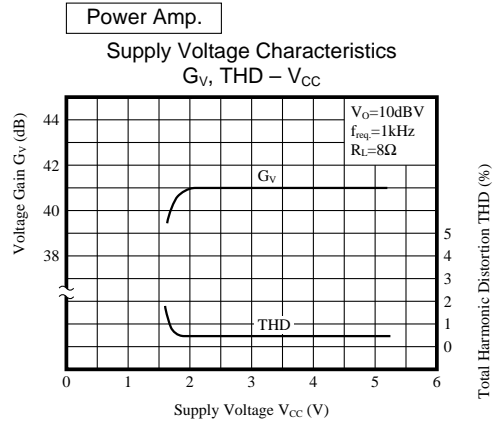
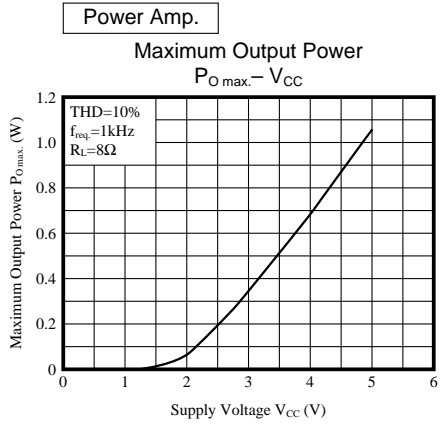

■ Application Circuit

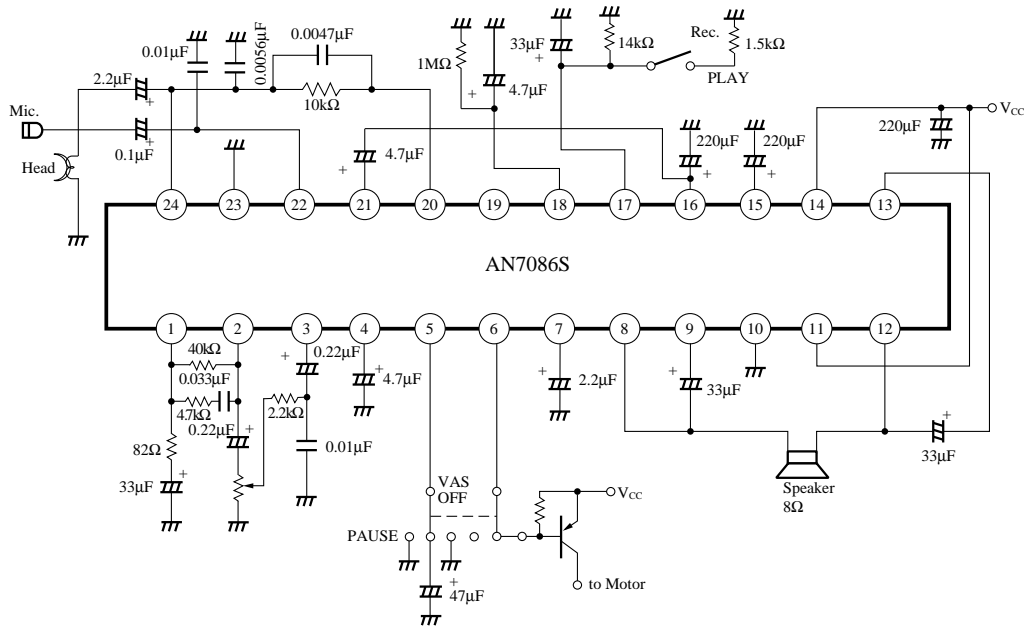

■ Pin Descriptions

Pin No.	Pin Name	Pin No.	Pin Name
1	Pre-Amp. NF Pin	13	B.S.2
2	Pre-Amp. Output Pin	14	V _{CC}
3	Power Amp. Input Pin	15	Filter Pin
4	Power Amp. NF Pin	16	Center
5	VAS Detection	17	Rec./Play Switching Pin
6	MOTOR Output Pin	18	ALC Detection
7	Power Mute Pin	19	NC
8	Power Output 1 Pin	20	Rec. Amp. Output Pin
9	B.S.1	21	Mic. Amp. NF Pin
10	Power GND	22	Mic. Amp. Input Pin
11	Power V _{CC}	23	Pre. GND
12	Power Output 2-pin	24	Pre. Amp. Input Pin