

AN7512SH

Dual 1-W BTL audio power amplifier

Overview

The AN7512SH is an audio power amplifier IC with surface mount package for stereo system. The BTL (Balanced Transformer-Less) method can provide fewer external parts and more easy design for applications.

Features

- 1-W output (8 Ω) with supply voltage of 5 V
- On-chip standby function
- On-chip volume function
- Small and thin surface mount package

Applications

- LCD televisions, monitor with speaker for personal computers

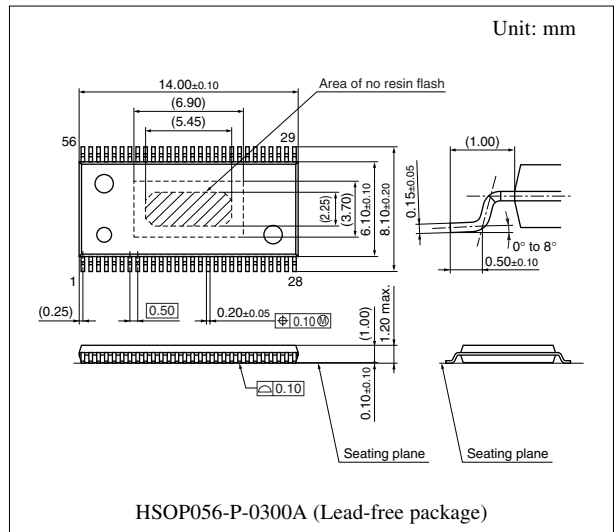

Block Diagram

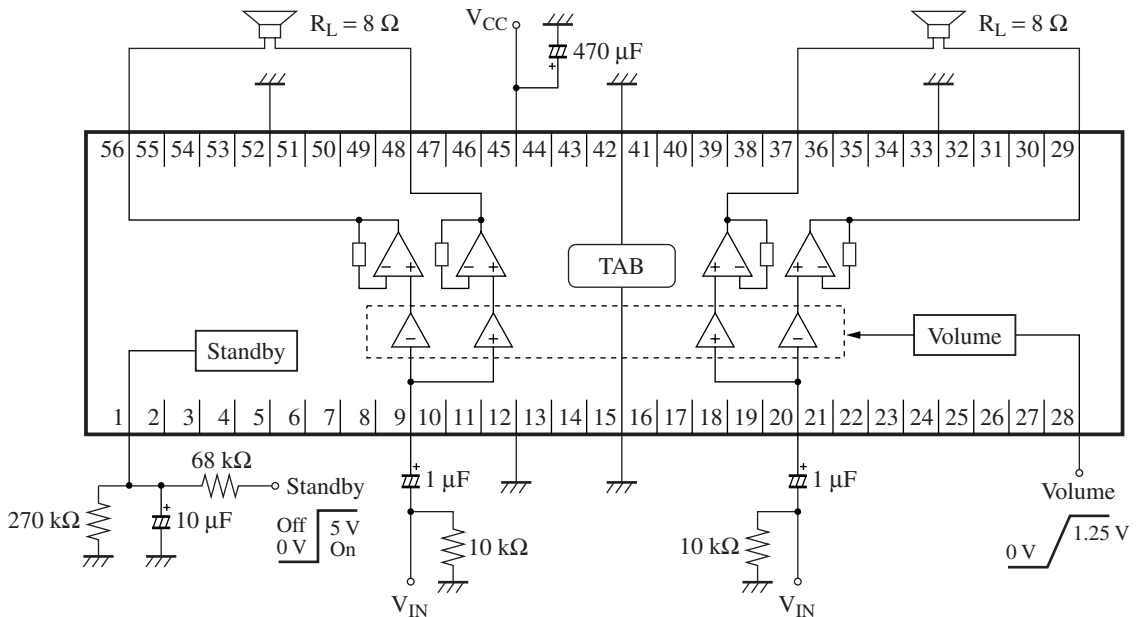

■ Pin Descriptions

Pin No.	Description	Pin No.	Description
1	Standby (standby state if this pin is open.)	33	Ground (output ch.2)
9	Ch.1 input	37	Ch.2 + output
12	Ground (input)	42	TAB (tablet)
15	TAB (tablet)	45	Supply voltage
20	Ch.2 input	48	Ch.1 + output
28	Volume (muting off if this pin is open.)	52	Ground (output ch.1)
29	Ch.2 – output	56	Ch.1 – output

N.C. Pin No.	2, 3, 4, 5, 6, 7, 8, 10, 11, 13, 14, 16, 17, 18, 19, 21, 22, 23, 24, 25, 26, 27, 30, 31, 32, 34, 35, 36, 38, 39, 40, 41, 43, 44, 46, 47, 49, 50, 51, 53, 54, 55
--------------	---

Note) Please do not apply voltage or current to the N.C. pin from outside.

■ Absolute Maximum Ratings

Parameter	Symbol	Rating	Unit
Supply voltage ^{*2}	V_{CC}	14	V
Supply current	I_{CC}	2.0	A
Power dissipation ^{*3}	P_D	690	mW
Operating ambient temperature ^{*1}	T_{opr}	-25 to +75	°C
Storage temperature ^{*1}	T_{stg}	-55 to +150	°C

Note) *1: Except for the operating ambient temperature and storage temperature, all ratings are for $T_a = 25^\circ\text{C}$.

*2: At no signal.

*3: The power dissipation shown is the value for the independent IC without a heat sink at $T_a = 25^\circ\text{C}$.

Refer to $P_D - T_a$ curves at mounted on standard board.

■ Recommended Operating Range

Parameter	Symbol	Range	Unit
Supply voltage	V_{CC}	3 to 8	V

■ Electrical Characteristics at $V_{CC} = 5.0\text{ V}$, $R_L = 8\ \Omega$, $f = 1\text{ kHz}$, $T_a = 25^\circ\text{C} \pm 2^\circ\text{C}$

Parameter	Symbol	Conditions	Min	Typ	Max	Unit
Quiescent circuit current	I_{CQ}	$V_{IN} = 0\text{ mV}$, Vol. = 0 V	—	35	100	mA
Standby current	I_{STB}	$V_{IN} = 0\text{ mV}$, Vol. = 0 V	—	1	10	μA
Output noise voltage *	V_{NO}	$R_g = 10\text{ k}\Omega$, Vol. = 0 V	—	0.10	0.4	mV[rms]
Voltage gain	G_V	$P_O = 0.25\text{ W}$, Vol. = 1.25 V	31	33	35	dB
Total harmonics distortion	THD	$P_O = 0.25\text{ W}$, Vol. = 1.25 V	—	0.10	0.5	%
Maximum output power	P_{O1}	THD = 10%, Vol. = 1.25 V	0.7	1.0	—	W
Ripple rejection ratio *	RR	$R_g = 10\text{ k}\Omega$, Vol. = 0 V, $V_R = 0.5\text{ V[rms]}$, $f_R = 120\text{ Hz}$	30	50	—	dB
Output offset voltage	V_{OFF}	$R_g = 10\text{ k}\Omega$, Vol. = 0 V	-250	0	250	mV
Volume attenuation rate *	Att	$P_O = 0.25\text{ W}$, Vol. = 0 V	70	85	—	dB
Channel balance 1	CB1	$P_O = 0.25\text{ W}$, Vol. = 1.25 V	-1	0	1	dB
Channel balance 2	CB2	$P_O = 0.25\text{ W}$, Vol. = 0.6 V	-3	0	3	dB
Intermediate voltage gain	G_{VM}	$P_O = 0.25\text{ W}$, Vol. = 0.6 V	20.5	23.5	26.5	dB
Channel crosstalk	CT	$P_O = 0.25\text{ W}$, Vol. = 1.25 V	40	55	—	dB

Note) *: In measuring, the filter for the range of 15 Hz to 30 kHz (12 dB/OCT) is used.

■ Terminal Equivalent Circuits

Pin No.	Pin name	Equivalent circuit	Voltage
1	Standby pin		Standby off at 5 V application.
2	N.C.	—	—
3	N.C.	—	—
4	N.C.	—	—
5	N.C.	—	—
6	N.C.	—	—
7	N.C.	—	—
8	N.C.	—	—

■ Terminal Equivalent Circuits (continued)

Pin No.	Pin name	Equivalent circuit	Voltage
9	Ch.1 input pin		1.4 V (Input circuit bias voltage is output.)
10	N.C.	—	—
11	N.C.	—	—
12	GND		0 V
13	N.C.	—	—
14	N.C.	—	—
15	GND	Connected to TAB	—
16	N.C.	—	—
17	N.C.	—	—
18	N.C.	—	—
19	N.C.	—	—
20	Ch.2 input pin		1.4 V (Input circuit bias voltage is output.)

■ Terminal Equivalent Circuits (continued)

Pin No.	Pin name	Equivalent circuit	Voltage
21	N.C.	—	—
22	N.C.	—	—
23	N.C.	—	—
24	N.C.	—	—
25	N.C.	—	—
26	N.C.	—	—
27	N.C.	—	—
28	Volume pin		Supplied with 0 V to 1.25 V
29	Ch.2 – output pin		2.15 V (at no signal)
30	N.C.	—	—
31	N.C.	—	—
32	N.C.	—	—
33	GND		0 V
34	N.C.	—	—
35	N.C.	—	—
36	N.C.	—	—

■ Terminal Equivalent Circuits (continued)

Pin No.	Pin name	Equivalent circuit	Voltage
37	Ch.2 + output pin		2.15 V (at no signal)
38	N.C.	—	—
39	N.C.	—	—
40	N.C.	—	—
41	N.C.	—	—
42	GND	Connected to TAB	0 V
43	N.C.	—	—
44	N.C.	—	—
45	V _{CC}	—	5.0 V
46	N.C.	—	—
47	N.C.	—	—
48	Ch.1 + output pin		2.15 V (at no signal)
49	N.C.	—	—
50	N.C.	—	—
51	N.C.	—	—

■ Terminal Equivalent Circuits (continued)

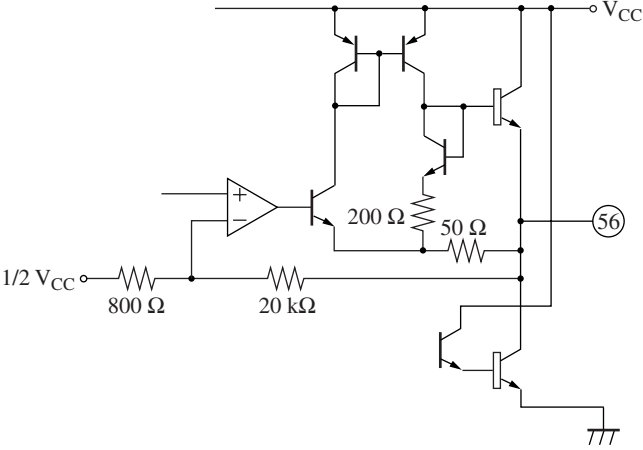
Pin No.	Pin name	Equivalent circuit	Voltage
52	GND		0 V
53	N.C.	—	—
54	N.C.	—	—
55	N.C.	—	—
56	Ch.1 – output pin		2.15 V (at no signal)

■ Usage Notes

- Please avoid the short circuit to V_{CC} , ground, or load short circuit.
- Please connect the cooling fin with the GND potential.
- The thermal shutdown circuit operates at about $T_j = 150^{\circ}\text{C}$. However, the thermal shutdown circuit is reset automatically if the temperature drops.
- Please carefully design the heat radiation especially when you take out high power at high V_{CC} .
- Please connect only the ground for the signal input with the signal GND of the amplifier in the previous stage.
- Take notice that the ripple rejection ratio is poor in case of headphone use.
- Take notice that as to following pins, electric surge voltage is low.
At 200 pF, Pin1 = +140 V, Pin9 = +140 V, Pin20 = +130 V, Pin28 = +150 V.
- Use a speaker with 8 Ω or more impedance.

■ Technical Data

• $P_D - T_a$ curve of HSOP056-P-0300A

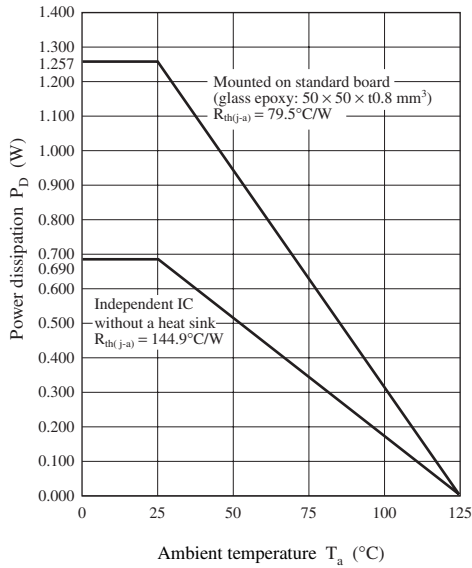

• Main characteristics

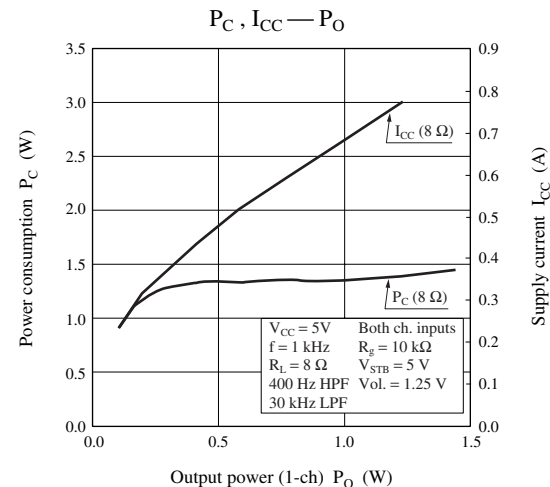
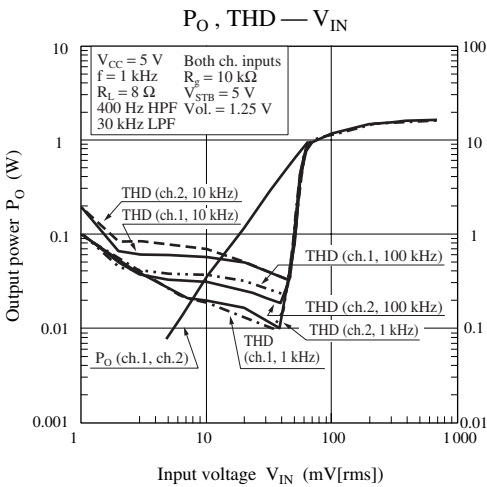
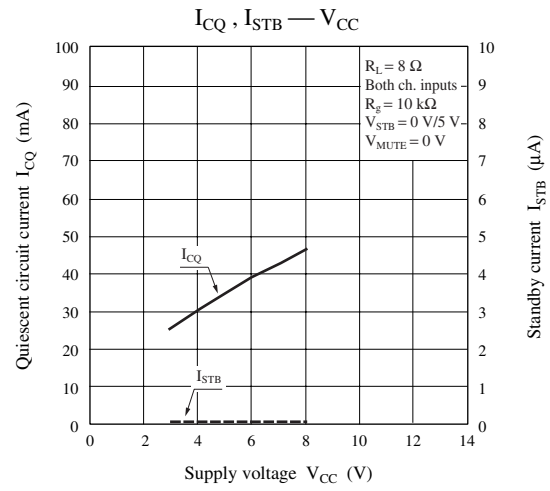
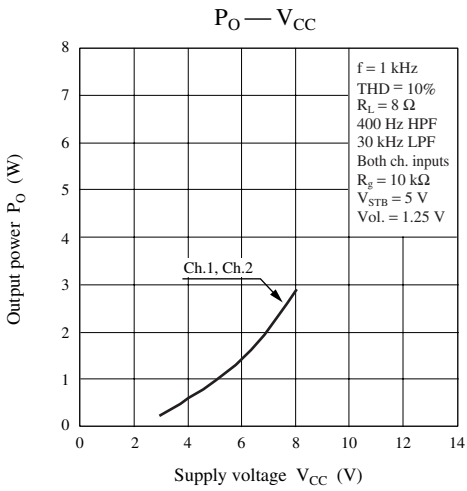
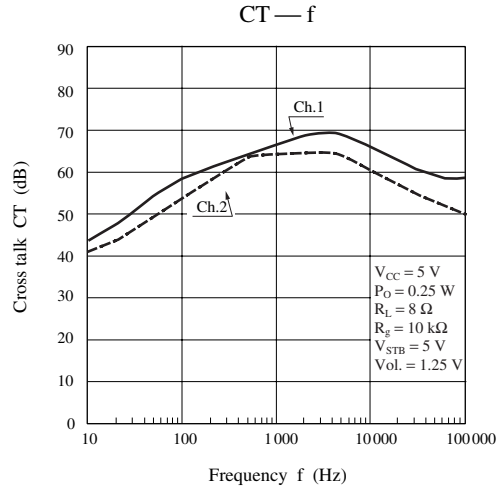

■ Technical Data (continued)

• Main characteristics (continued)

$G_V, P_O - f$

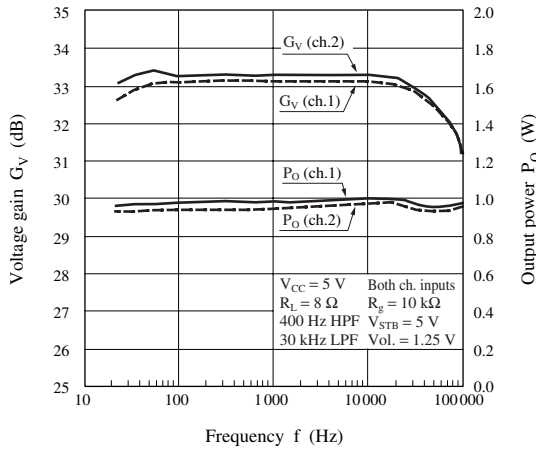

THD — f

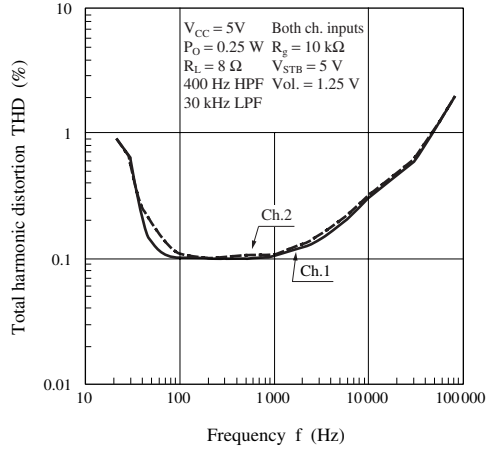

$G_V, THD - V_{CC}$

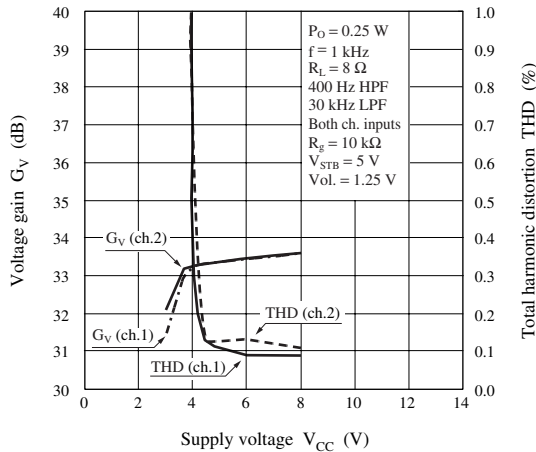

Att — Vol.

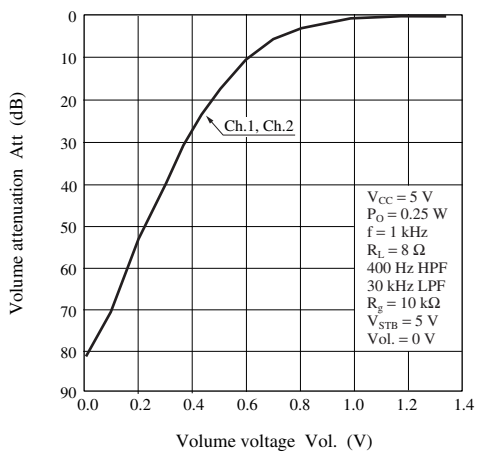

RR — V_{RIPPLE}

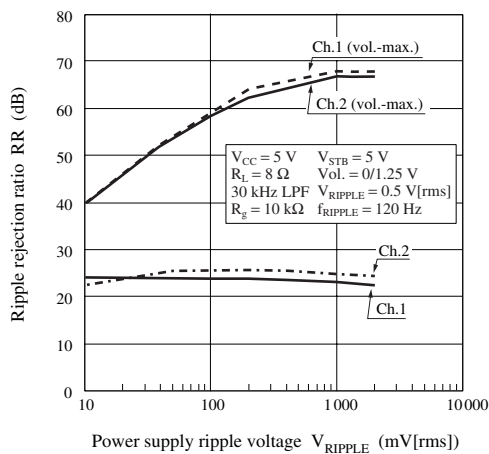

RR — f_{RIPPLE}

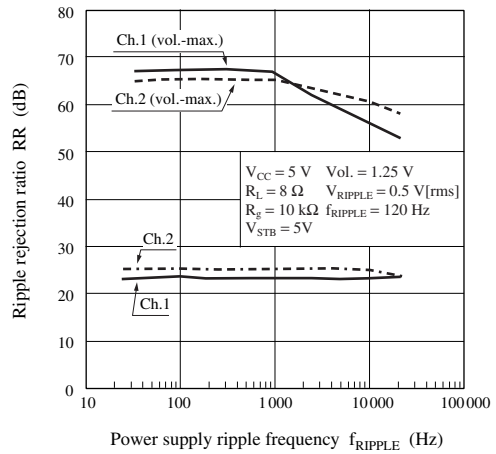

■ Technical Data (continued)

• Main characteristics (continued)

RR — V_{CC}

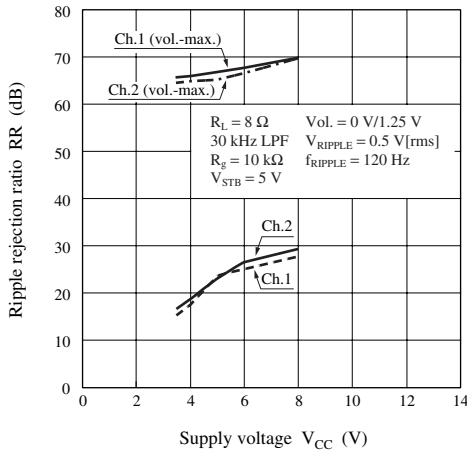

RR — Vol.

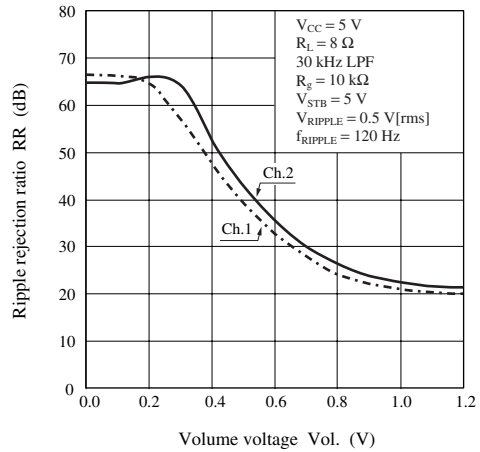

V_{NO} — V_{CC}

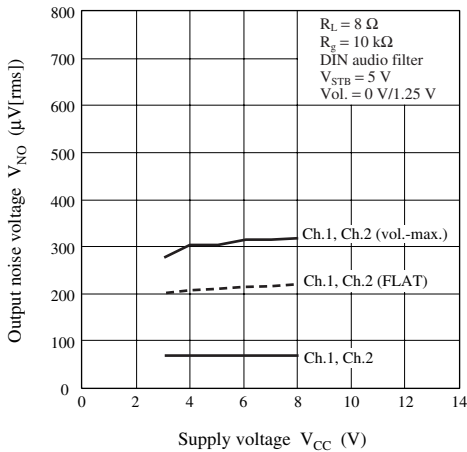

V_{NO} — R_g

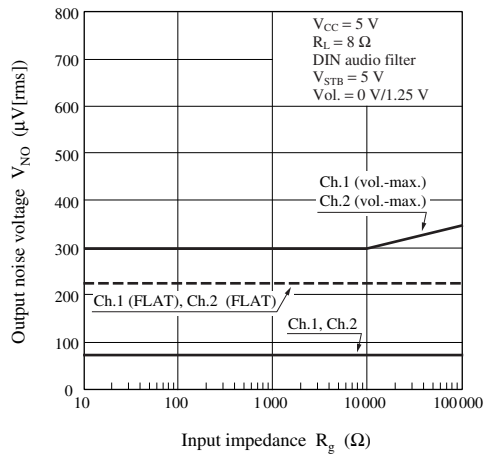

V_{NO} — Vol.

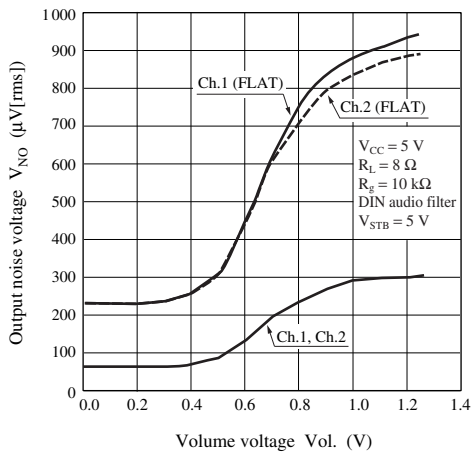

I_{CQ} — V_{STB}

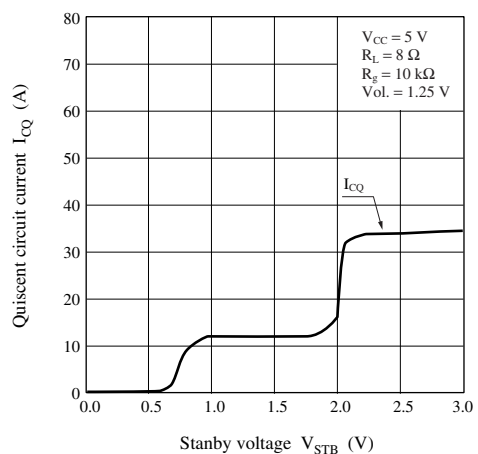

■ Technical Data (continued)

• Main characteristics (continued)

Att — V_{CC}

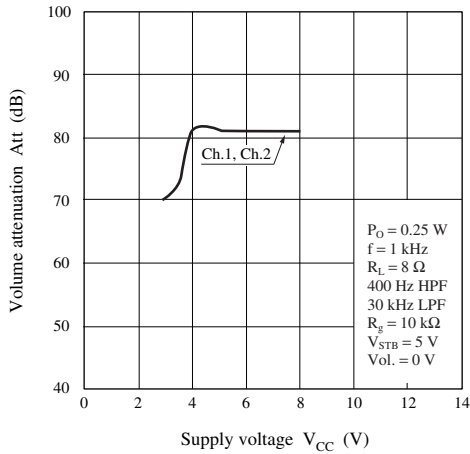

Att — V_{IN}

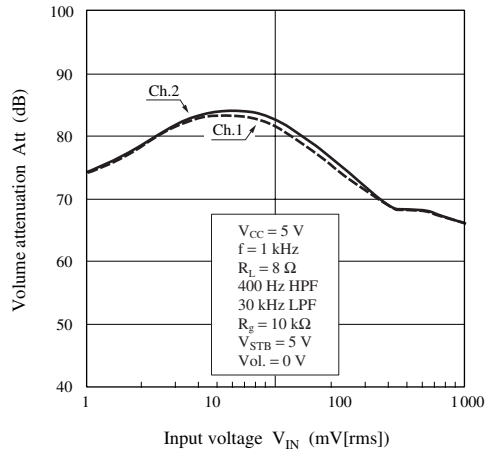

Att — f

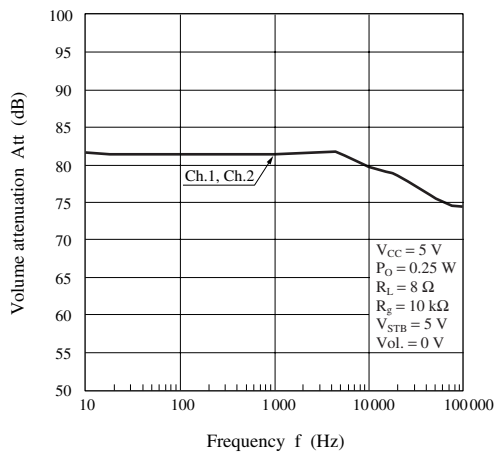

THD — Vol.

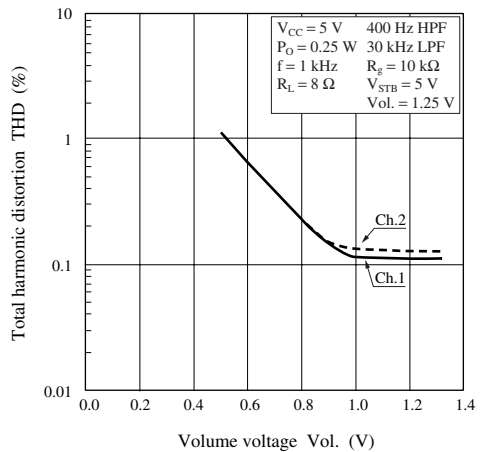

CT — V_{CC}

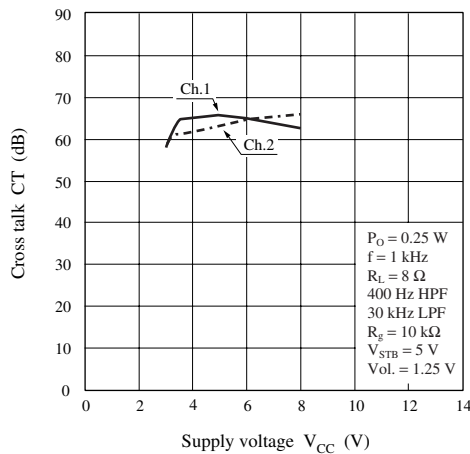

CT — V_{IN}

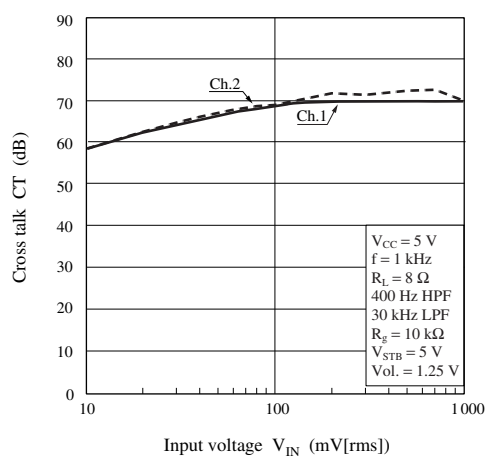

Request for your special attention and precautions in using the technical information and semiconductors described in this material

- (1) An export permit needs to be obtained from the competent authorities of the Japanese Government if any of the products or technologies described in this material and controlled under the "Foreign Exchange and Foreign Trade Law" is to be exported or taken out of Japan.
- (2) The technical information described in this material is limited to showing representative characteristics and applied circuit examples of the products. It does not constitute the warranting of industrial property, the granting of relative rights, or the granting of any license.
- (3) The products described in this material are intended to be used for standard applications or general electronic equipment (such as office equipment, communications equipment, measuring instruments and household appliances).
Consult our sales staff in advance for information on the following applications:
 - Special applications (such as for airplanes, aerospace, automobiles, traffic control equipment, combustion equipment, life support systems and safety devices) in which exceptional quality and reliability are required, or if the failure or malfunction of the products may directly jeopardize life or harm the human body.
 - Any applications other than the standard applications intended.
- (4) The products and product specifications described in this material are subject to change without notice for reasons of modification and/or improvement. At the final stage of your design, purchasing, or use of the products, therefore, ask for the most up-to-date Product Standards in advance to make sure that the latest specifications satisfy your requirements.
- (5) When designing your equipment, comply with the guaranteed values, in particular those of maximum rating, the range of operating power supply voltage and heat radiation characteristics. Otherwise, we will not be liable for any defect which may arise later in your equipment.
Even when the products are used within the guaranteed values, redundant design is recommended, so that such equipment may not violate relevant laws or regulations because of the function of our products.
- (6) When using products for which dry packing is required, observe the conditions (including shelf life and after-unpacking standby time) agreed upon when specification sheets are individually exchanged.
- (7) No part of this material may be reprinted or reproduced by any means without written permission from our company.

Please read the following notes before using the datasheets

- A. These materials are intended as a reference to assist customers with the selection of Panasonic semiconductor products best suited to their applications.
Due to modification or other reasons, any information contained in this material, such as available product types, technical data, and so on, is subject to change without notice.
Customers are advised to contact our semiconductor sales office and obtain the latest information before starting precise technical research and/or purchasing activities.
- B. Panasonic is endeavoring to continually improve the quality and reliability of these materials but there is always the possibility that further rectifications will be required in the future. Therefore, Panasonic will not assume any liability for any damages arising from any errors etc. that may appear in this material.
- C. These materials are solely intended for a customer's individual use.
Therefore, without the prior written approval of Panasonic, any other use such as reproducing, selling, or distributing this material to a third party, via the Internet or in any other way, is prohibited.