

SANYO

No. 919D

LA4192

1 to 2.3W 2-Channel af Power Amp.

FEATURES

- Has two channels that can be used for either stereo or bridge amp.
- High outputs: LA4192 provides 2.3 W per channel for 2 channel stereo connected at $V_{CC} = 9\text{ V}$, $R_L = 4\Omega$, or 4.7 W bridge amp. (for $R_L = 8\Omega$).
- Voltage gain is variable by externally connected feedback resistors:
For 2-channel: $R_{NF} = 27\Omega$, $VG = 50\text{ dB}$
Bridge amp. connected: $R_{NF} = 51\Omega$, $VG = 51\text{ dB}$
- Switching distortions in higher frequencies have been held low.
- The builtin muting circuit keeps noises caused by turning power on and off at low levels.
- The builtin ripple filter provides good ripple rejection factors.
- Excels in channel separation.

Maximum Ratings/ $T_a = 25^\circ\text{C}$

				unit
Maximum supply voltage	V_{CC} max	With signals	11	V
		With no signal	15	V
Allowable power dissipation	P_d max	With P-plate (See $P_d - T_a$ diagram)	4	W
Operating temperature	T_{opr}		-20 ~ +75	$^\circ\text{C}$
Storage temperature	T_{stg}		-55 ~ +150	$^\circ\text{C}$

Recommended Operatings Ranges/ $T_a = 25^\circ\text{C}$

				unit
Supply voltage	V_{CC}		9	V
Load resistance	R_L	2-channel	4 ~ 8	Ω
		Bridge	8	Ω

Operating Characteristics/ $T_a = 25^\circ\text{C}$, $V_{CC} = 9\text{ V}$, $f = 1\text{ kHz}$, $R_g = 600\Omega$, $R_L = 4\Omega$, () denotes values for 8Ω , in the specified test circuit

			min	typ	max	unit		
Quiescent current	I_{cco}	For 2 channels	6 V	35	55	mA		
			7.5 V	40		mA		
Voltage gain	VG	Closed loop, $R_{NF} = 27\Omega$, $V_{IN} = -51\text{ dBm}$	2-channel	48	50	52	dB	
				Bridge	49	51	53	dB

Continued on next page.

Note: Basically, this package dissipates heat by using the copper foil section of the printed circuit board, but because power dissipation P_d can be increased by power voltages and load conditions, it is recommended that a heat sink be used in conjunction with the printed circuit board.

Package Dimensions 3022A
(unit: mm)

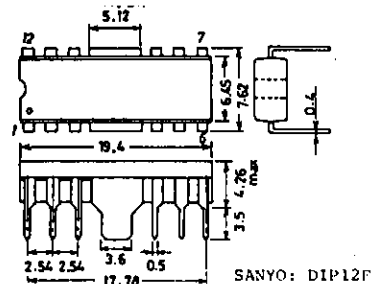

Continued from preceding page.

				min	typ	max	unit
Voltage gain imbalance	ΔVG		2-channel			2	dB
Output power	P_o	THD = 10%	2-channel	1.7	2.3		W
		THD = 10%	2-channel		(1.3)		
		THD = 10%	Bridge		(4.7)		W
Total harmonic distortion	THD	$P_o = 250$ mW	2-channel		0.5	2.0	%
Input resistance	r_i			21	30		k Ω
Output noise voltage	VNO	$R_g = 0$	2-channel		0.5	1.3	mV
		$R_g = 10$ k Ω	2-channel		0.8	2.5	mV
Ripple rejection	R_r	$R_g = 0, V_R = 150$ mV	2-channel		46		dB
Channel separation	CH sep	$R_g = 10$ k $\Omega, v_o = 0$ dBm	2-channel	40	55		dB

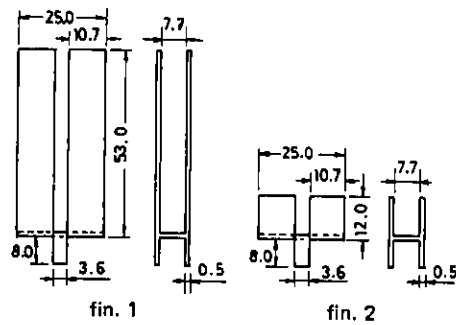
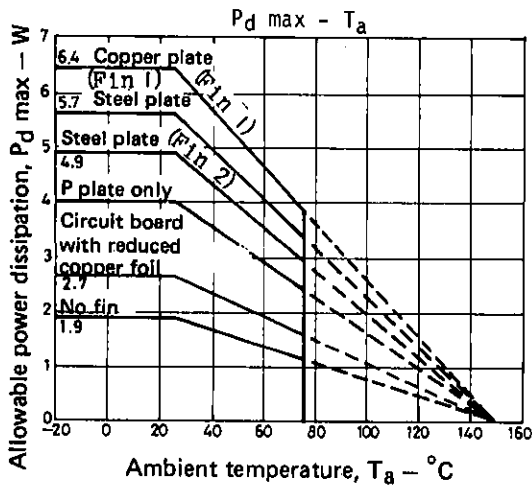

Equivalent circuit block diagram

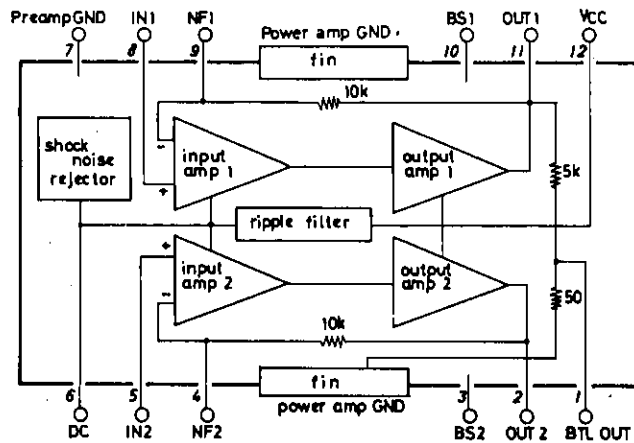

Unit (resistance: Ω)

LA4192

Sample application circuit 1: For 2-channel

Unit (resistance: Ω , capacitance: F)

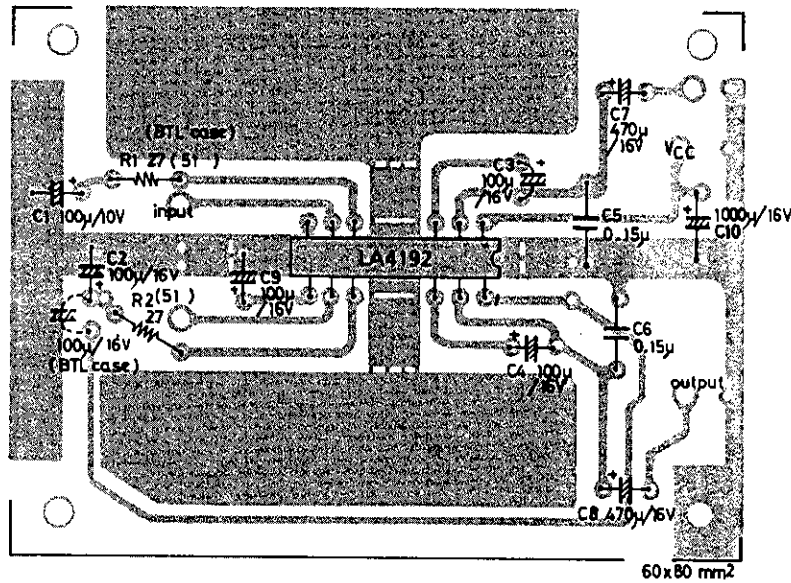
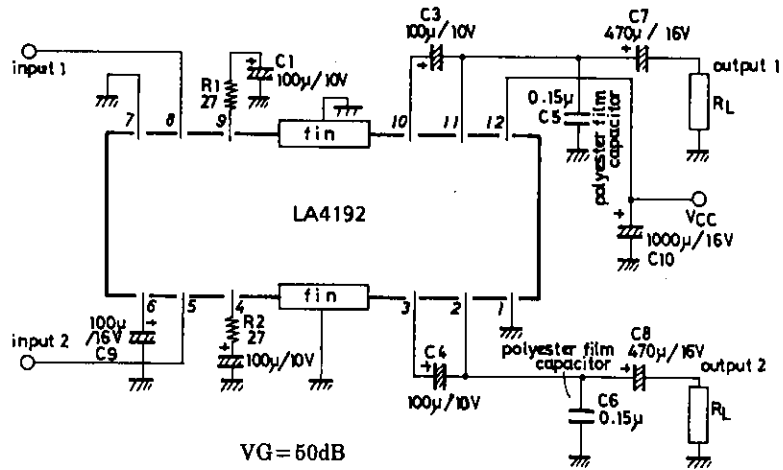

Sample printed pattern for 2 channel and bridge amp. (copper foil side)

Sample application circuit 2: Bridge amp. connected

Unit (resistance: Ω , capacitance: F)

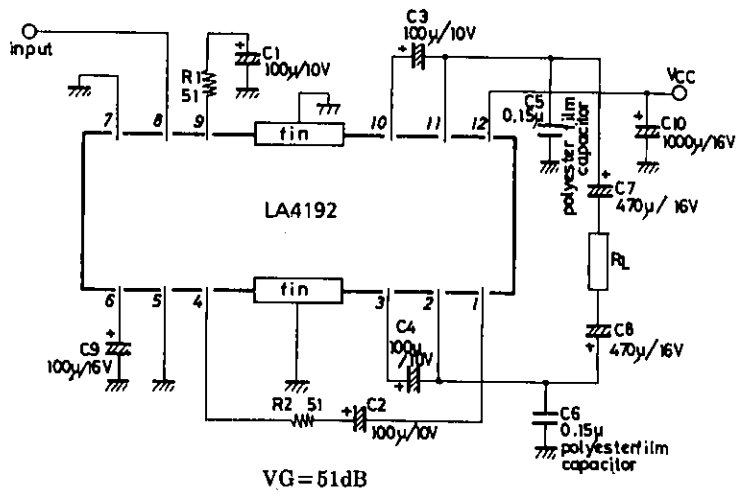

Externally connected components and comments

C1 (C2): Feedback capacitor: The lower cut-off frequency is given by the following formula:

$$f_L = \frac{1}{2\pi C1 R_f} \quad \begin{matrix} f_L: & \text{Lower cut-off frequency} \\ R_f: & \text{Feedback resistance} \end{matrix}$$

This requires careful review, because, together with decoupling capacitor, it affects the starting time.

R1 (R2): Feedback resistor: Voltage gain is determined by ratio to the builtin resistor. Use $\pm 5\%$ -tolerance resistors to enhance balance of voltage gains for the two channels.

C3 (C4): Bootstrap capacitor: Capacitance affects output in the low-frequency range; employment of small-value capacitance causes reduced outputs in lower frequencies. Employ at least 47 μF .

C5 (C6): De-oscillating capacitor: Use a mylar capacitor that excels in temperature and frequency characteristics. If an aluminum electrolytic or a ceramic capacitor is used, it may cause oscillation.

C7 (C8): Output capacitor: The lower cut-off frequency is given by the following formula:

$$f_L = \frac{1}{2\pi C7 R_L} \quad \begin{matrix} f_L: & \text{Lower cut-off frequency} \\ R_L: & \text{Load resistance} \end{matrix}$$

To obtain equivalent low-frequency characteristics for 2-channel operation with bridge amp. connected, double the capacitance.

C9: Decoupling capacitor: Though this is an arm of the ripple filter, rejection effects saturate at a certain value so that excessively large values do not serve any further purpose. It is employed for a time constant of the muting circuit, so it affects the starting time.

C10: Power supply capacitor

Concerning application circuits

1. Voltage gain adjustments

◆ 2-channel

Voltage gain is determined by resistor R1 (R2) and an externally connected feedback resistor R_f in accordance with the following formula:

$$VG = 20 \log \frac{R1 (R2)}{R_f} \text{ [dB]}$$

By suitable selection of the externally connected resistor R_f , any voltage gain can be obtained. It is preferable, however, that the voltage gain is chosen in the range of 45 dB to 50 dB. Incidentally, R1 (R2) = 10 $\text{k}\Omega$ typ.

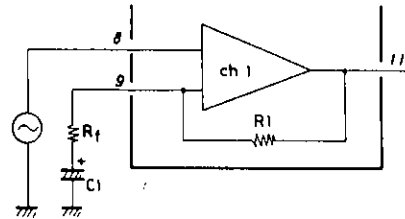

◆ Bridge Amp.

Unit (resistance: Ω)

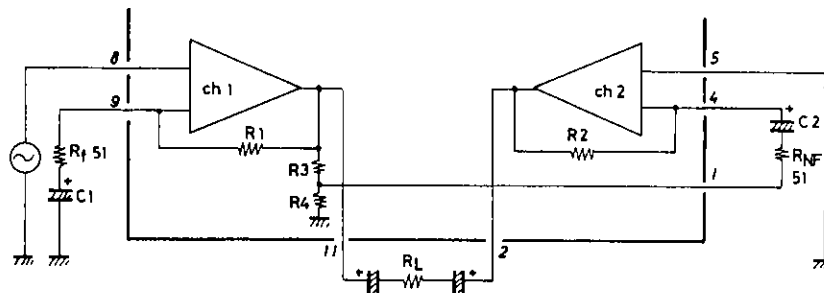

A bridge amp. connection is structured as shown above. ch-1 functions as a non-inverting amplifier and Ch-2 as an inverting amplifier. For input to ch-2, output of ch-1 is divided by resistors R3 and R4 and is led out at pin 1 as bridge amp. output. Attenuation of ch-1 output is $R3/R4$, while amplification of ch-2/ $(R_{NF} + R4)$, and due to designation for R3: 5 $\text{k}\Omega$ typ., and R4: 50 Ω typ., ch-1 output attenuation and ch-2 amplification become equal by designating $R_{NF} = 51\Omega$. When obtained at ch-2, output is the same output as ch-1 but opposite in phase. Accordingly, the overall voltage gain exhibited is 6 dB above ch-1 gain, and is approximately given by the following formula:

Continued on next page.

Continued from preceding page.

$$VG = 20 \log \frac{R_1}{R_f} + 6 \text{ [dB]}$$

If designated for $R_f = 27\Omega$, $VG = 56 \text{ dB}$ will be obtained which is excessive; it is recommended that $R_{NF} = 51\Omega$ be designated when bridge amp. is connected.

2. Crosstalk

As LA4192 is used at a voltage gain around 50 dB, feedback is shallow. It is recommended that the bridge amp. output pin (pin 1) be grounded when used for 2-channel.

3. Starting time

A builtin muting circuit suppresses shock noise when power is turned on. It utilizes time constant of C9 (decoupling capacitor), and builtin charging circuits for C1 and C2 (NF capacitors). The starting time depends on capacitances of C1 (C2) and C9 as shown below:

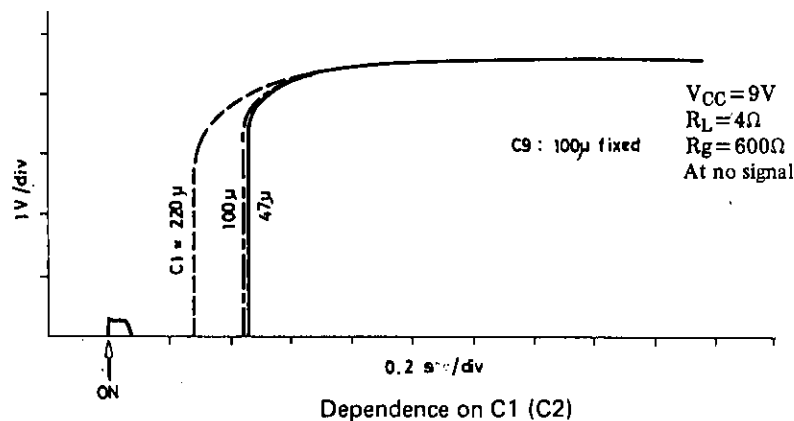
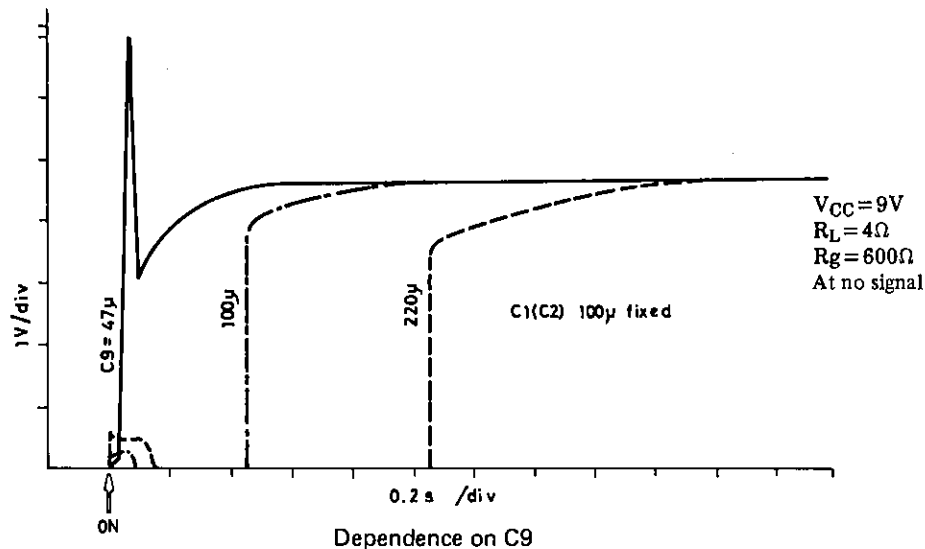

4. Cautions for use of the IC :

1. When used close to the maximum ratings, even a slight variation in conditions can cause the maximum ratings to be surpassed. This leads to breakdown failures. Be sure to provide for sufficient margins to cover variations in power voltages. Use the IC in a range that never exceeds the maximum ratings.
2. Inter-pin shortcircuits
Turning the power on with inter-pin shortcircuits causes breakage or deterioration, so that when mounting the IC on a circuit board, carefully inspect to avoid inter-pin shorts caused by soldering, before turning the power on.
3. Short-circuited loads
When used for a prolonged period with a shorted load, breakage or deterioration can result. Under no circumstance should loads be left shorted.
4. When used in a radio or radio-cassette recorder, maintain a sufficient distance between the IC and a bar antenna.
5. In making a circuit board, refer to the sample printed pattern.

■ Caution for LA4192 in sets

When LA4192 is used in a set and driven by AC mains, switching the motor on as shown below, causes instantaneous lowering of the power supply voltage, depending on the transformer regulation and other conditions.

Ripple noises are sometimes generated in the speakers or headphones. The following can be used to prevent such problems.

1. Connect a diode (a rectifier diode with an average rectified current $I_O = 100 \sim 200 \text{ mA}$) across pins 6 and 12 of LA4192, and have pin 6 potential closely follow power supply voltage variations. In a steady state, this diode will be cut off.
2. Use large enough capacitance capacitors for the power supply to suppress supply voltage variations caused when the motor is switched on.

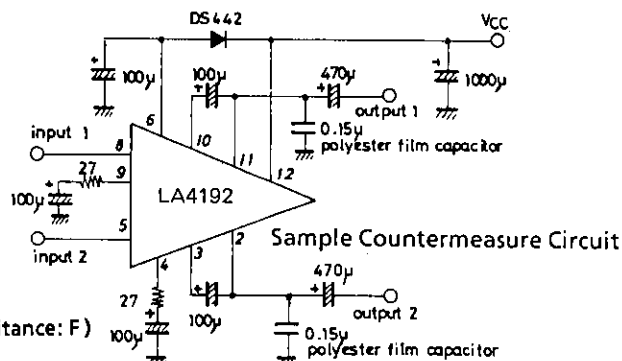

■ Heat sink design

As the package is basically heat-dissipated by utilizing a copper foil section of the printed circuit board, the area of copper foil in the vicinity of the IC heat dissipating plate should be made as broad in area as possible when designing the printed circuit board. For the sample printed pattern shown earlier, providing copper coil where indicated by the broken lines will considerably enhance heat sinking. Power consumption (P_D) can be increased depending on power supply voltage and load conditions. Use of a heat sink in conjunction with the printed circuit board is recommended. Described below are formulas to provide guide lines for P_D (for 2 channels) under various conditions of usage. For AC power supplies, it is preferable to take actual measurements at the transformer of sets. For bridge amp., simply use $\frac{1}{2}$ of employed loads in computations.

1) DC power supply

$$P_D \text{ max} = \frac{V_{CC}^2}{\pi^2 R_L} + I_{CCO} \cdot V_{CC} \text{ (for 2 channels)} \dots \dots \dots (1)$$

2) AC power supply

- V_{CC2} : Power supply voltage at no signal
- $V_{CC}(P_D)$: Power supply voltage at P_D max
- V_{CC1} : Power supply voltage at maximum output
- r : Voltage regulation $\frac{V_{CC2} - V_{CC1}}{V_{CC1}}$
- I_{CCO} : Quiescent current

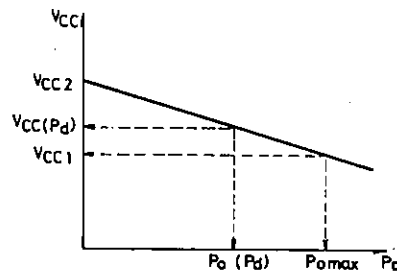

Power supply voltage variation

$$P_D \text{ max} = \frac{V_{CC}(P_D)^2}{\pi^2 R_L} + I_{CCO} \cdot V_{CC}(P_D) \text{ (for 2 channels)} \dots \dots \dots (2)$$

where

$$V_{CC}(P_D) = \frac{(1+r)V_{CC1}}{1 + \frac{r \cdot V_{CC1}}{\sqrt{2} \cdot \pi \cdot R_L} \times \sqrt{\frac{R_L}{P_{O \text{ max}}}}}$$

Sample heat sink mounting

Prepare a heat sink as shown on the next page. It is configured to be able to dissipate heat both from the IC plastic surface and its fins. Solder it on to the printed circuit board. Refer to the $P_D - T_a$ characteristics for size of heat sink. Solderable copper or steel are preferable. Silicone grease is recommended for application to the IC plastic surface to lower its thermal resistance with the heat sink.

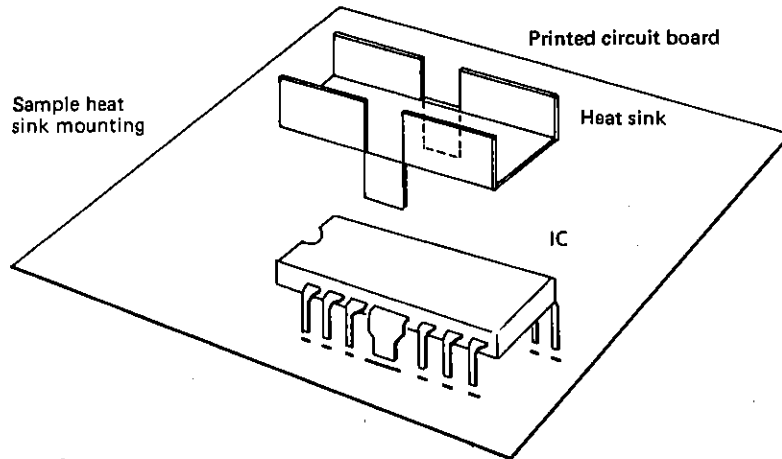

2 channel operation

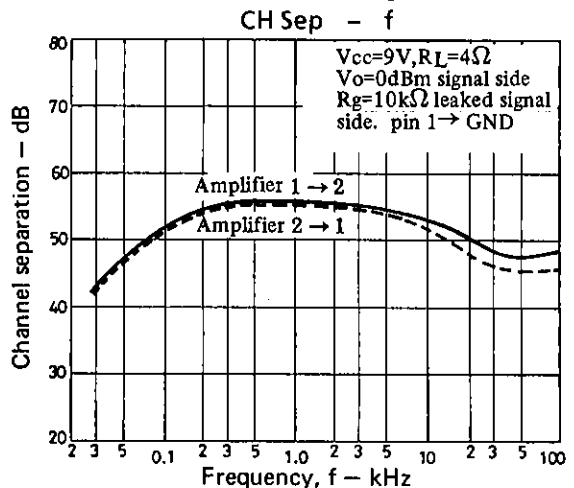
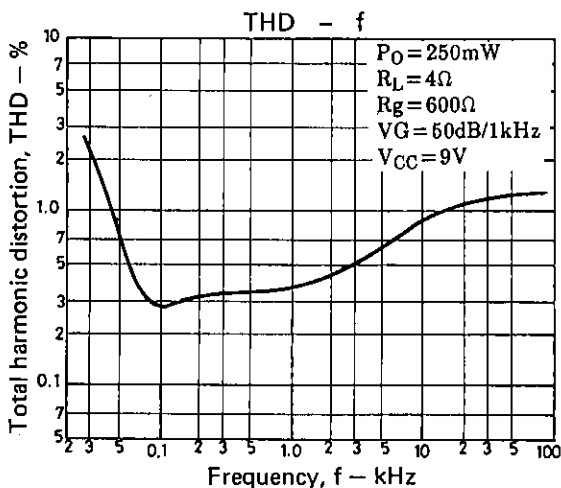
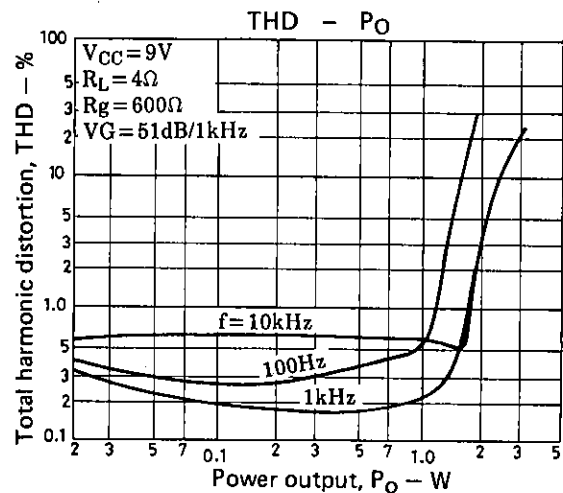
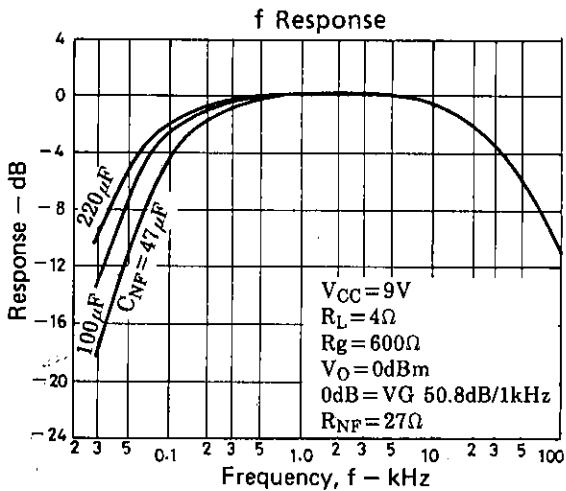
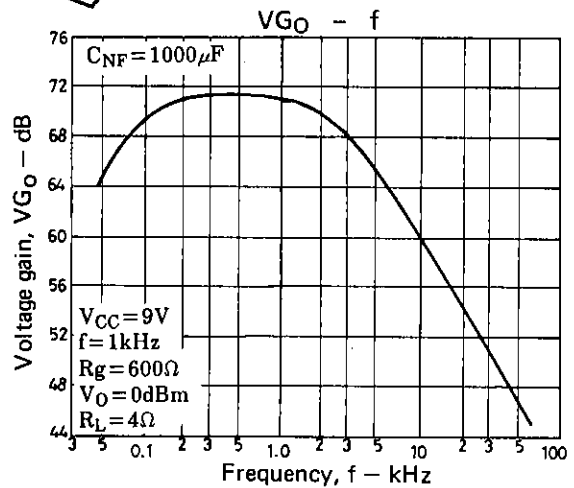
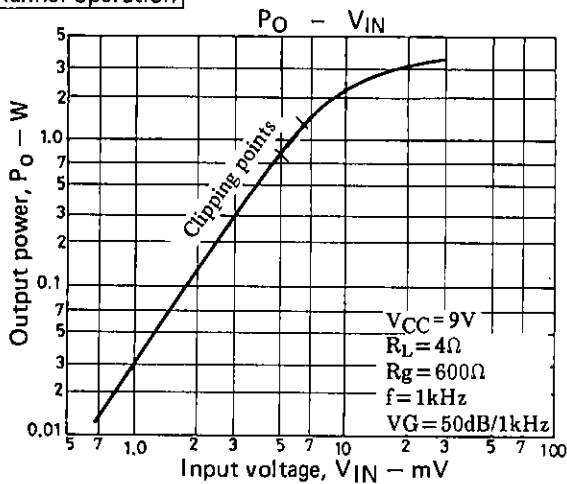

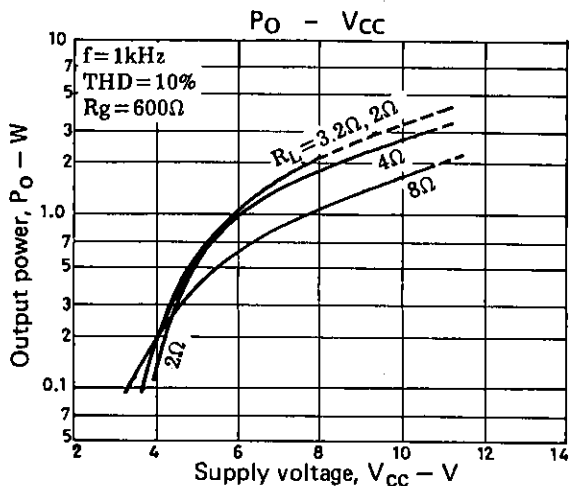
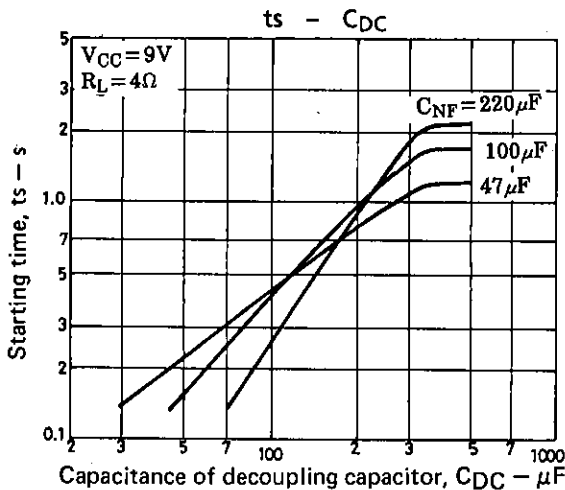
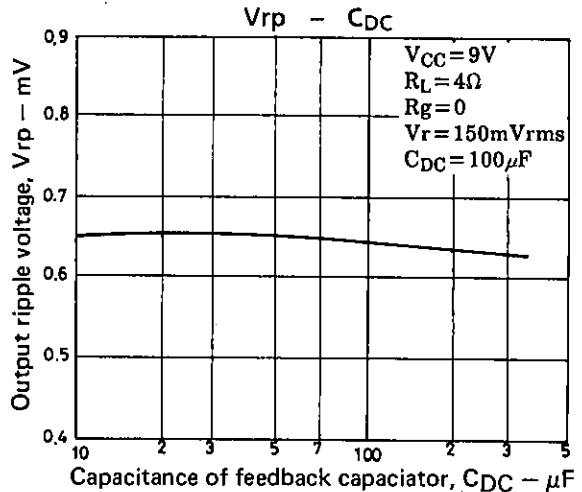
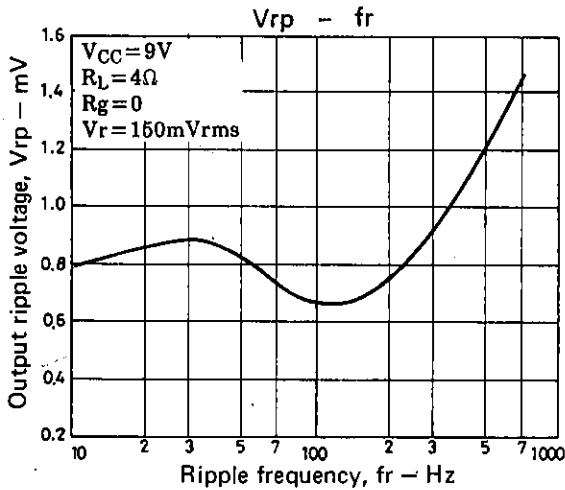
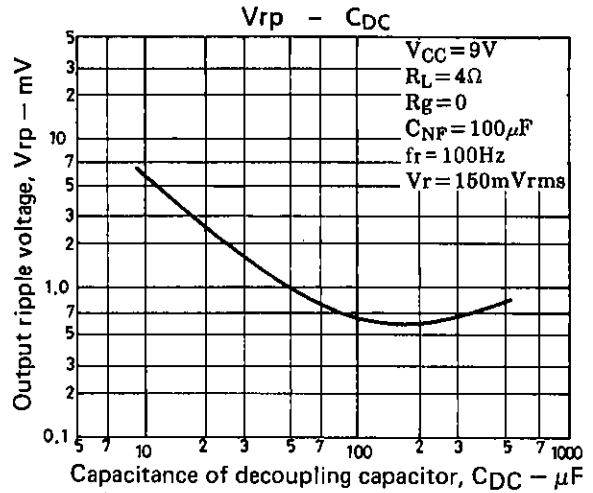
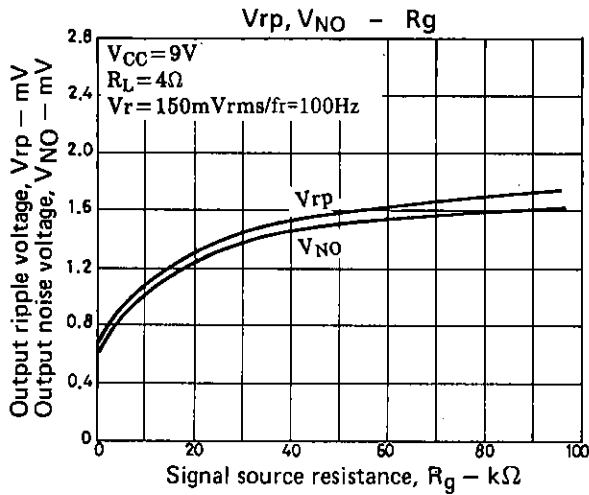
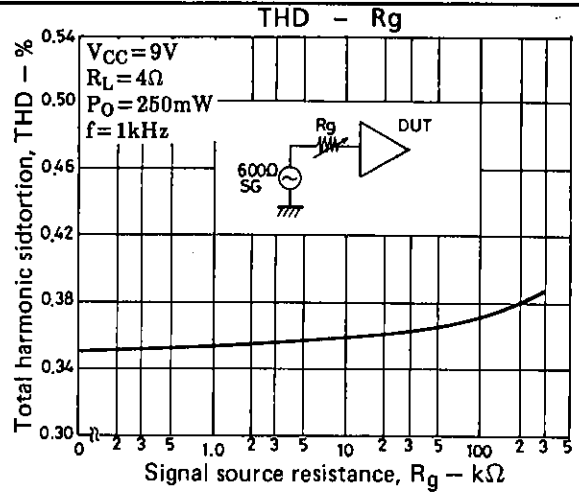
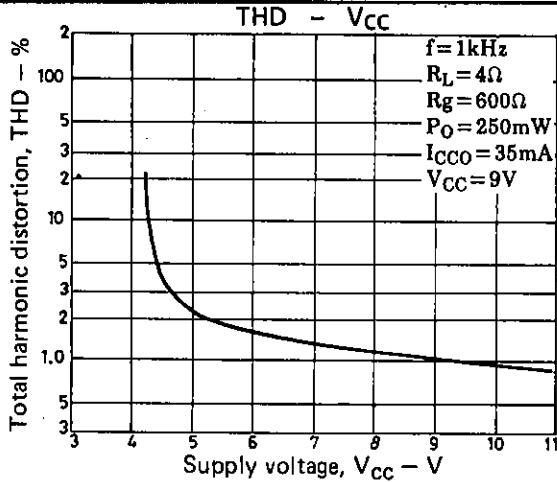

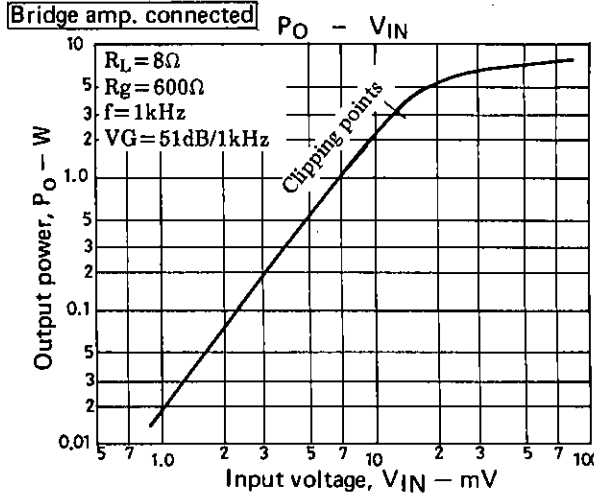
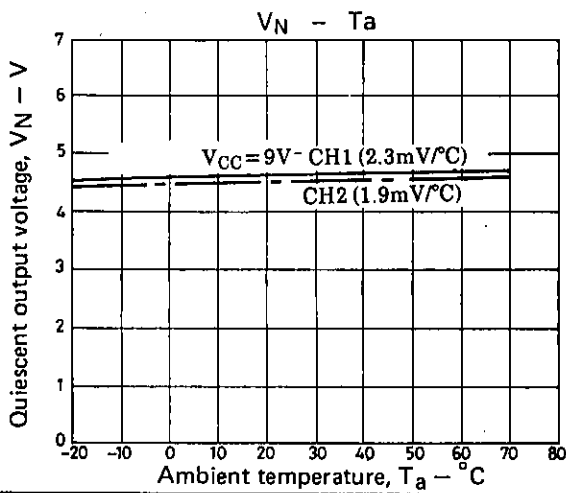
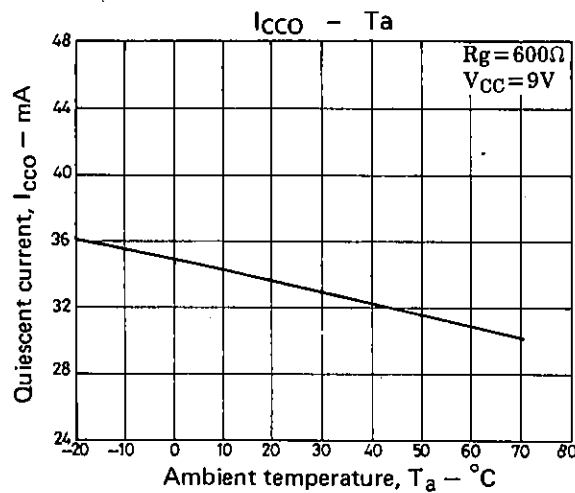
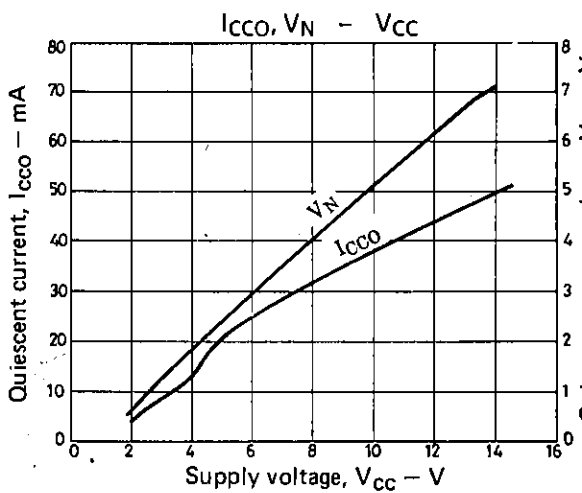
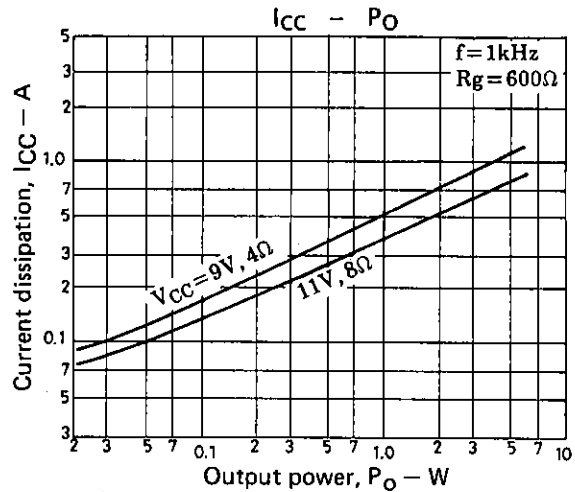
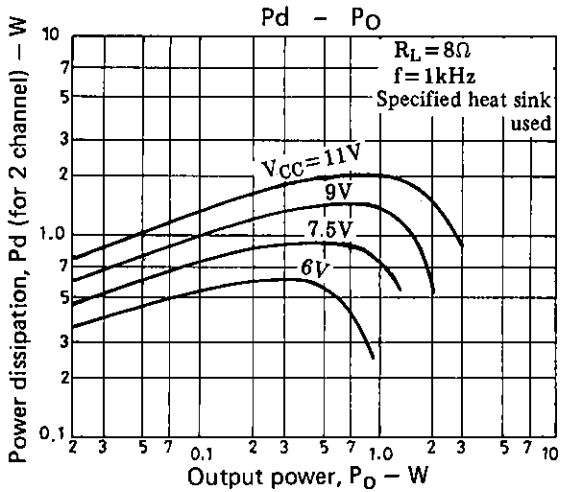
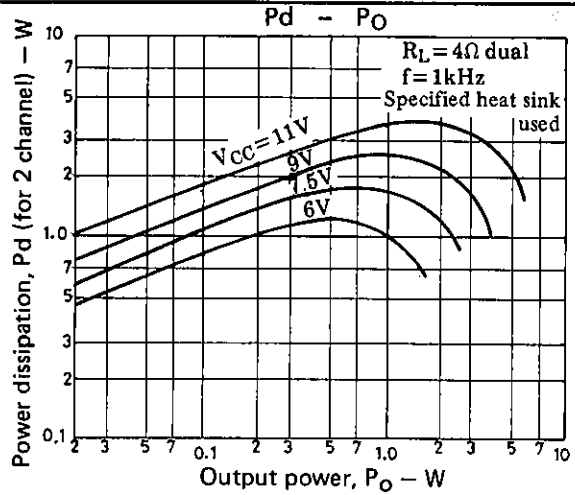
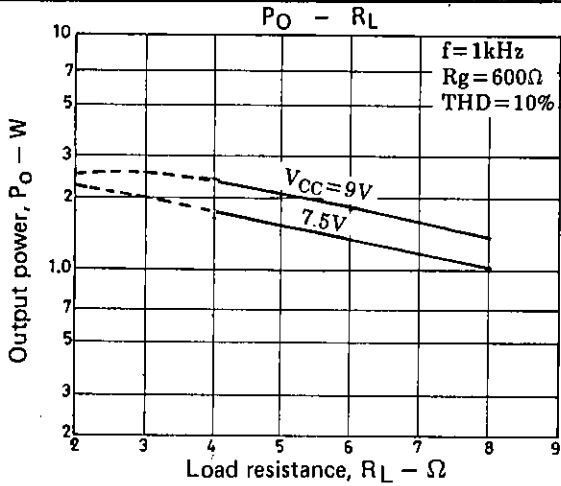

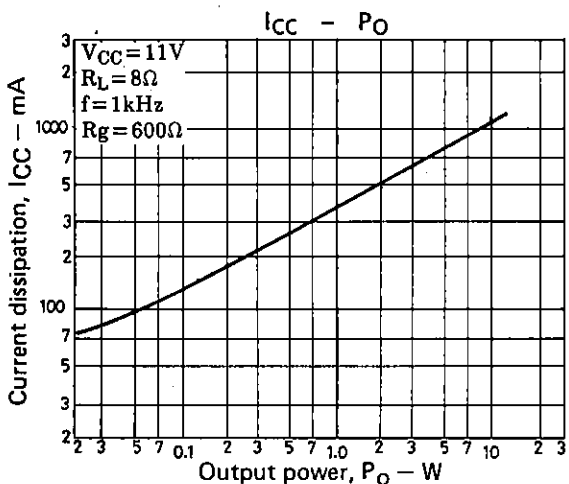
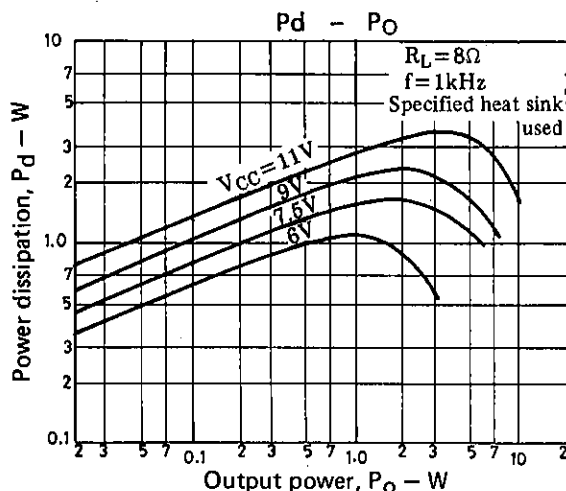
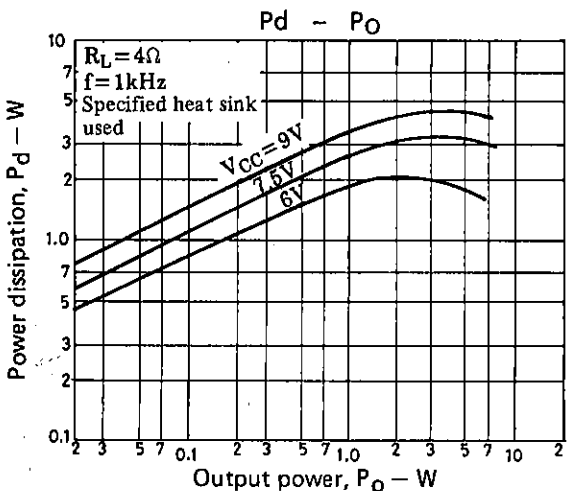
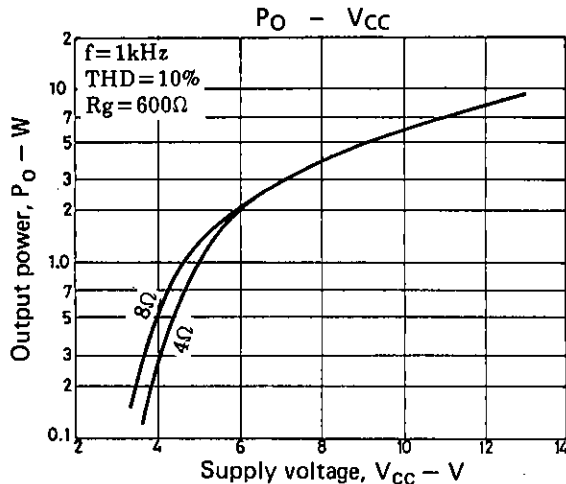
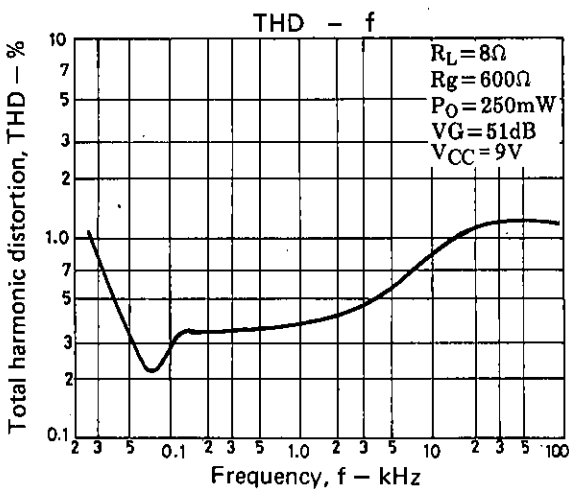
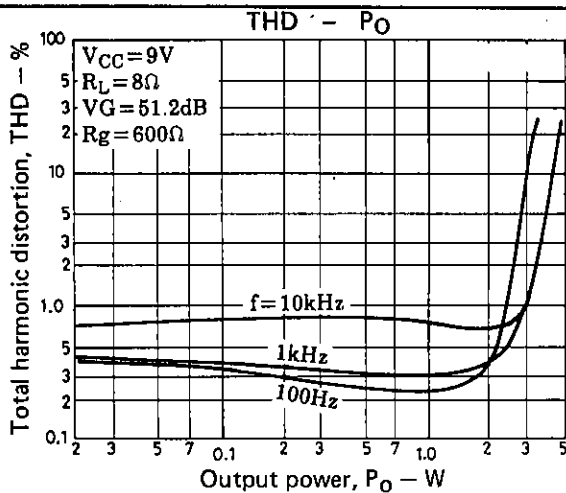
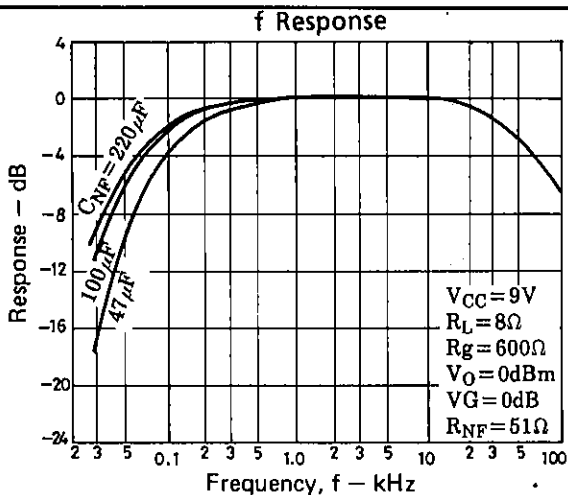

- No products described or contained herein are intended for use in surgical implants, life-support systems, aerospace equipment, nuclear power control systems, vehicles, disaster/crime-prevention equipment and the like, the failure of which may directly or indirectly cause injury, death or property loss.
- Anyone purchasing any products described or contained herein for an above-mentioned use shall:
 - ① Accept full responsibility and indemnify and defend SANYO ELECTRIC CO., LTD., its affiliates, subsidiaries and distributors and all their officers and employees, jointly and severally, against any and all claims and litigation and all damages, cost and expenses associated with such use.
 - ② Not impose any responsibility for any fault or negligence which may be cited in any such claim or litigation on SANYO ELECTRIC CO., LTD., its affiliates, subsidiaries and distributors or any of their officers and employees jointly or severally.
- Information (including circuit diagrams and circuit parameters) herein is for example only; it is not guaranteed for volume production. SANYO believes information herein is accurate and reliable, but no guarantees are made or implied regarding its use or any infringements of intellectual property rights or other rights of third parties.