

**LA4446**

Car Stereo-Use 5.5W 2-Channel AF Power Amplifier

Features

- Dual channels.
Output : 5.5W×2 (typ.)
- Low pop noise at the time of power supply ON/OFF and good starting balance.
- Good ripple rejection : 46dB (typ.)
- Good channel separation.
- Low residual noise (Rg=0).
- On-chip protectors.
 - a. Thermal protector
 - b. Overvoltage/surge protector
 - c. Adjacent pins (7-8, 6-7) short protector

Package Dimensions

unit:mm

3107-SIP13H

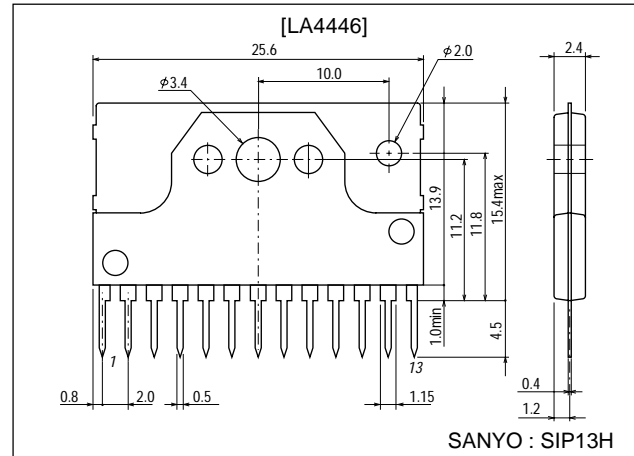

Specifications

Absolute Maximum Ratings at Ta = 25°C

Parameter	Symbol	Conditions	Ratings	Unit
Maximum supply voltage	V _{CC} max1	Quiescent (t=30s)	25	V
	V _{CC} max2	Operating	18	V
Surge supply voltage	V _{CC} surge	t≤0.2s	50	V
Maximum output current	I _O peak	Per channel	3.5	A
Allowable power dissipation	Pd max	See Pd max – Ta characteristic.	15	W
Operating temperature	T _{opr}		-20 to +75	°C
Storage temperature	T _{stg}		-40 to +150	°C

Operating Conditions at Ta = 25°C

Parameter	Symbol	Conditions	Ratings	Unit
Recommended supply voltage	V _{CC}		13.2	V
Recommended load resistance	R _L	2 channels	4	Ω
Operating voltage range	V _{CC} op		10 to 16	V

■ Any and all SANYO products described or contained herein do not have specifications that can handle applications that require extremely high levels of reliability, such as life-support systems, aircraft's control systems, or other applications whose failure can be reasonably expected to result in serious physical and/or material damage. Consult with your SANYO representative nearest you before using any SANYO products described or contained herein in such applications.

■ SANYO assumes no responsibility for equipment failures that result from using products at values that exceed, even momentarily, rated values (such as maximum ratings, operating condition ranges, or other parameters) listed in products specifications of any and all SANYO products described or contained herein.

SANYO Electric Co., Ltd. Semiconductor Company

TOKYO OFFICE Tokyo Bldg., 1-10, 1 Chome, Ueno, Taito-ku, TOKYO, 110-8534 JAPAN

LA4446

Operating Characteristics at $T_a = 25^\circ\text{C}$, $V_{CC} = 13.2\text{V}$, $R_L = 4\Omega$, $f = 1\text{kHz}$, $R_g = 600\Omega$, with $100 \times 100 \times 1.5\text{mm}^3$ Al heat sink

Parameter	Symbol	Conditions	Ratings			Unit
			min	typ	max	
Quiescent current	I_{CCO}			75	150	mA
Voltage gain	VG		49.5	51.5	53.5	dB
Output power	P_O	THD=10%, 2 channels	5.0	5.5		W
Total harmonic distortion	THD	$P_O = 1\text{W}$		0.2	1.0	%
Input resistance	r_i			30		$k\Omega$
Output noise voltage	V_{NO}	$R_g = 0$		0.6	1.0	mV
		$R_g = 10k\Omega$		1.0	2.0	mV
Ripple rejection	SVRR	$R_g = 0$, $V_{CCR} = 200\text{mV}$, $f_r = 100\text{Hz}$		46		dB
Channel separation	CH sep	$R_g = 10k\Omega$, $V_o = 0\text{dBm}$	45	55		dB

Equivalent Circuit Block Diagram

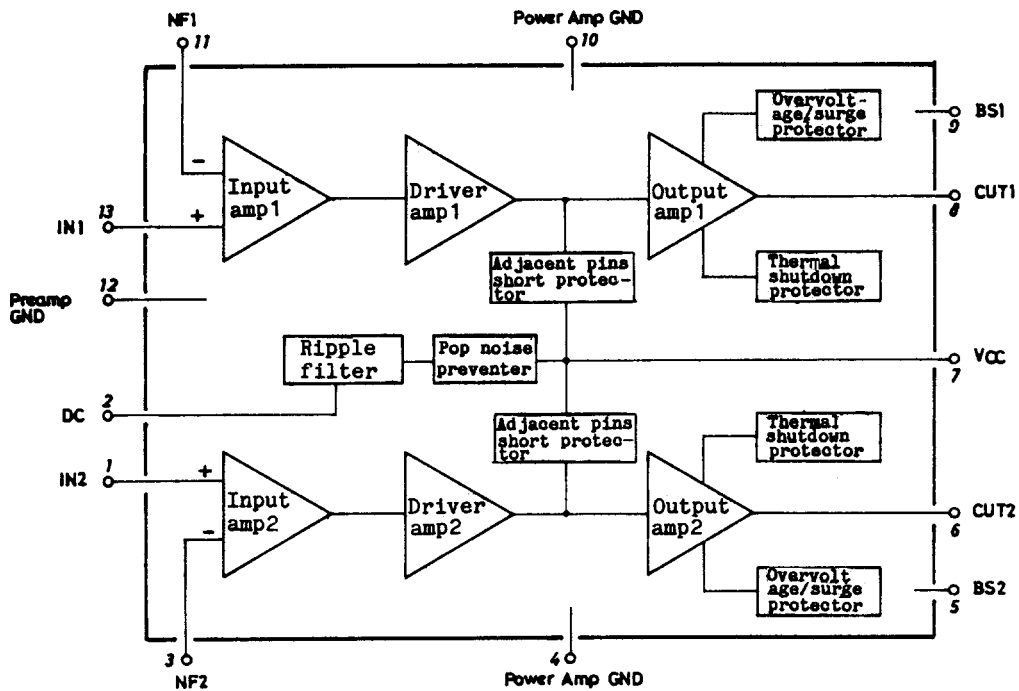

Sample Application Circuit

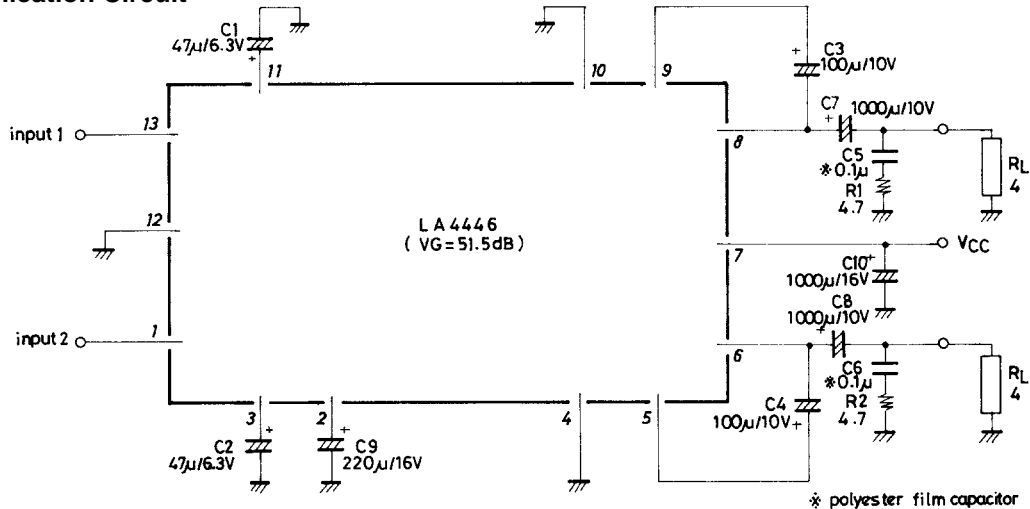

Unit (resistance: Ω , capacitance: F)

LA4446

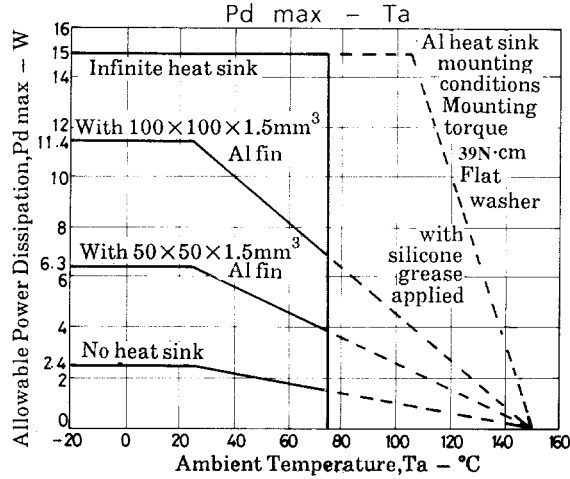

Sample Printed Circuit Pattern (Cu-foiled area)

Unit (resistance: Ω , capacitance: F)

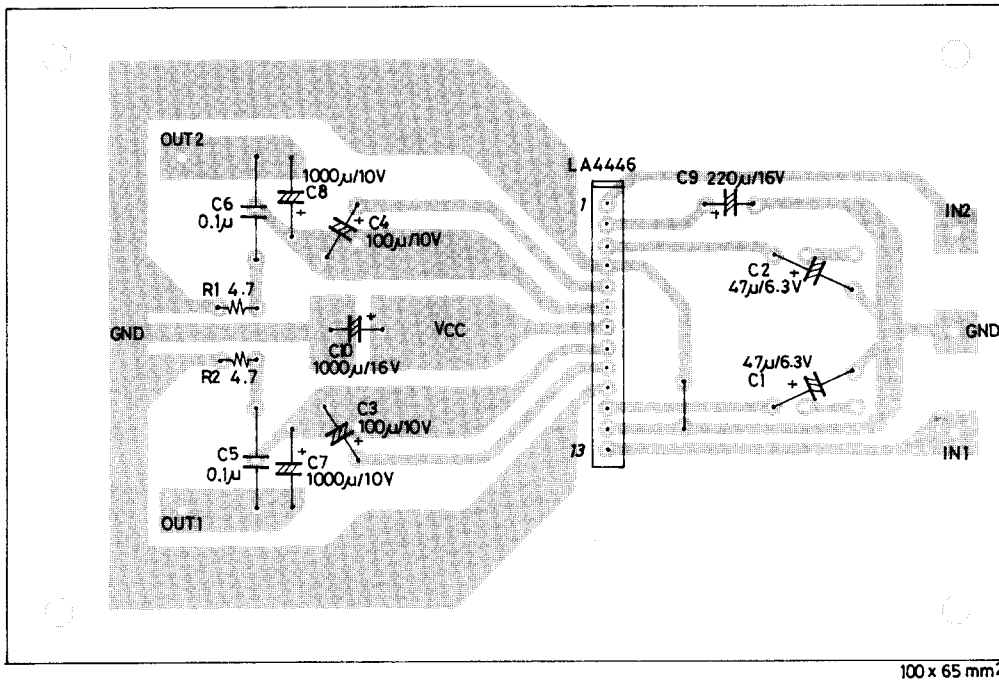

* Mounting the heat sink, use a flat screw. Mounting torque : 39 to 59N · cm

Features of IC System

- 2-channel use.
- Decoupling capacitor C9=220 μ F is used to reject ripple and determine the delay time at the time of application of power.
- A low roll-off frequency depends on the NF capacitor. Refer to the graph. To extend f_L , the output capacitor must be also considered.
- To make the pop noise much less, connect R_{NF}' to NF capacitors C1, C2 to decrease the gain.

$$VG \approx 20 \log \frac{R_f}{R_{NF}} \quad [\text{dB}] \quad R_{NF} \approx 50\Omega, R_f = 20\text{k}\Omega \text{ on chip}$$

When $R_{NF}' = 50\Omega$ is connected to NF capacitors C1, C2 externally, the gain becomes approximately 46dB. When $R_{NF}' = 150\Omega$ is connected additionally, the gain becomes approximately 40dB.

- Ripple rejection, total harmonic distortion, and oscillation depend on the layout of the printed circuit board. Large-signal GND, small-signal GND processing and parts GND points must be considered particularly.
- When providing external audio muting intentionally, the IC can be out off by connecting decoupling pin ② to GND through limiting resistor 50 to 100 Ω .

Continued on next page.

LA4446

Continued from preceding page.

- The V_{CCout} pin adjacent to other pins with a space of 2mm pitch is liable to undergo breakdown caused by solder bridge in the manufacturing process. Therefore, pins ⑦-⑧, ⑦-⑥ DC short protectors are contained. The LA4446 is designed to operate from car-use voltage regulation 10.5 to 15.6V.
- Overvoltage/surge protector.
Used to withstand giant pulses of positive surge 50V/200ms. The test is conducted based on the JASO standard in principle. The overvoltage protector is activated at $V_{CCX} \approx 24.5V$.
- Thermal protector.
Used to prevent instantaneous breakdown of the IC that may be caused by improper thermal design or abnormal state such as AC load short. The thermal protector is activated at $T_j = 160^\circ C$.

2-Channel Characteristics

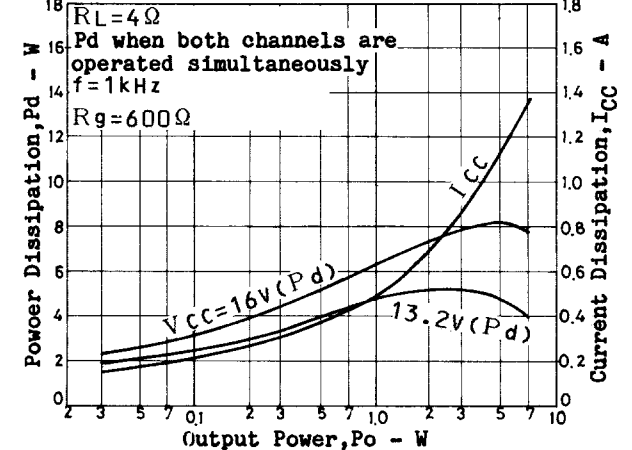
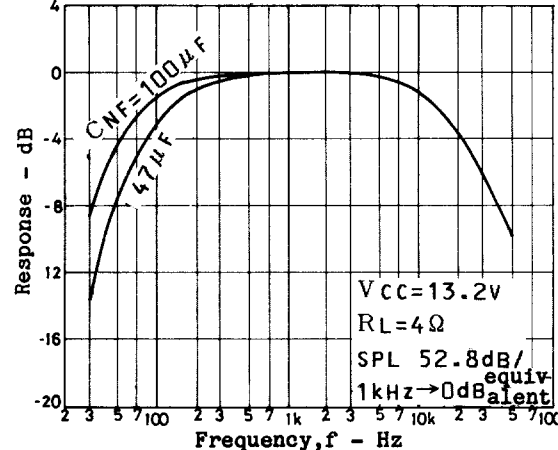
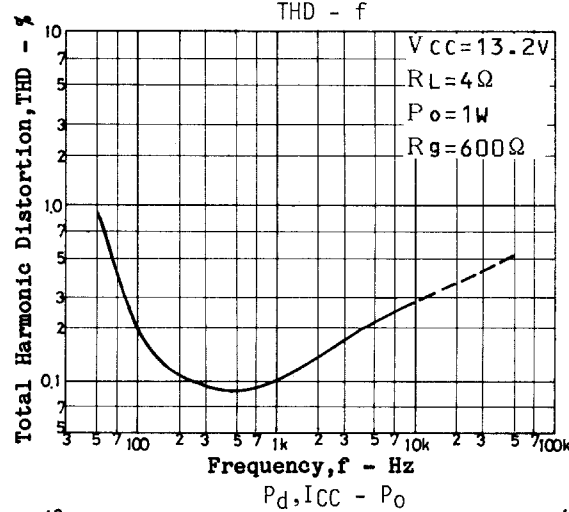
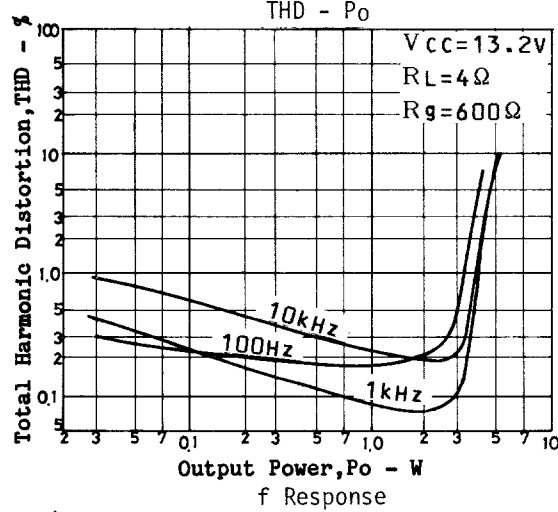
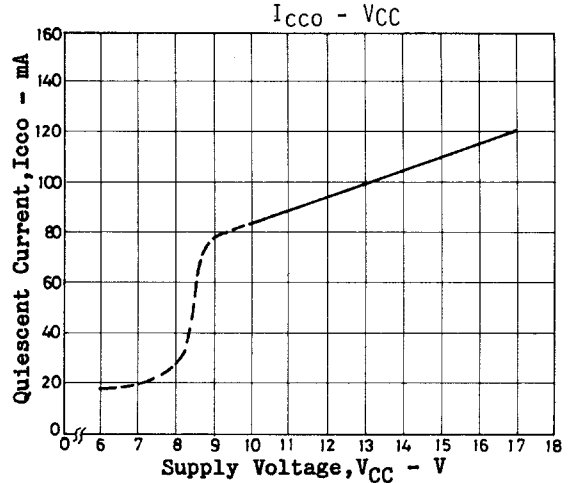
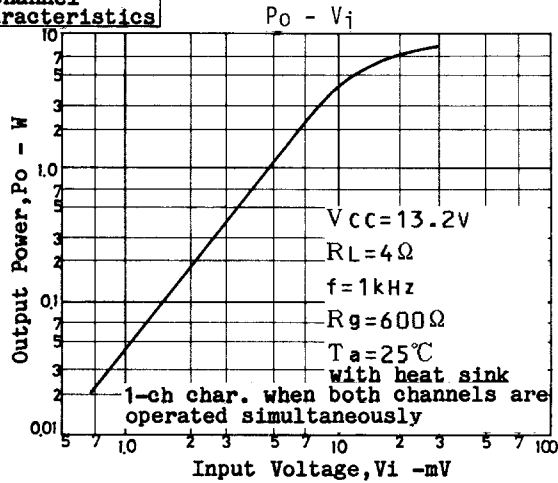

LA4446

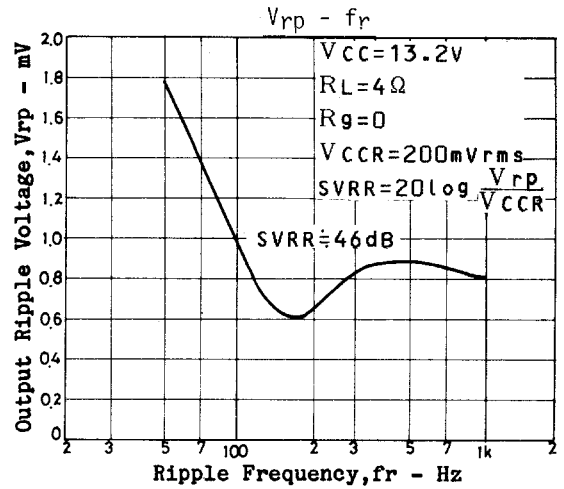
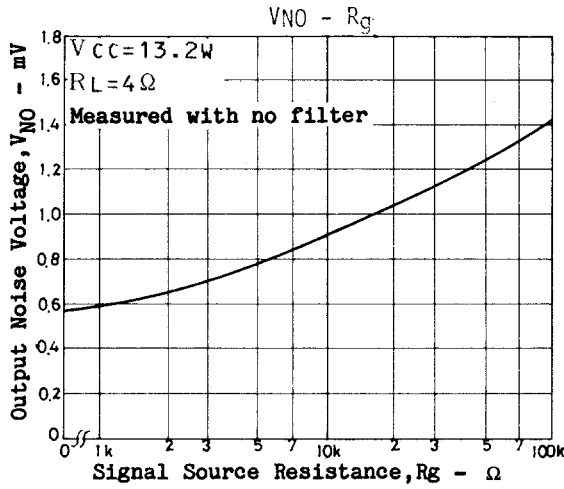
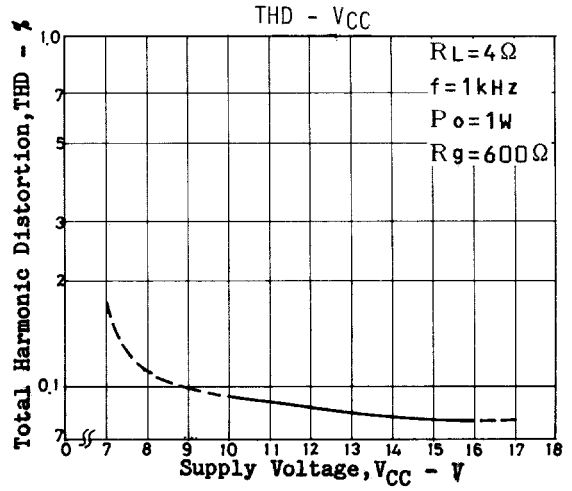
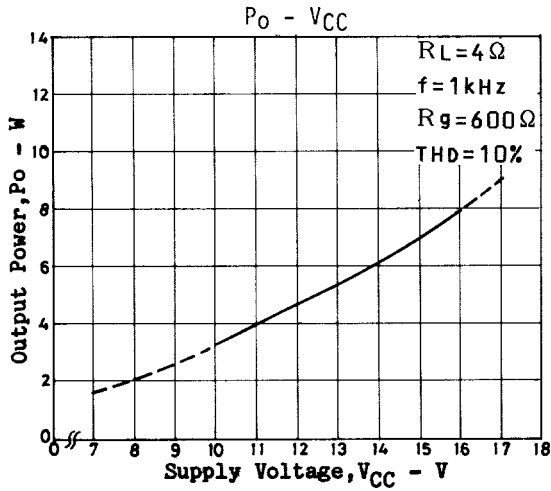

Sample BTL

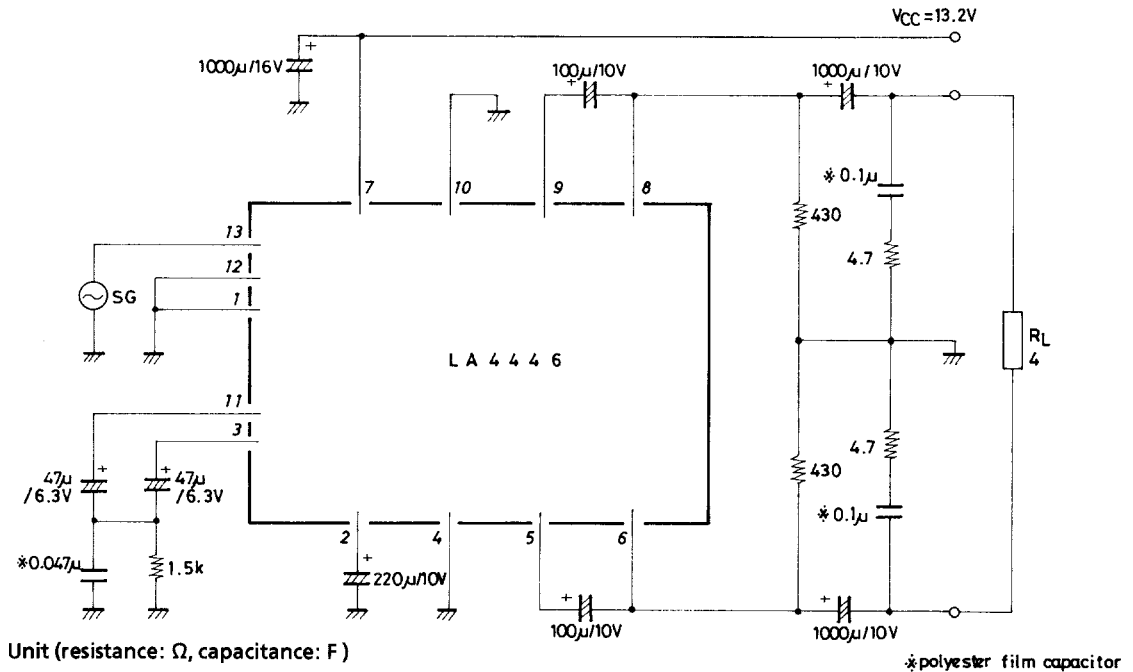

LA4446

BTL Characteristics

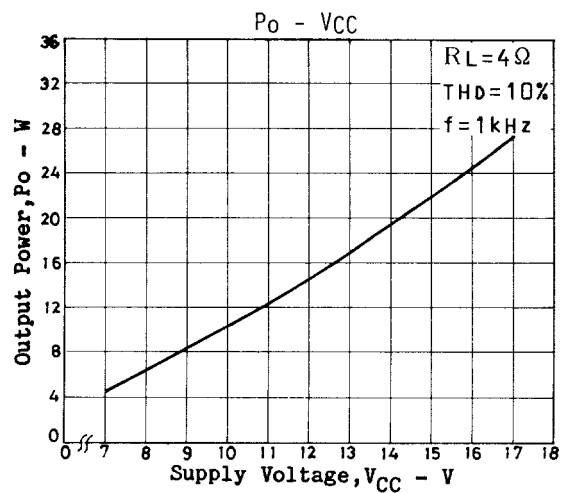
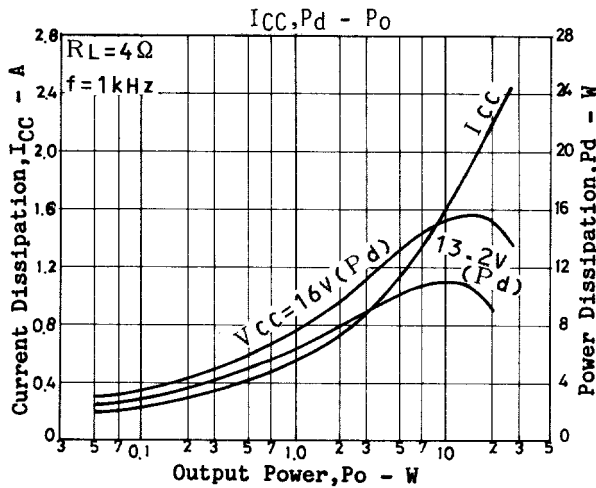
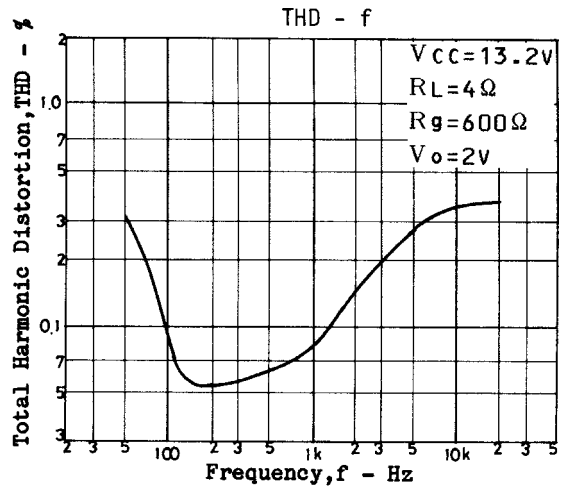
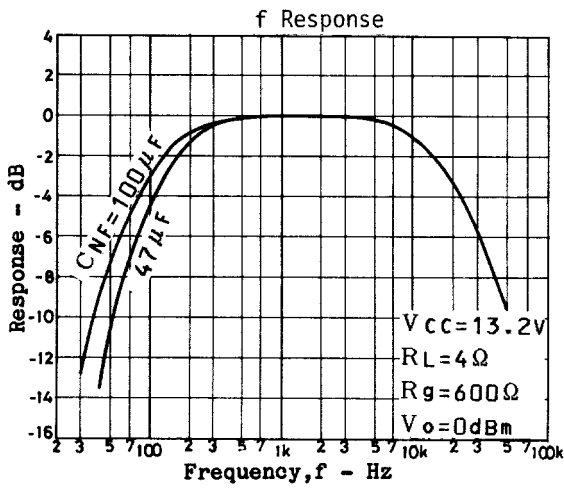
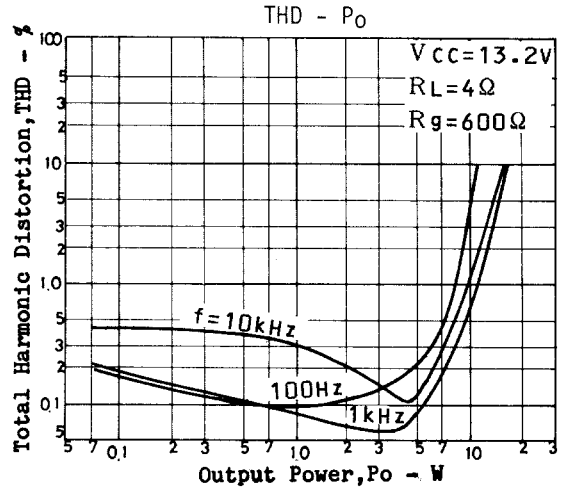
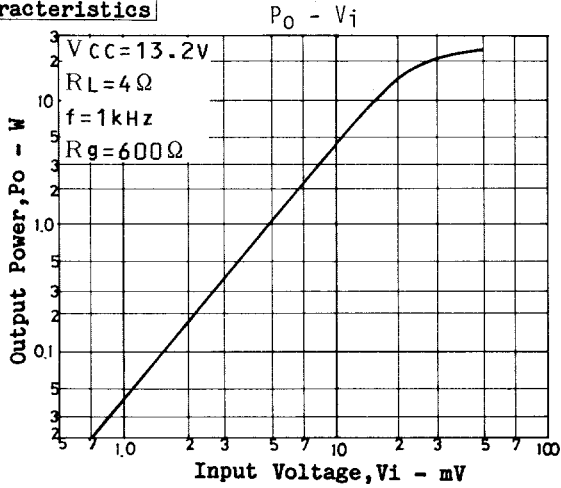

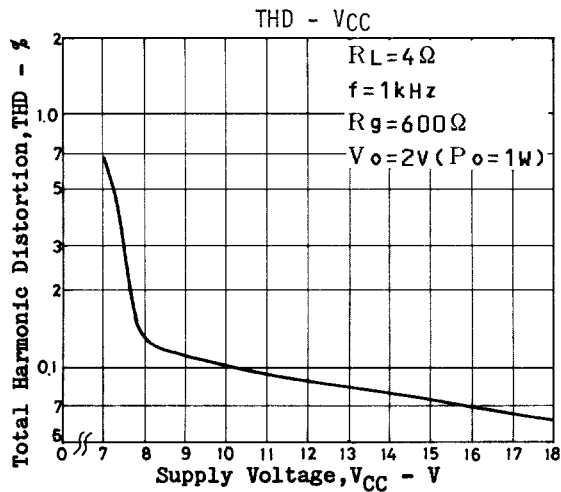

- Specifications of any and all SANYO products described or contained herein stipulate the performance, characteristics, and functions of the described products in the independent state, and are not guarantees of the performance, characteristics, and functions of the described products as mounted in the customer's products or equipment. To verify symptoms and states that cannot be evaluated in an independent device, the customer should always evaluate and test devices mounted in the customer's products or equipment.
- SANYO Electric Co., Ltd. strives to supply high-quality high-reliability products. However, any and all semiconductor products fail with some probability. It is possible that these probabilistic failures could give rise to accidents or events that could endanger human lives, that could give rise to smoke or fire, or that could cause damage to other property. When designing equipment, adopt safety measures so that these kinds of accidents or events cannot occur. Such measures include but are not limited to protective circuits and error prevention circuits for safe design, redundant design, and structural design.
- In the event that any or all SANYO products (including technical data, services) described or contained herein are controlled under any of applicable local export control laws and regulations, such products must not be exported without obtaining the export license from the authorities concerned in accordance with the above law.
- No part of this publication may be reproduced or transmitted in any form or by any means, electronic or mechanical, including photocopying and recording, or any information storage or retrieval system, or otherwise, without the prior written permission of SANYO Electric Co., Ltd.
- Any and all information described or contained herein are subject to change without notice due to product/technology improvement, etc. When designing equipment, refer to the "Delivery Specification" for the SANYO product that you intend to use.
- Information (including circuit diagrams and circuit parameters) herein is for example only; it is not guaranteed for volume production. SANYO believes information herein is accurate and reliable, but no guarantees are made or implied regarding its use or any infringements of intellectual property rights or other rights of third parties.

This catalog provides information as of February, 2000. Specifications and information herein are subject to change without notice.