

TDA 1037

AF Power Amplifier IC

with Thermal Shutdown

AF power amplifier designed for a wide range of supply voltages to enable versatile application in entertainment electronics. The amplifier operates in the push-pull B mode and is available in the SIP 9 package. The integrated shutdown protects the IC from overheating.

Features

- Wide supply voltage range: 4 V to 28 V
- High output power up to 8 W
- Large output current up to 2.5 A
- Simple mounting

Maximum ratings

Supply voltage	$R_L \geq 16 \Omega$	V_S	30	V
	$R_L \geq 8 \Omega$	V_S	24	V
	$R_L \geq 4 \Omega$	V_S	20	V
Output peak current (not repetitive)		I_{q1}	3.5	A
Output current (repetitive)		I_{q1}	2.5	A
Junction temperature ¹⁾		T_j	150	°C
Storage temperature range		T_{stg}	-40 to 125	°C
Thermal resistance				
junction-case		R_{thJC}	12	K/W
system-air		R_{thSA}	70	K/W

Operating range

Supply voltage		V_S	4 to 28	V
Ambient temperature		T_A	-25 to 85	°C

¹⁾ May not be exceeded even as instantaneous value.

Characteristics

with reference to test circuit

1. $V_S = 12\text{ V}$; $R_L = 4\ \Omega$; $C_1 = 1000\ \mu\text{F}$; $f_i = 1\text{ kHz}$; $T_A = 25\text{ }^\circ\text{C}$

		min	typ	max	
Quiescent output voltage	V_{q2}	5.4	6.0	6.6	V
Quiescent drain current	$I_3 + I_4$		12	20	mA
Input DC current	I_{i8}		0.4	4	μA
Output power $THD = 1\%$	P_q	2.5	3.5		W
$THD = 10\%$	P_q	3.5	4.5		W
Voltage gain (closed loop)	G_V	37	40	43	dB
Voltage gain (open loop)	G_{V0}		80		dB
Total harmonic distortion ($P_q = 0.05$ to 2.5 W)	THD		0.2		%
Noise voltage referred to input ($f_i = 3\text{ Hz}$ to 20 kHz)	V_n		3.8	10	μV_S
Disturbance voltage in acc. with DIN 45405 referred to input	V_d		2.5		μV
Hum suppression ($f_{hum} = 100\text{ Hz}$)	a_{hum}		48		dB
Frequency range (-3 dB)					
$C_4 = 560\text{ pF}$	f	40		20,000	Hz
$C_4 = 1000\text{ pF}$	f	40		10,000	Hz
Input resistance	R_{i8}	1	5		M Ω

2. $V_S = 24\text{ V}$; $R_L = 16\ \Omega$; $C_1 = 220\ \mu\text{F}$; $f_i = 1\text{ kHz}$; $T_A = 25\text{ }^\circ\text{C}$

Quiescent output voltage	V_{q2}	11	12	13	V
Quiescent drain current	$I_3 + I_4$		18	30	mA
Input DC current	I_{i8}		0.8	8	μA
Output power $THD = 1\%$	P_q		3.5		W
$THD = 10\%$	P_q	4.5	5.0		W
Voltage gain (closed loop)	G_V	37	40	43	dB
Voltage gain (open loop)	G_{V0}		80		dB
Total harmonic distortion ($P_q = 0.05$ to 3 W)	THD		0.2	0.5	%
Noise voltage with reference to input $f_i = 3\text{ Hz}$ to 20 kHz	V_n		5	15	μV_S
Disturbance voltage in acc. with DIN 45405 referred to input	V_d		3.8		μV
Hum suppression ($f_{hum} = 100\text{ Hz}$)	a_{hum}		40		dB
Frequency range (-3 dB)					
$C_4 = 560\text{ pF}$	f	40		20,000	Hz
$C_4 = 1000\text{ pF}$	f	40		10,000	Hz
Input resistance	R_{i8}	1	5		M Ω

Circuit diagram

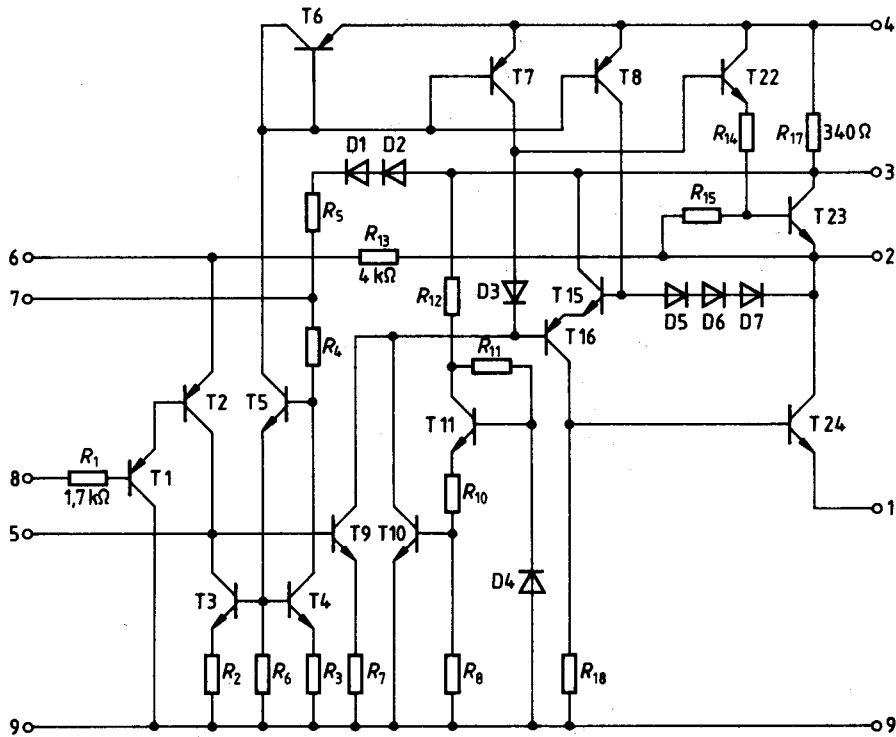

Measurement circuit

8

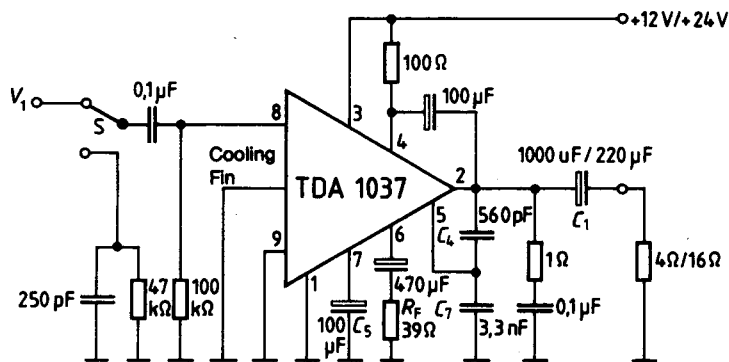

S Closed for Noise Measurement

Application circuit

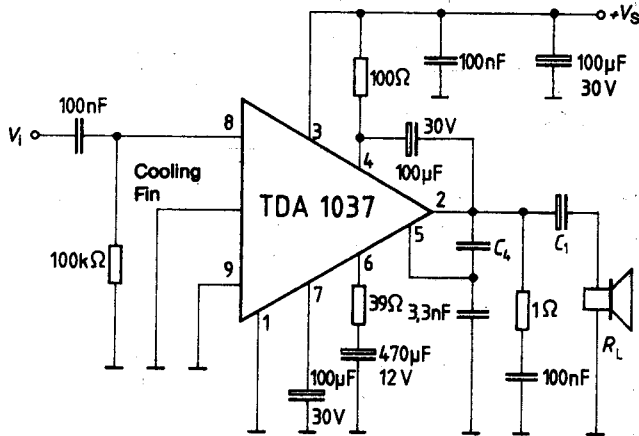

V_S	12 V	18 V	24 V
R_L	4 Ω	8 Ω	16 Ω
C_1	1000 μF	470 μF	220 μF

f_{max}	10 kHz	20 kHz
C_4	1000 pF	560 pF

Output power versus supply voltage
 THD = 10%; $R_L = 4, 8, 16 \Omega$; $f = 1 \text{ kHz}$

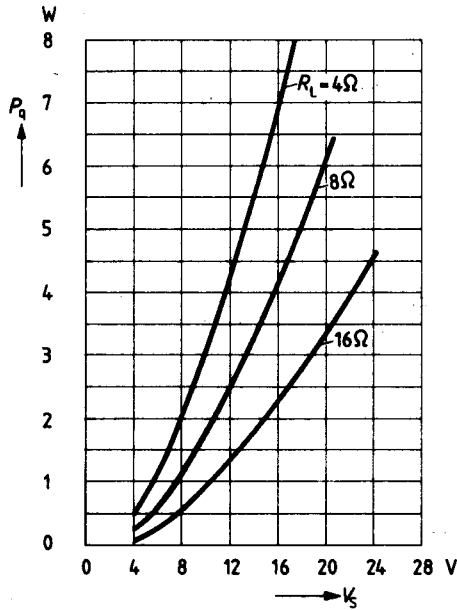

Max. power dissipation versus supply voltage at sine-shaped driving
 $f = 1 \text{ kHz}$; $R_L = 4, 8, 16 \Omega$, THD = 10%

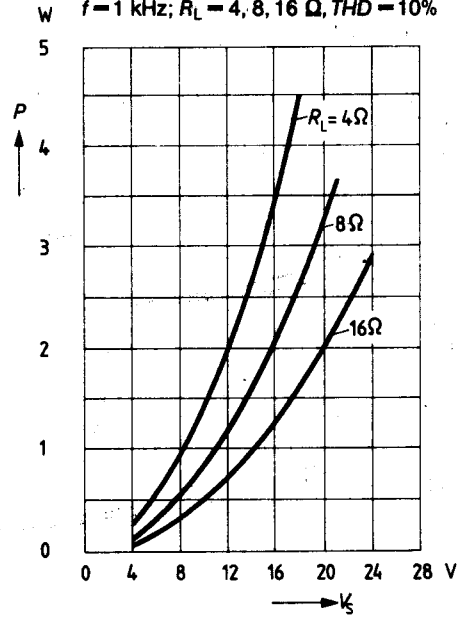

Total power dissipation and efficiency versus output power
 THD = 10%; $f = 1 \text{ kHz}$

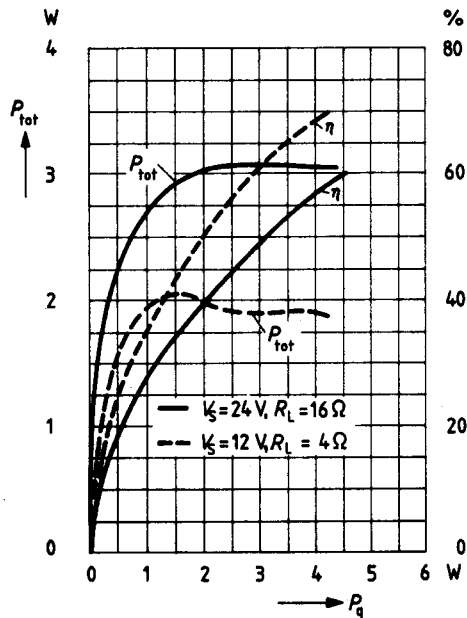

Quiescent drain current, quiescent current of output transistors, quiescent output voltage versus supply voltage

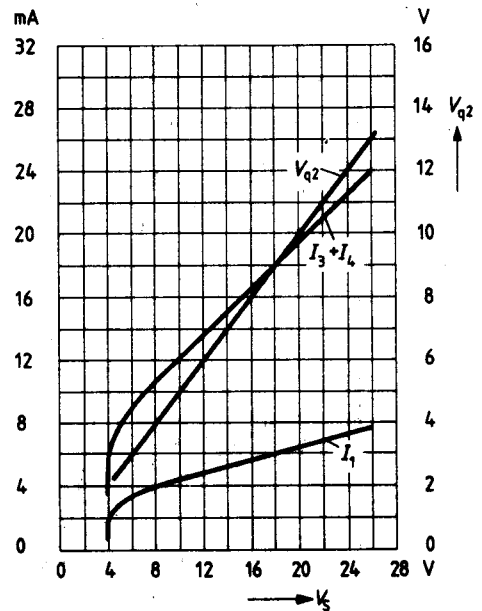

Hum suppression versus feedback resistance

$f_{\text{hum}} = 100 \text{ Hz}; C_S = 100 \text{ } \mu\text{F}$

a: input short-circuited

b: input open

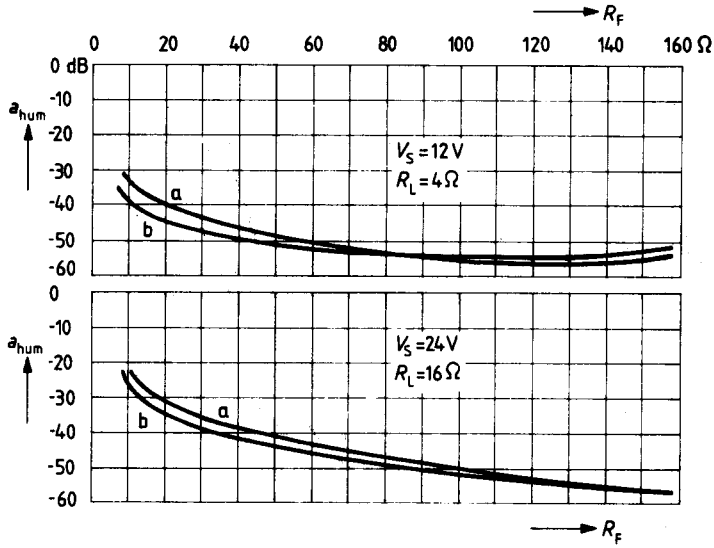

Max. total power dissipation versus ambient temperature

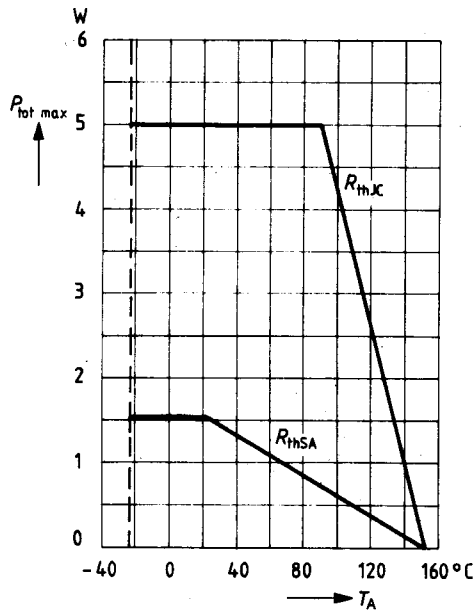

**Total harmonic distortion
versus output power**
 $f = 1 \text{ kHz}$

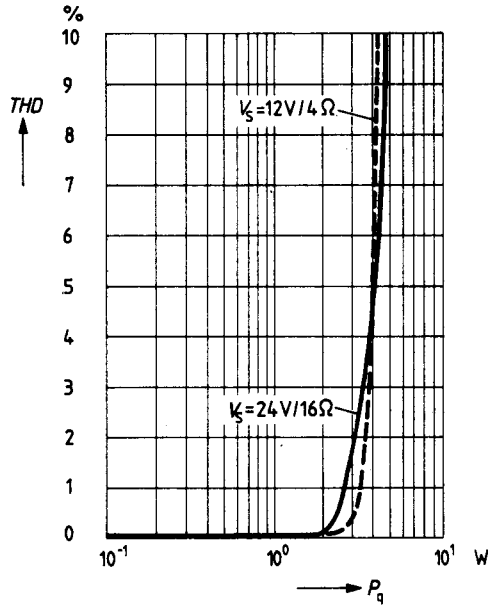

Total harmonic distortion versus frequency

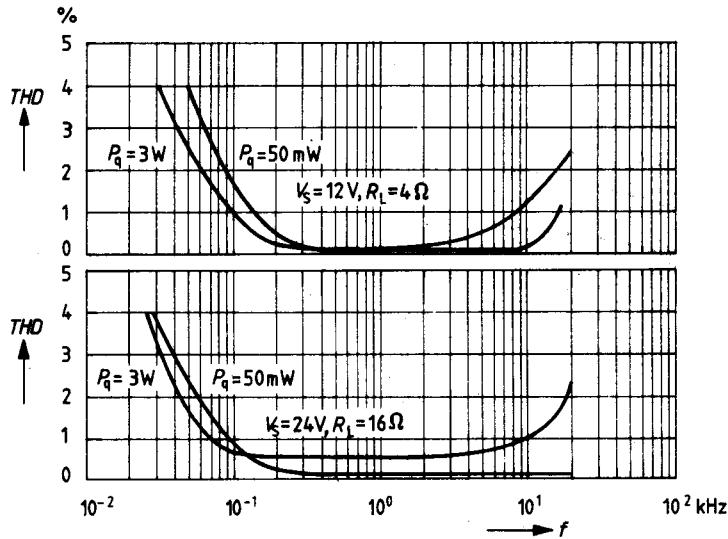

Voltage gain versus frequency

$V_S = 12\text{ V}; R_L = 4\ \Omega$

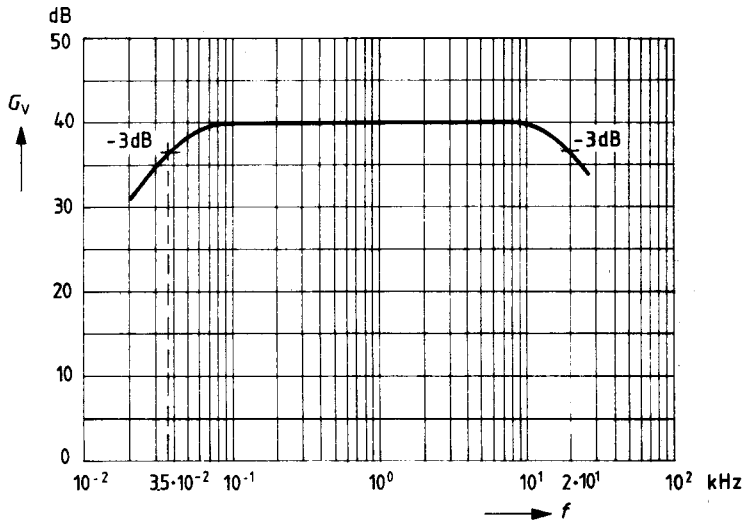

Bandwidth C_3 versus feedback resistance

$V_S = 12\text{ V}; R_L = 4\ \Omega, G_V = 40\text{ dB}$

$C_1 = 5 \cdot C_4$

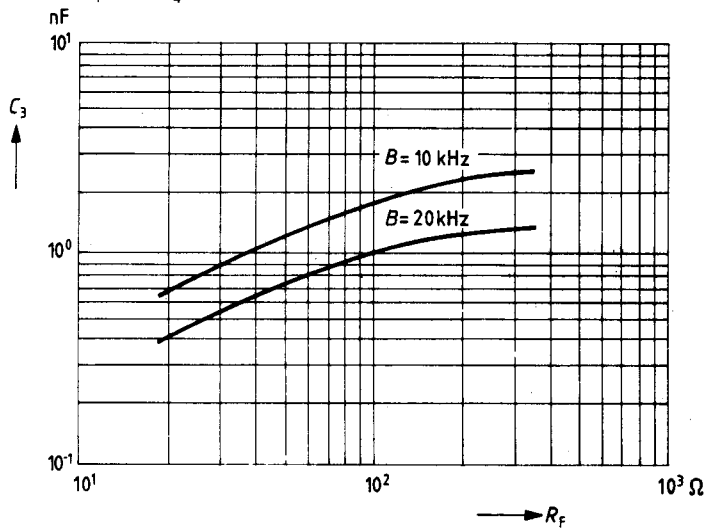

Output power and voltage gain versus feedback resistance and input voltage

$V_S = 12\text{ V}; R_L = 4\ \Omega; f = 1\text{ kHz}$

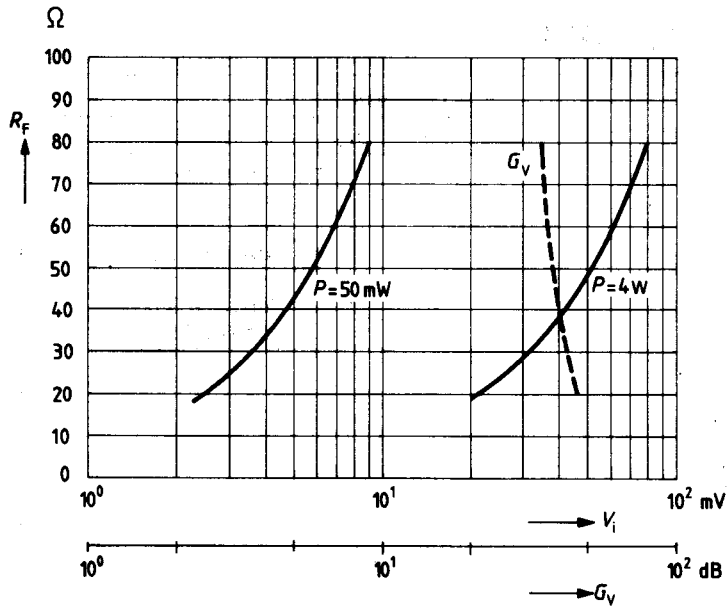

Output power versus feedback resistance and input voltage

$V_S = 24\text{ V}; R_L = 16\ \Omega; f = 1\text{ kHz}$

