



Dual N-Channel 2.5-V (G-S) MOSFET Common Drain, ESD Protection

PRODUCT SUMMARY		
V_{DS} (V)	$r_{DS(on)}$ (Ω)	I_D (A)
20	0.022 @ $V_{GS} = 4.5$ V	± 6.5
	0.030 @ $V_{GS} = 2.5$ V	± 5.5

FEATURES

- TrenchFET® Power MOSFET
- ESD Protected: 3000 V

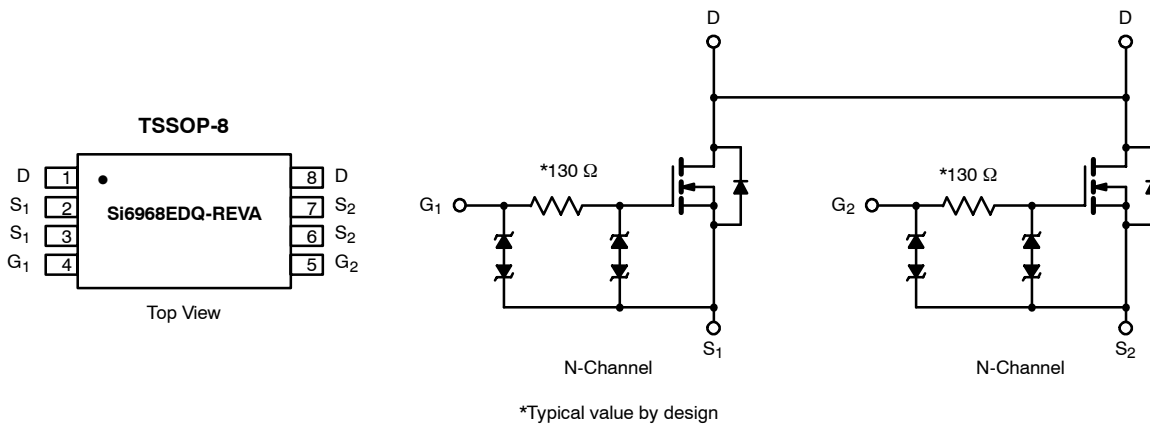

ABSOLUTE MAXIMUM RATINGS ($T_A = 25^\circ\text{C}$ UNLESS OTHERWISE NOTED)				
Parameter	Symbol	10 secs	Steady State	Unit
Drain-Source Voltage	V_{DS}	20		V
Gate-Source Voltage	V_{GS}	± 12		
Continuous Drain Current ($T_J = 150^\circ\text{C}$) ^a	I_D	$T_A = 25^\circ\text{C}$	± 6.5	A
		$T_A = 70^\circ\text{C}$	± 5.5	
Pulsed Drain Current	I_{DM}	± 30		A
Continuous Source Current (Diode Conduction) ^a	I_S	1.5	1.0	
Maximum Power Dissipation ^a	P_D	$T_A = 25^\circ\text{C}$	1.5	W
		$T_A = 70^\circ\text{C}$	0.96	
Operating Junction and Storage Temperature Range	T_J, T_{stg}	-55 to 150		$^\circ\text{C}$

THERMAL RESISTANCE RATINGS				
Parameter	Symbol	Typ	Max	Unit
Maximum Junction-to-Ambient ^a	R_{thJA}	$t \leq 10$ sec	72	$^\circ\text{C/W}$
		Steady-State	100	
Maximum Junction-to-Foot (Drain)	R_{thJF}	55	70	

Notes

a. Surface Mounted on FR4 Board, $t \leq 10$ sec.



SPECIFICATIONS ($T_J = 25^\circ\text{C}$ UNLESS OTHERWISE NOTED)

Parameter	Symbol	Test Condition	Min	Typ ^a	Max	Unit
Static						
Gate Threshold Voltage	$V_{GS(th)}$	$V_{DS} = V_{GS}, I_D = 250 \mu\text{A}$	0.6			V
Gate-Body Leakage	I_{GSS}	$V_{DS} = 0 \text{ V}, V_{GS} = \pm 4.5 \text{ V}$			± 200	nA
Zero Gate Voltage Drain Current	I_{DSS}	$V_{DS} = 16 \text{ V}, V_{GS} = 0 \text{ V}$			1	μA
		$V_{DS} = 16 \text{ V}, V_{GS} = 0 \text{ V}, T_J = 70^\circ\text{C}$			25	
On-State Drain Current ^b	$I_{D(on)}$	$V_{DS} \leq 5 \text{ V}, V_{GS} = 4.5 \text{ V}$	30			A
Drain-Source On-State Resistance ^b	$r_{DS(on)}$	$V_{GS} = 4.5 \text{ V}, I_D = 6.5 \text{ A}$		0.018	0.022	Ω
		$V_{GS} = 2.5 \text{ V}, I_D = 5.5 \text{ A}$		0.024	0.030	
Forward Transconductance ^b	g_{fs}	$V_{DS} = 10 \text{ V}, I_D = 6.5 \text{ A}$		25		S
Diode Forward Voltage ^b	V_{SD}	$I_S = 1.5 \text{ A}, V_{GS} = 0 \text{ V}$		0.71	1.2	V
Dynamic^a						
Total Gate Charge	Q_g	$V_{DS} = 10 \text{ V}, V_{GS} = 4.5 \text{ V}, I_D = 6.5 \text{ A}$		16	25	nC
Gate-Source Charge	Q_{gs}			2.5		
Gate-Drain Charge	Q_{gd}			5.5		
Turn-On Delay Time	$t_{d(on)}$	$V_{DD} = 10 \text{ V}, R_L = 10 \Omega$ $I_D \cong 1 \text{ A}, V_{GEN} = 4.5 \text{ V}, R_G = 6 \Omega$		140	210	ns
Rise Time	t_r			230	350	
Turn-Off Delay Time	$t_{d(off)}$			600	900	
Fall Time	t_f			450	700	

Notes

- a. For design aid only; not subject to production testing.
- b. Pulse test; pulse width $\leq 300 \mu\text{s}$, duty cycle $\leq 2\%$.

TYPICAL CHARACTERISTICS (25°C UNLESS NOTED)

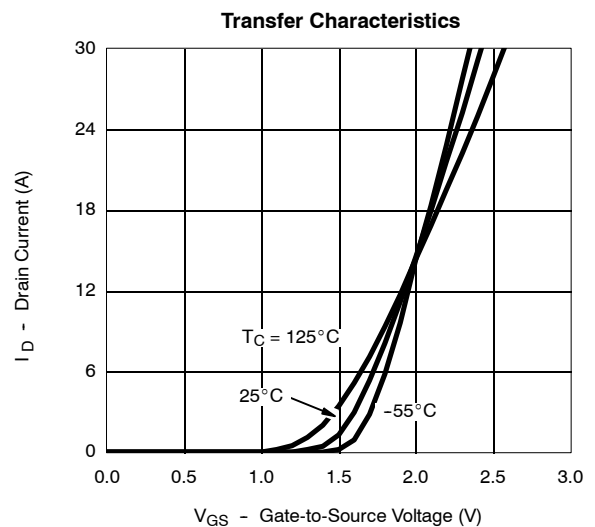
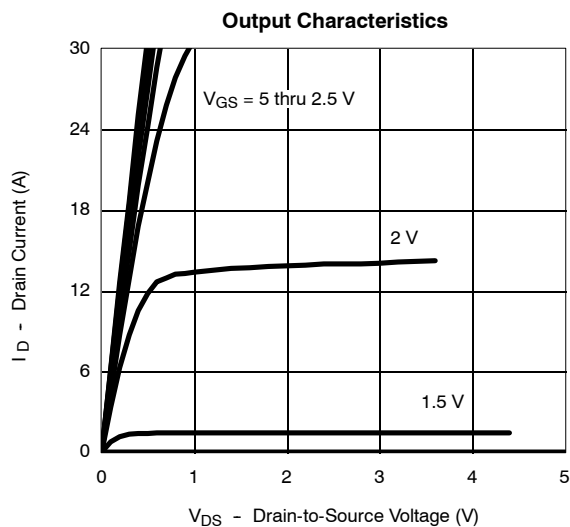



TYPICAL CHARACTERISTICS (25°C UNLESS NOTED)

On-Resistance vs. Drain Current

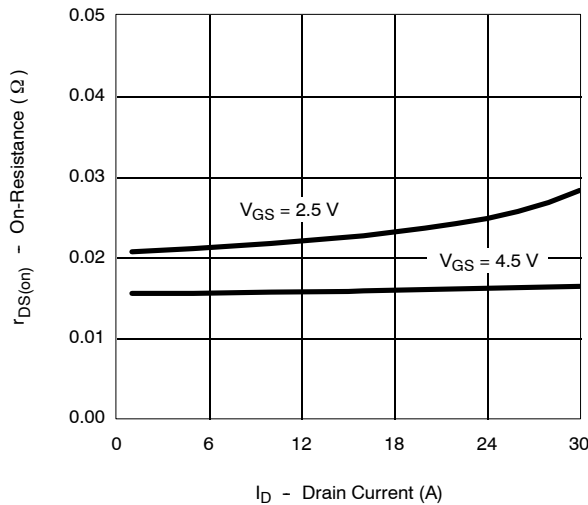

Gate Charge

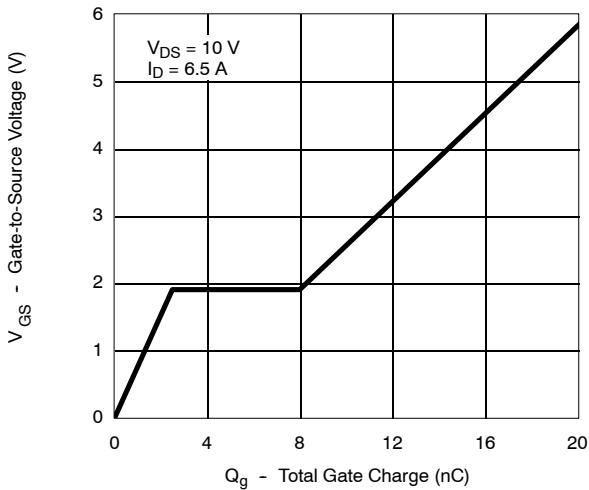

On-Resistance vs. Junction Temperature

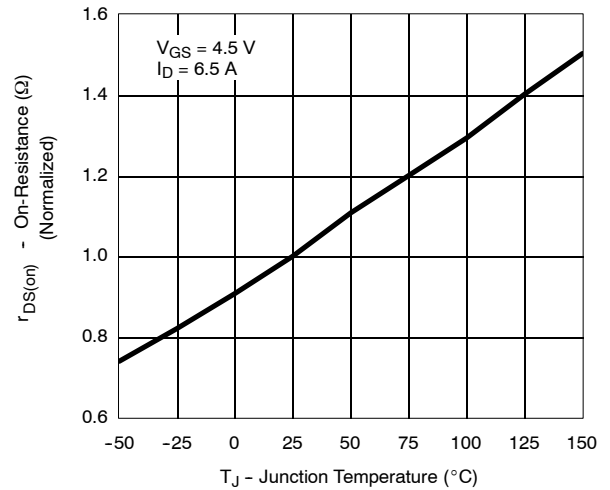

Source-Drain Diode Forward Voltage

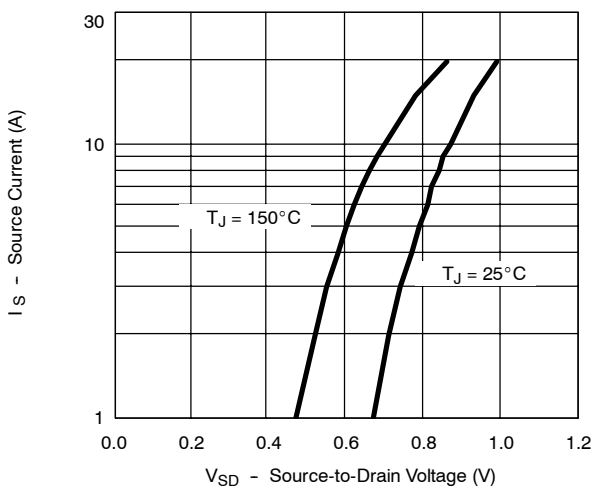

On-Resistance vs. Gate-to-Source Voltage

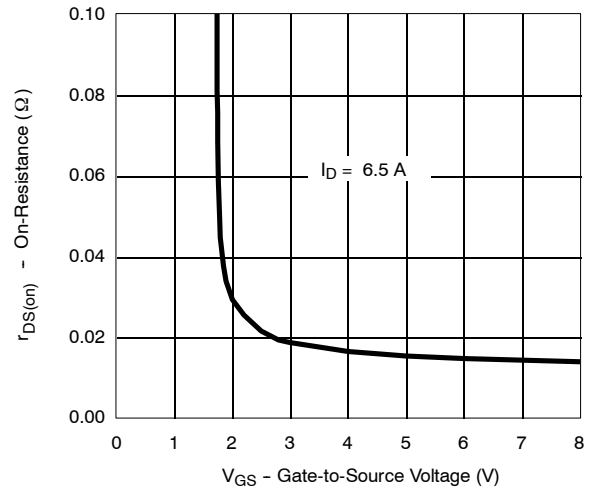

TYPICAL CHARACTERISTICS (25 °C UNLESS NOTED)

