

Features

- Industry-standard driver replacement
- Improved response times
- Matched rise and fall times
- Reduced clock skew
- Low output impedance
- Low input capacitance
- High noise immunity
- Improved clocking rate
- Low supply current
- Wide operating range
- Separate drain connections

Applications

- Clock/line drivers
- CCD drivers
- Ultrasound transducer drivers
- Power MOSFET drivers
- Switch mode power supplies
- Resonant charging
- Cascoded drivers

Ordering Information

Part No.	Package	Tape & Reel	Outline #
EL7154CN	8-Pin PDIP		MDP0031
EL7154CS	8-Pin SO		MDP0027

General Description

The EL7104C and EL7114C ICs are matched driver ICs that improve the operation of the industry-standard TC-4420/29 clock drivers. The Elantec versions are very high speed drivers capable of delivering peak currents of 1A into highly capacitive loads. The high speed performance is achieved by means of a proprietary "Turbo-Driver" circuit that speeds up input stages by tapping the wider voltage swing at the output. Improved speed and drive capability are enhanced by matched rise and fall delay times. These matched delays maintain the integrity of input-to-output pulse-widths to reduce timing errors and clock skew problems. This improved performance is accompanied by a 10-fold reduction in supply currents over bipolar drivers, yet without the delay time problems commonly associated with CMOS drivers.

Connection Diagrams

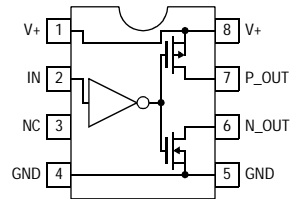

EL7104C
Non-inverting Driver

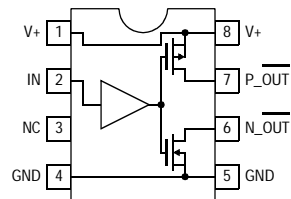

EL7114C
Inverting Driver

Note: All information contained in this data sheet has been carefully checked and is believed to be accurate as of the date of publication; however, this data sheet cannot be a "controlled document". Current revisions, if any, to these specifications are maintained at the factory and are available upon your request. We recommend checking the revision level before finalization of your design documentation.

EL7104C, EL7114C

High Speed, Single Channel, Power MOSFET Drivers

Absolute Maximum Ratings ($T_A = 25^\circ\text{C}$)

Supply (V+ to GND)	16.5V	Operating Junction Temperature	+125°C
Input Pins	-0.3V to +0.3V above V+	Power Dissipation:	
Peak Output Current	4A	SO	570mW
Storage Temperature Range	-65°C to +150°C	PDIP	1050mW
Ambient Operating Temperature	-40°C to +85°C		

Important Note:

All parameters having Min/Max specifications are guaranteed. Typ values are for information purposes only. Unless otherwise noted, all tests are at the specified temperature and are pulsed tests, therefore: $T_J = T_C = T_A$.

DC Electrical Characteristics

$T_A = 25^\circ\text{C}$, $V_+ = 15\text{V}$ unless otherwise specified.

Parameter	Description	Test Conditions	Min	Typ	Max	Unit
Input						
V_{IH}	Logic "1" Input Voltage		2.4			V
I_{IH}	Logic "1" Input Current	@V+		0.1	10	μA
V_{IL}	Logic "0" Input Voltage				0.8	V
I_{IL}	Logic "0" Input Current	@0V		0.1	10	μA
V_{HVS}	Input Hysteresis			0.3		V
Output						
R_{OH}	Pull-Up Resistance	$I_{OUT} = -100\text{ mA}$		1.5	4	Ω
R_{OL}	Pull-Down Resistance	$I_{OUT} = +100\text{ mA}$		2	4	Ω
I_{OUT}	Output Leakage Current	V+/GND		0.2	10	μA
I_{PK}	Peak Output Current	Source Sink		4.0 4.0		A
I_{DC}	Continuous Output Current	Source/Sink	200			mA
Power Supply						
I_S	Power Supply Current	Input = V+ EL7104C EL7114C		4.5 1	7.5 2.5	mA
V_S	Operating Voltage		4.5		16	V

AC Electrical Characteristics

$T_A = 25^\circ\text{C}$, $V = 15\text{V}$ unless otherwise specified.

Parameter	Description	Test Conditions	Min	Typ	Max	Unit
Switching Characteristics ($V_{DD} = V_H = 12\text{V}$; $V_L = -3\text{V}$)						
t_R	Rise Time	$C_L = 1000\text{ pF}$		7.5		ns
		$C_L = 2000\text{ pF}$		10	20	ns
t_F	Fall Time	$C_L = 1000\text{ pF}$		10		ns
		$C_L = 2000\text{ pF}$		15	20	ns
t_{D-ON}	Turn-On Delay Time	See Timing Table		18	25	ns
t_{D-OFF}	Turn-Off Delay Time	See Timing Table		18	25	ns

EL7104C, EL7114C

High Speed, Single Channel, Power MOSFET Drivers

EL7104C, EL7114C

Timing Table

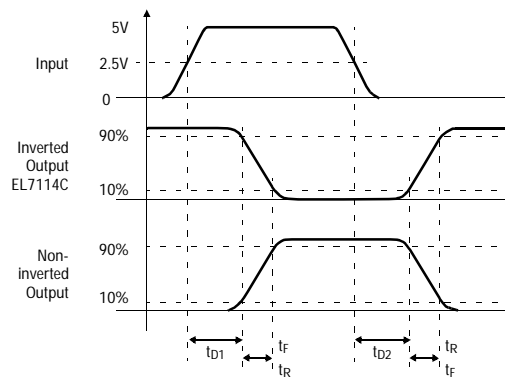

Standard Test Configuration

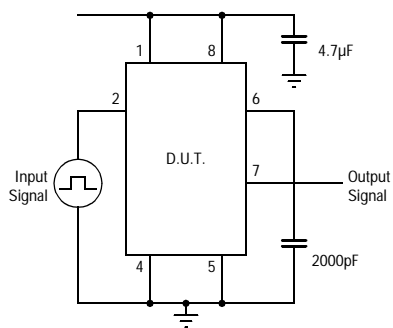

EL7104C, EL7114C

High Speed, Single Channel, Power MOSFET Drivers

EL7104C Simplified Schematic

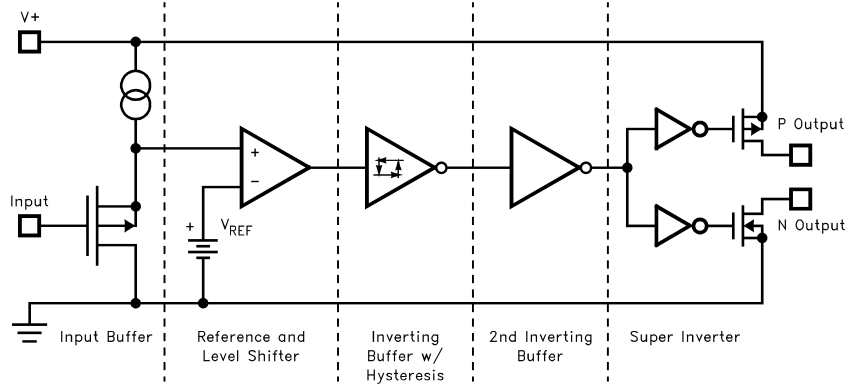

EL7114C Simplified Schematic

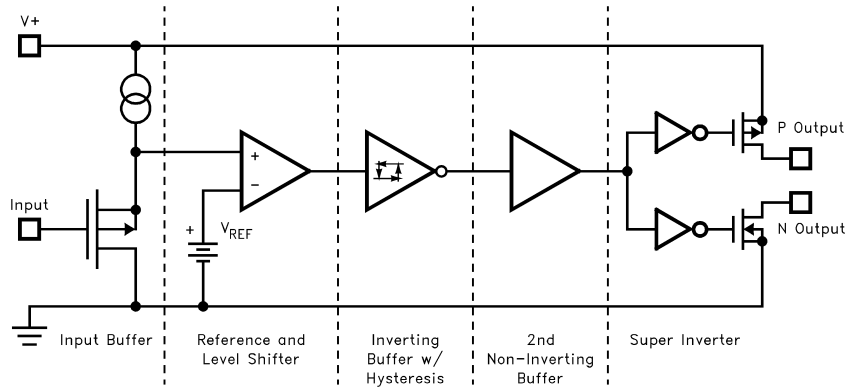

EL7104C, EL7114C

High Speed, Single Channel, Power MOSFET Drivers

EL7104C, EL7114C

Typical Performance Curves

Max Power/Derating Curves

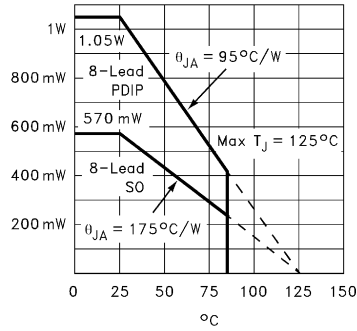

Switch Threshold vs Supply Voltage

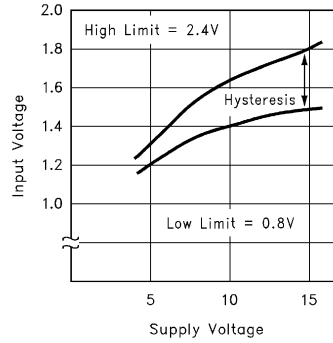

Input Current vs Voltage

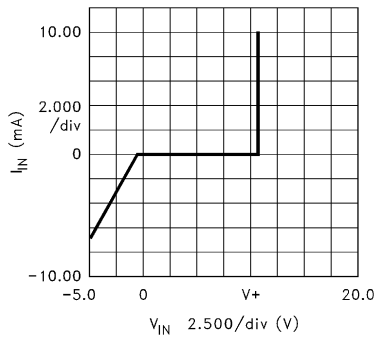

Peak Drive vs Supply Voltage

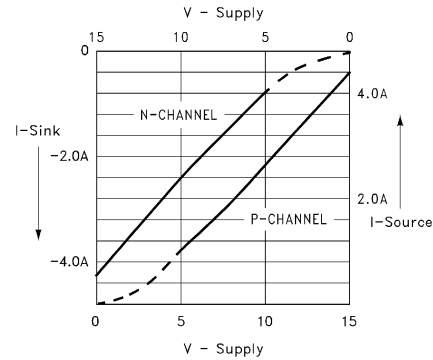

Quiescent Supply Current

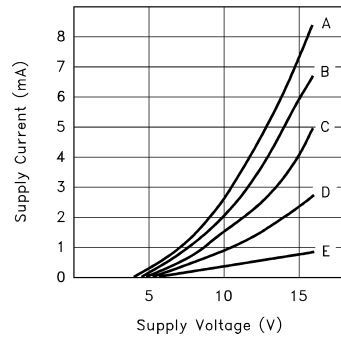

CASE:

Device	Input Level	Curve
EL7104	GND	A
EL7104	V+	C
EL7114	GND	E
EL7114	V+	C

"ON" Resistance vs Supply Voltage

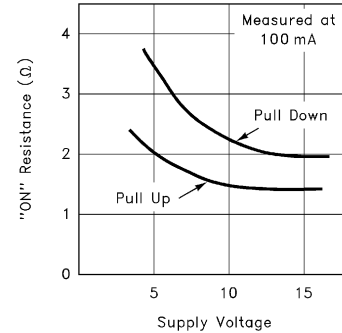

EL7104C, EL7114C

High Speed, Single Channel, Power MOSFET Drivers

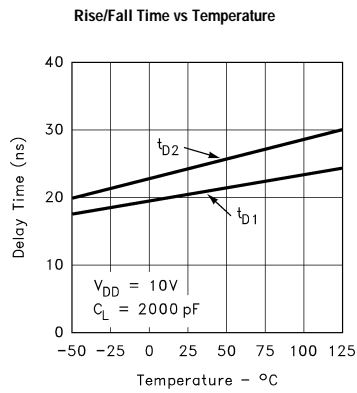
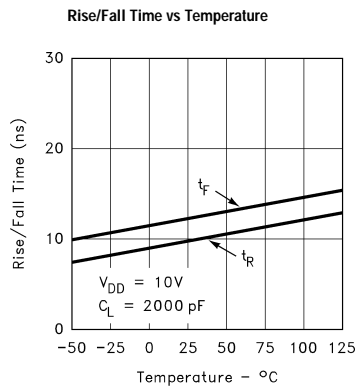
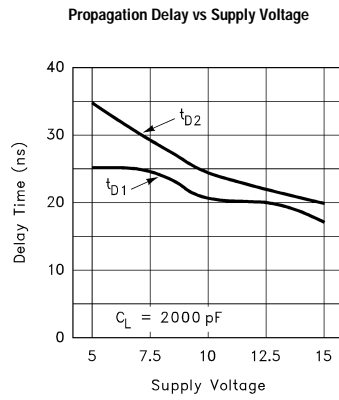
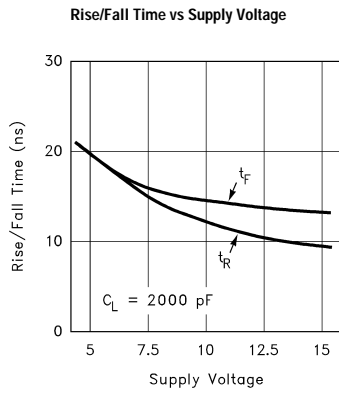
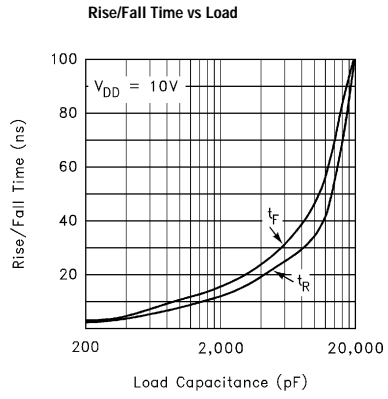
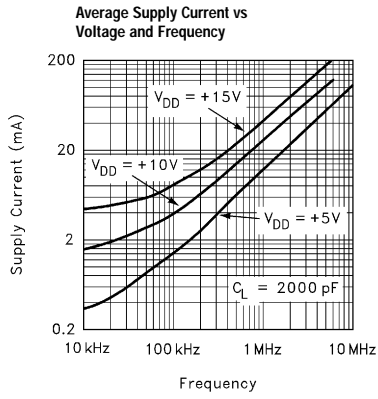

EL7104C, EL7114C*High Speed, Single Channel, Power MOSFET Drivers***General Disclaimer**

Specifications contained in this data sheet are in effect as of the publication date shown. Elantec, Inc. reserves the right to make changes in the circuitry or specifications contained herein at any time without notice. Elantec, Inc. assumes no responsibility for the use of any circuits described herein and makes no representations that they are free from patent infringement.

élantec

HIGH PERFORMANCE ANALOG INTEGRATED CIRCUITS

Elantec Semiconductor, Inc.

675 Trade Zone Blvd.

Milpitas, CA 95035

Telephone: (408) 945-1323

(888) ELANTEC

Fax: (408) 945-9305

European Office: +44-118-977-6020

Japan Technical Center: +81-45-682-5820

WARNING - Life Support Policy

Elantec, Inc. products are not authorized for and should not be used within Life Support Systems without the specific written consent of Elantec, Inc. Life Support systems are equipment intended to support or sustain life and whose failure to perform when properly used in accordance with instructions provided can be reasonably expected to result in significant personal injury or death. Users contemplating application of Elantec, Inc. Products in Life Support Systems are requested to contact Elantec, Inc. factory headquarters to establish suitable terms & conditions for these applications. Elantec, Inc.'s warranty is limited to replacement of defective components and does not cover injury to persons or property or other consequential damages.