



# STPS16H100CT/CG/CFP/CR

## HIGH VOLTAGE POWER SCHOTTKY RECTIFIER

### MAIN PRODUCT CHARACTERISTICS

$I_{F(AV)}$	2 x 8 A
$V_{RRM}$	100 V
$T_j$ (max)	175 °C
$V_F$ (max)	0.64 V

### FEATURES AND BENEFITS

- NEGLIGIBLE SWITCHING LOSSES
- HIGH JUNCTION TEMPERATURE CAPABILITY
- LOW LEAKAGE CURRENT
- GOOD TRADE OFF BETWEEN LEAKAGE CURRENT AND FORWARD VOLTAGE DROP
- AVALANCHE CAPABILITY SPECIFIED

### DESCRIPTION

Dual center tap Schottky rectifier designed for high frequency miniature Switch Mode Power Supplies such as adaptators and on board DC/DC converters.

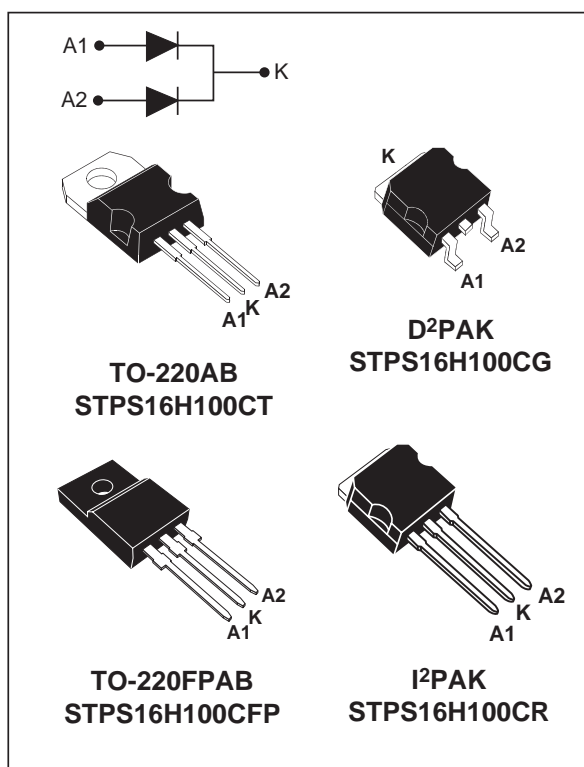

### ABSOLUTE RATINGS (limiting values, per diode)

Symbol	Parameter			Value	Unit	
$V_{RRM}$	Repetitive peak reverse voltage			100	V	
$I_{F(RMS)}$	RMS forward current			30	A	
$I_{F(AV)}$	Average forward current $\delta = 0.5$	TO-220AB D <sup>2</sup> PAK / I <sup>2</sup> PAK	$T_c = 165^\circ\text{C}$	Per diode	8	A
		TO-220FPAB	$T_c = 150^\circ\text{C}$	Per device	16	
$I_{FSM}$	Surge non repetitive forward current		$t_p = 10 \text{ ms}$ sinusoidal	200	A	
$I_{RRM}$	Repetitive peak reverse current		$t_p = 2 \mu\text{s}$ square $F = 1 \text{ kHz}$	1	A	
$I_{RSM}$	Non repetitive peak reverse current		$t_p = 100 \mu\text{s}$ square	2	A	
$P_{ARM}$	Repetitive peak avalanche power		$t_p = 1 \mu\text{s}$ $T_j = 25^\circ\text{C}$	8700	W	
$T_{stg}$	Storage temperature range			-65 to +175	°C	
$T_j$	Maximum operating junction temperature *			175	°C	
$dV/dt$	Critical rate of rise of reverse voltage			10000	V/ $\mu\text{s}$	

\* :  $\frac{dP_{tot}}{dT_j} < \frac{1}{R_{th(j-a)}}$  thermal runaway condition for a diode on its own heatsink

# STPS16H100CT/CG/CFP/CR

## THERMAL RESISTANCES

Symbol	Parameter		Value	Unit	
R <sub>th(j-c)</sub>	Junction to ambient	TO-220AB / D <sup>2</sup> PAK / I <sup>2</sup> PAK	Per diode	1.6	°C/W
		TO-220FPAB		4	
		TO-220AB / D <sup>2</sup> PAK / I <sup>2</sup> PAK	Total	1.1	°C/W
		TO-220FPAB		3.5	
R <sub>th(c)</sub>		TO-220AB / D <sup>2</sup> PAK / I <sup>2</sup> PAK	Coupling	0.6	°C/W
		TO-220FPAB		3	

When the diodes 1 and 2 are used simultaneously :  
 $\Delta T_j(\text{diode 1}) = P(\text{diode 1}) \times R_{th(j-c)}(\text{Per diode}) + P(\text{diode 2}) \times R_{th(c)}$

## STATIC ELECTRICAL CHARACTERISTICS (per diode)

Symbol	Parameter	Tests Conditions		Min.	Typ.	Max.	Unit
I <sub>R</sub> *	Reverse leakage Current	T <sub>j</sub> = 25°C	V <sub>R</sub> = V <sub>RRM</sub>			3.6	μA
		T <sub>j</sub> = 125°C			1.6	5	mA
V <sub>F</sub> **	Forward Voltage drop	T <sub>j</sub> = 25°C	I <sub>F</sub> = 8 A			0.77	V
		T <sub>j</sub> = 125°C	I <sub>F</sub> = 8 A		0.59	0.64	
		T <sub>j</sub> = 25°C	I <sub>F</sub> = 16 A			0.88	
		T <sub>j</sub> = 125°C	I <sub>F</sub> = 16 A		0.67	0.73	

Pulse test : \* t<sub>p</sub> = 5 ms, δ < 2%  
 \*\* t<sub>p</sub> = 380 μs, δ < 2%

To evaluate the conduction losses use the following equation :  
 $P = 0.55 \times I_{F(AV)} + 0.011 \times I_{F(RMS)}^2$

Fig. 1: Conduction losses versus average current.

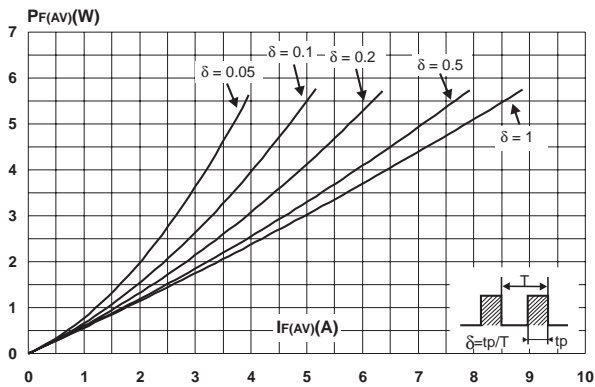
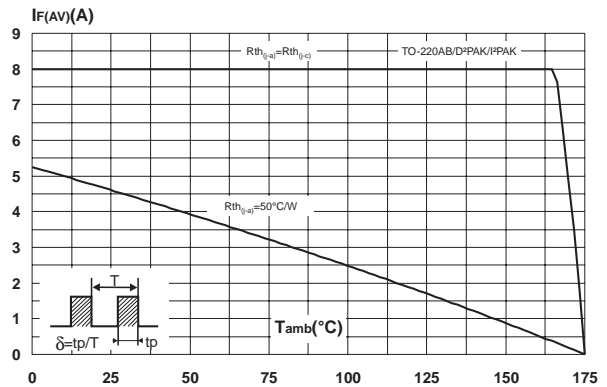
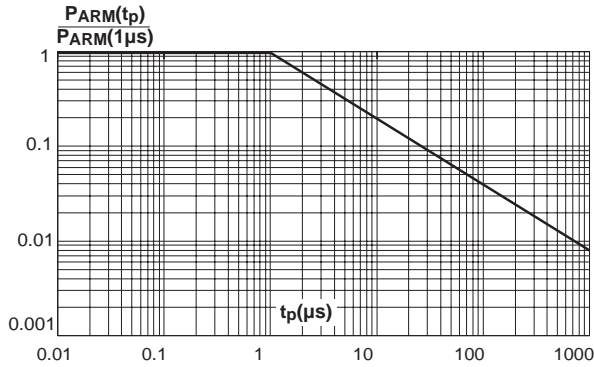

Fig. 2: Average forward current versus ambient temperature (δ=0.5).



**Fig. 3:** Normalized avalanche power derating versus pulse duration.



**Fig. 4:** Normalized avalanche power derating versus junction temperature.

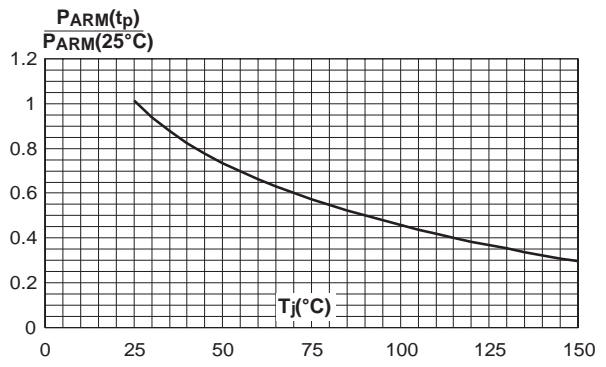

**Fig. 5-1:** Non repetitive surge peak forward current versus overload duration (maximum values) (TO-220AB, D<sup>2</sup>PAK, I<sup>2</sup>PAK).

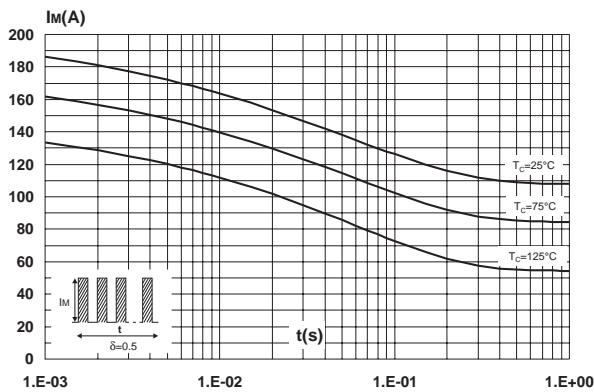

**Fig. 5-2:** Non repetitive surge peak forward current versus overload duration (maximum values) (TO-220FPAB).

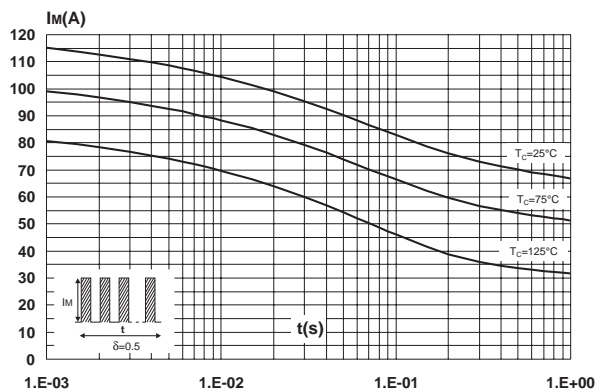

**Fig. 6-1:** Relative variation of thermal impedance junction to case versus pulse duration (TO-220AB, D<sup>2</sup>PAK & I<sup>2</sup>PAK).

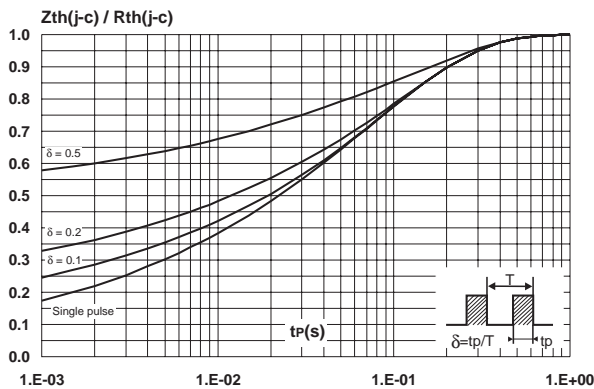

**Fig. 6-2:** Relative variation of thermal impedance junction to case versus pulse duration (TO-220FPAB).

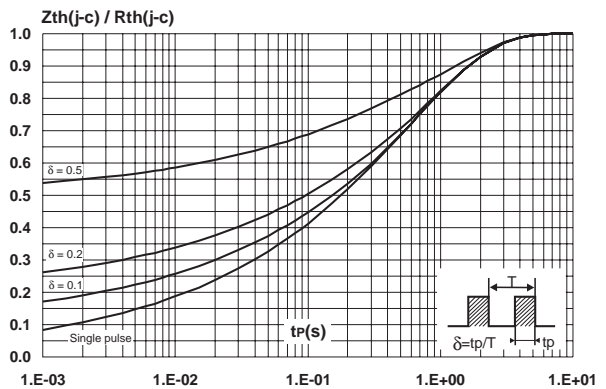

**Fig. 7:** Reverse leakage current versus reverse voltage applied (typical values).

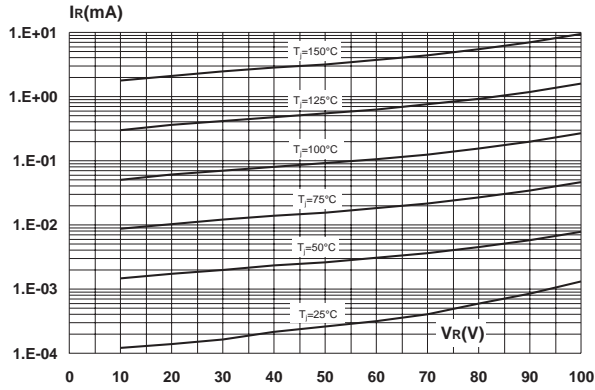

**Fig. 8:** Junction capacitance versus reverse voltage applied (typical values).

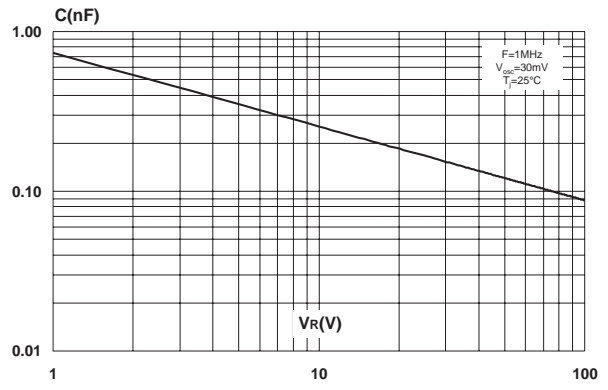

**Fig. 9:** Forward voltage drop versus forward current.

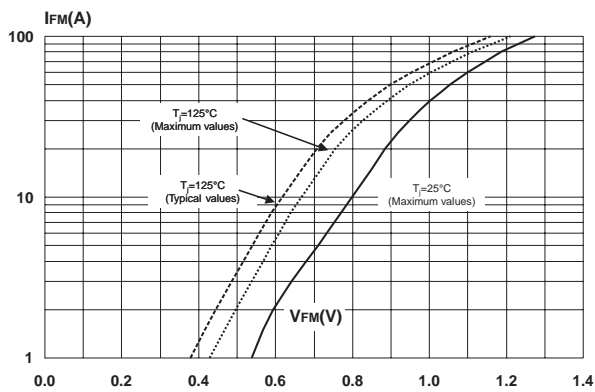

**Fig. 10:** Thermal resistance junction to ambient versus copper surface under tab (epoxy printed board FR4, Cu = 35 $\mu\text{m}$ ).

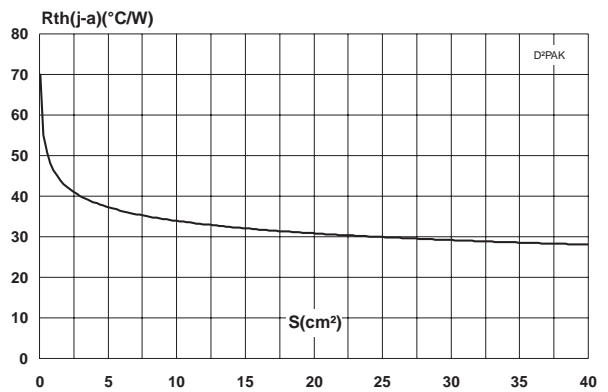

**PACKAGE MECHANICAL DATA**  
TO-220FPAB

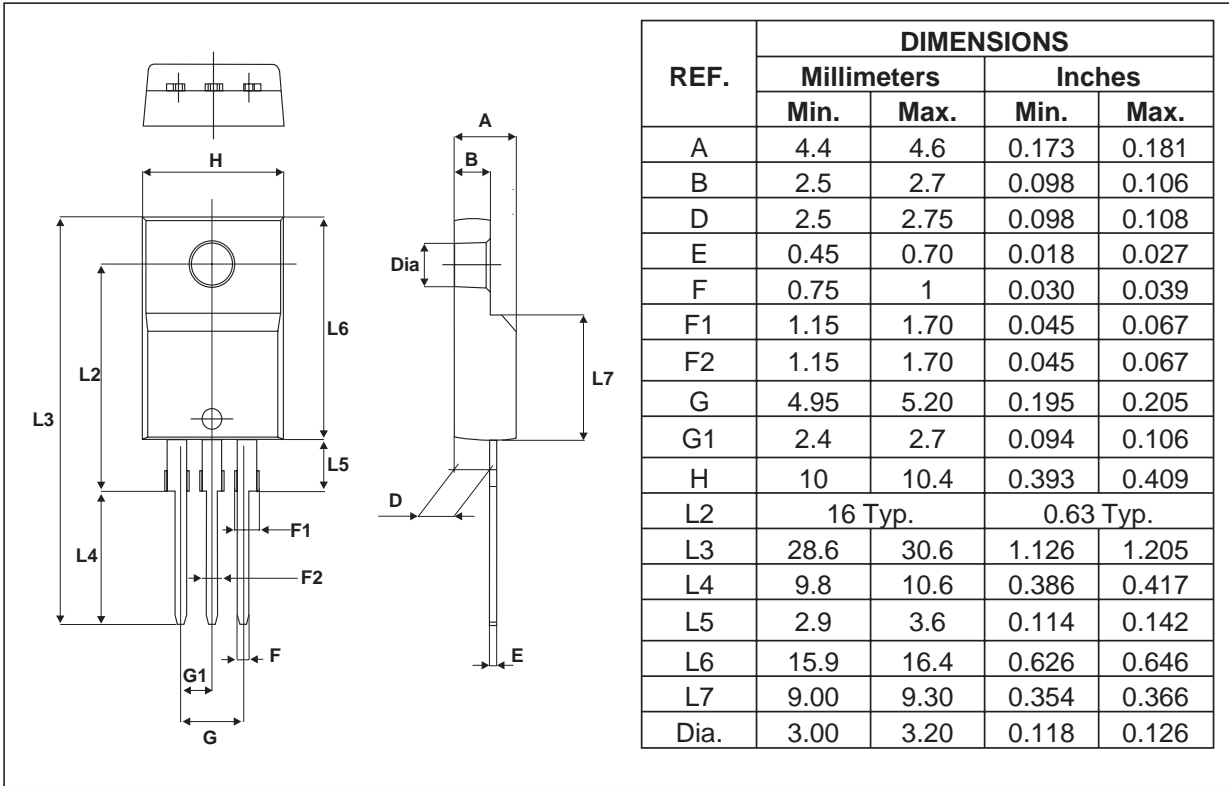

**PACKAGE MECHANICAL DATA**  
I<sup>2</sup>PAK

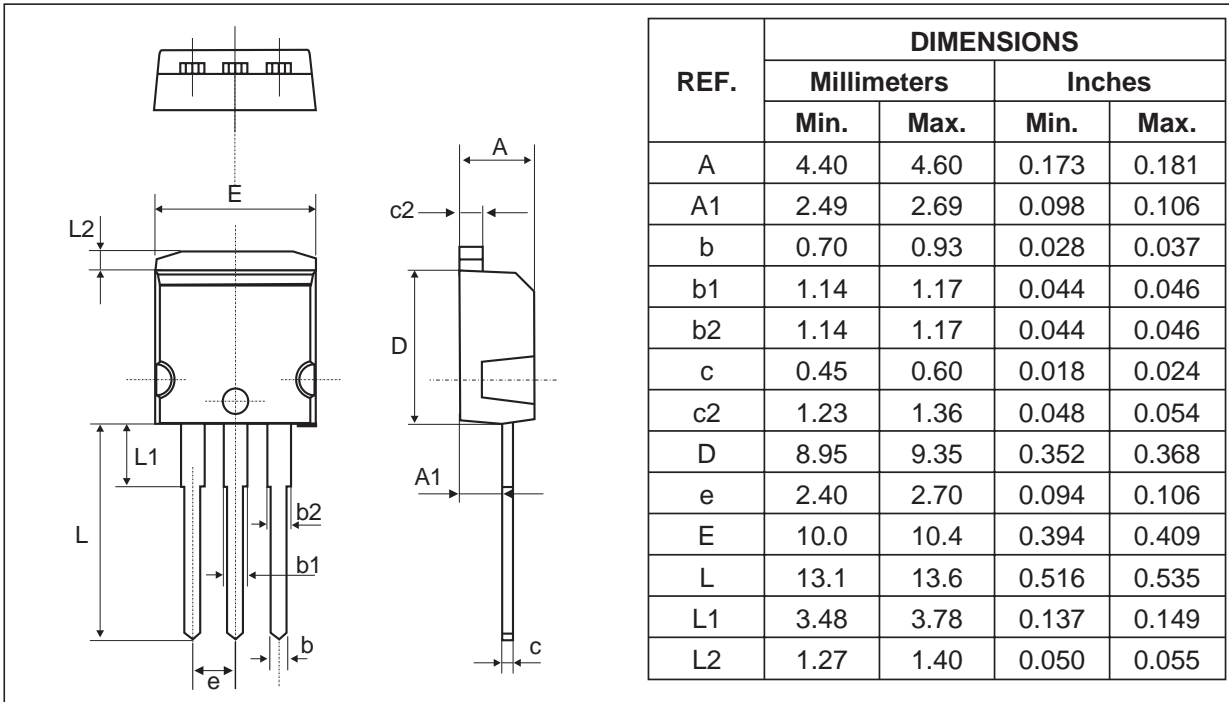

**STPS16H100CT/CG/CFP/CR**

**PACKAGE MECHANICAL DATA**  
D<sup>2</sup>PAK

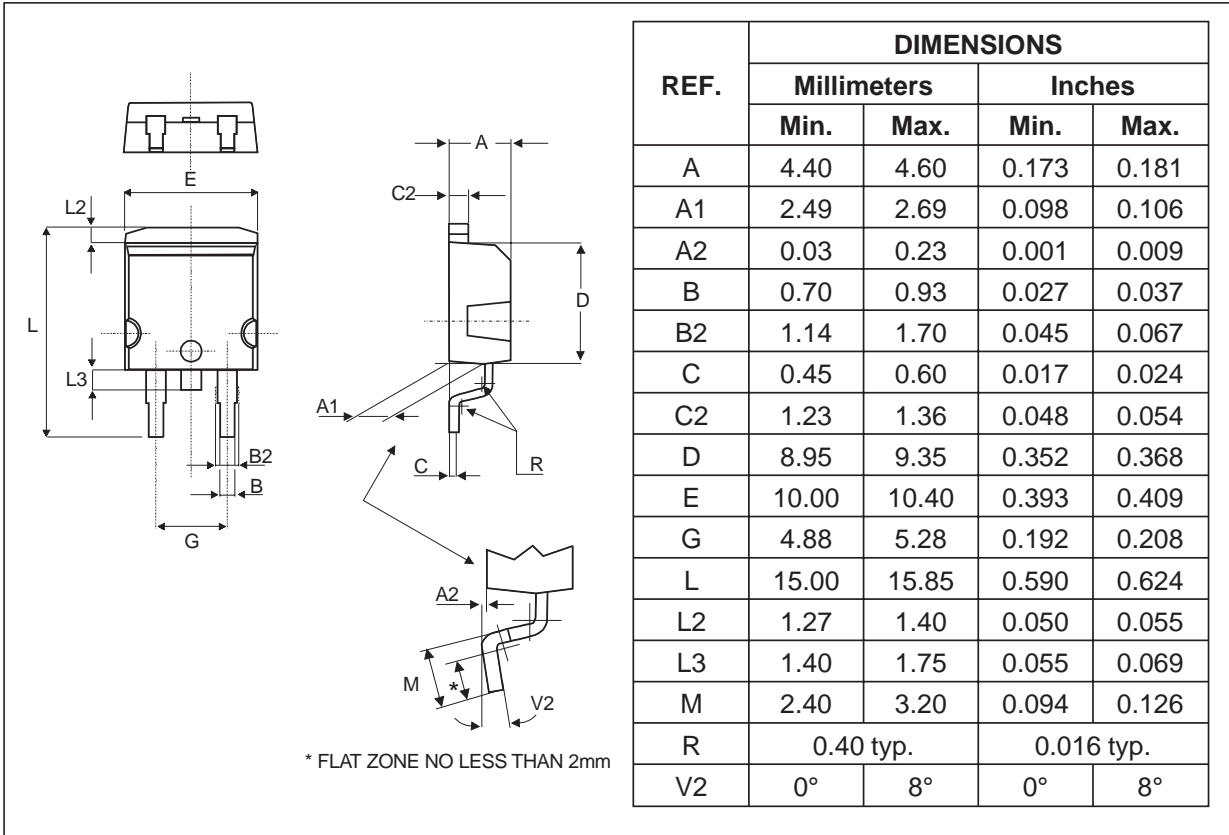

**FOOTPRINT**

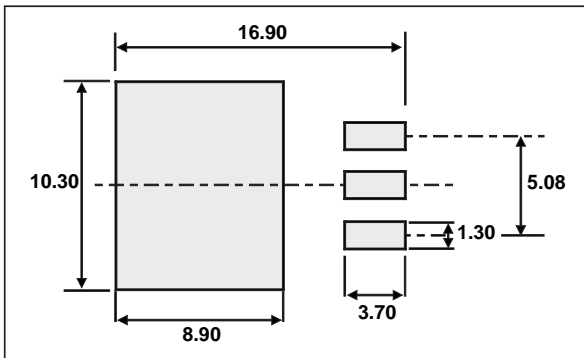

**PACKAGE MECHANICAL DATA**  
 TO-220AB

REF.	DIMENSIONS			
	Millimeters		Inches	
	Min.	Max.	Min.	Max.
A	4.40	4.60	0.173	0.181
C	1.23	1.32	0.048	0.051
D	2.40	2.72	0.094	0.107
E	0.49	0.70	0.019	0.027
F	0.61	0.88	0.024	0.034
F1	1.14	1.70	0.044	0.066
F2	1.14	1.70	0.044	0.066
G	4.95	5.15	0.194	0.202
G1	2.40	2.70	0.094	0.106
H2	10	10.40	0.393	0.409
L2	16.4 typ.		0.645 typ.	
L4	13	14	0.511	0.551
L5	2.65	2.95	0.104	0.116
L6	15.25	15.75	0.600	0.620
L7	6.20	6.60	0.244	0.259
L9	3.50	3.93	0.137	0.154
M	2.6 typ.		0.102 typ.	
Diam.	3.75	3.85	0.147	0.151

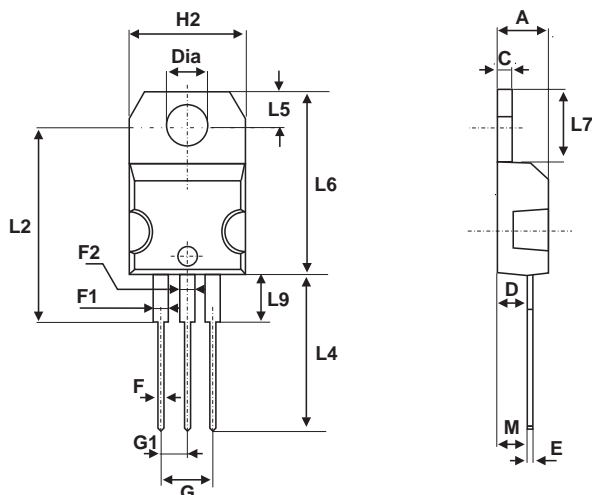

Ordering type	Marking	Package	Weight	Base qty	Delivery mode
STPS16H100CT	STPS16H100CT	TO-220AB	2.20 g	50	Tube
STPS16H100CFP	STPS16H100CFP	TO-220FPAB	2.0 g	50	Tube
STPS16H100CG	STPS16H100CG	D <sup>2</sup> PAK	1.48 g	50	Tube
STPS16H100CG-TR	STPS16H100CG	D <sup>2</sup> PAK	1.48 g	1000	Tape & reel
STPS16H100CR	STPS16H100CR	I <sup>2</sup> PAK	1.9 g	50	Tube

**■ EPOXY MEETS UL94,V0**

Information furnished is believed to be accurate and reliable. However, STMicroelectronics assumes no responsibility for the consequences of use of such information nor for any infringement of patents or other rights of third parties which may result from its use. No license is granted by implication or otherwise under any patent or patent rights of STMicroelectronics. Specifications mentioned in this publication are subject to change without notice. This publication supersedes and replaces all information previously supplied. STMicroelectronics products are not authorized for use as critical components in life support devices or systems without express written approval of STMicroelectronics.

The ST logo is a registered trademark of STMicroelectronics

© 2003 STMicroelectronics - Printed in Italy - All rights reserved.

STMicroelectronics GROUP OF COMPANIES

Australia - Brazil - Canada - China - Finland - France - Germany  
 Hong Kong - India - Israel - Italy - Japan - Malaysia - Malta - Morocco - Singapore  
 Spain - Sweden - Switzerland - United Kingdom - United States.

<http://www.st.com>

