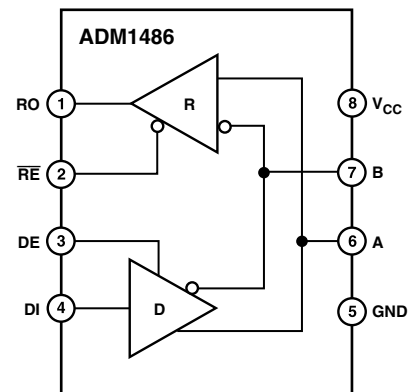

**FEATURES**

**Meets and Exceeds EIA RS-485 and EIA RS-422 Standards**  
**30 Mbps Data Rate**  
**Recommended for PROFIBUS Applications**  
**2.1 V Minimum Differential Output with 54  $\Omega$  Termination**  
**Low Power 0.8 mA  $I_{CC}$**   
**Thermal Shutdown and Short Circuit Protection**  
**0.5 ns Skew Driver and Receiver**  
**Driver Propagation Delay: 11 ns**  
**Receiver Propagation Delay: 12 ns**  
**High Impedance Outputs with Drivers Disabled or Power Off**  
**Superior Upgrade for SN65ALS1176**  
**Available in Standard 8-Lead SOIC Package**

**APPLICATIONS**

**Industrial Field Equipment**

**FUNCTIONAL BLOCK DIAGRAM**

**GENERAL DESCRIPTION**

The ADM1486 is a differential line transceiver suitable for high speed bidirectional data communication on multipoint bus transmission lines. It is designed for balanced data transmission, complies with EIA Standards RS-485 and RS-422, and is recommended for PROFIBUS applications. The part contains a differential line driver and a differential line receiver. Both the driver and the receiver may be enabled independently. When disabled or with power off, the driver outputs are high impedance.

The ADM1486 operates from a single 5 V power supply. Excessive power dissipation caused by bus contention or by output shorting is prevented by short circuit protection and thermal circuitry. Short circuit protection circuits limit the maximum output current to  $\pm 200$  mA during fault conditions. A thermal shutdown circuit senses if the die temperature rises above 150°C and forces the driver outputs into a high impedance state under this condition.

Up to 50 transceivers may be connected simultaneously on a bus, but only one driver should be enabled at any time. It is therefore important that the remaining disabled drivers do not load the bus.

To ensure this, the ADM1486 driver features high output impedance when disabled and when powered down.

This minimizes the loading effect when the transceiver is not being used. The high impedance driver output is maintained over the entire common-mode voltage range from -7 V to +12 V.

The receiver contains a fail-safe feature that results in a logic high output state if the inputs are unconnected (floating).

The ADM1486 is fabricated on BiCMOS, an advanced mixed technology process combining low power CMOS with fast switching bipolar technology. All inputs and outputs contain protection against ESD; all driver outputs feature high source and sink current capability. An epitaxial layer is used to guard against latch-up.

The ADM1486 features extremely fast and closely matched switching, enable, and disable times. Minimal driver propagation delays permit transmission at data rates up to 30 Mbps while low skew minimizes EMI interference.

The part is fully specified over the commercial and industrial temperature range and is available in an 8-lead SOIC package.

REV. 0

Information furnished by Analog Devices is believed to be accurate and reliable. However, no responsibility is assumed by Analog Devices for its use, nor for any infringements of patents or other rights of third parties that may result from its use. No license is granted by implication or otherwise under any patent or patent rights of Analog Devices.

# ADM1486—SPECIFICATIONS (V<sub>CC</sub> = 5 V ± 5%. All specifications T<sub>MIN</sub> to T<sub>MAX</sub>, unless otherwise noted.)

Parameter	Min	Typ	Max	Unit	Test Conditions/Comments
<b>DRIVER</b>					
Differential Output Voltage, V <sub>OD</sub>			5.0	V	R = Infinity, Test Circuit 1
	2.1		5.0	V	V <sub>CC</sub> = 5 V, R = 50 Ω (RS-422), Test Circuit 1
	2.1		5.0	V	R = 27 Ω (RS-485), Test Circuit 1
V <sub>OD3</sub>	2.1		5.0	V	V <sub>TST</sub> = -7 V to +12 V, Test Circuit 2
Δ V <sub>OD</sub>   for Complementary Output States			0.2	V	R = 27 Ω or 50 Ω, Test Circuit 1
Common-Mode Output Voltage V <sub>OC</sub>			3	V	R = 27 Ω or 50 Ω, Test Circuit 1
Δ V <sub>OC</sub>   for Complementary Output States			0.2	V	R = 27 Ω or 50 Ω
Output Short Circuit Current (V <sub>OUT</sub> = High)	60		200	mA	-7 V ≤ V <sub>O</sub> ≤ +12 V
Output Short Circuit Current (V <sub>OUT</sub> = Low)	60		200	mA	-7 V ≤ V <sub>O</sub> ≤ +12 V
CMOS Input Logic Threshold Low, V <sub>INL</sub>			0.8	V	
CMOS Input Logic Threshold High, V <sub>INH</sub>	2.0			V	
Logic Input Current (DE, DI)			±1.0	μA	
<b>RECEIVER</b>					
Differential Input Threshold Voltage, V <sub>TH</sub>	-0.2		+0.2	V	-7 V ≤ V <sub>CM</sub> ≤ +12 V
Input Voltage Hysteresis, ΔV <sub>TH</sub>		70		mV	V <sub>CM</sub> = 0 V
Input Resistance	20	30		kΩ	-7 V ≤ V <sub>CM</sub> ≤ +12 V
Input Current (A, B)			0.6	mA	V <sub>IN</sub> = +12 V
			-0.35	mA	V <sub>IN</sub> = -7 V
Logic Enable Input Current ( $\overline{RE}$ )			±1	μA	
CMOS Output Voltage Low, V <sub>OL</sub>			0.4	V	I <sub>OUT</sub> = +4.0 mA
CMOS Output Voltage High, V <sub>OH</sub>	4.0			V	I <sub>OUT</sub> = -4.0 mA
Short Circuit Output Current	7		85	mA	V <sub>OUT</sub> = GND or V <sub>CC</sub>
Three-State Output Leakage Current			±1.0	μA	0.4 V ≤ V <sub>OUT</sub> ≤ 2.4 V
<b>POWER SUPPLY CURRENT</b>					
I <sub>CC</sub> (Outputs Enabled)		1.2	2	mA	Outputs Unloaded, Digital Inputs = GND or V <sub>CC</sub>
I <sub>CC</sub> (Outputs Disabled)		0.8	1.5	mA	Outputs Unloaded, Digital Inputs = GND or V <sub>CC</sub>

Specifications subject to change without notice.

## TIMING SPECIFICATIONS (V<sub>CC</sub> = 5 V ± 5%. All specifications T<sub>MIN</sub> to T<sub>MAX</sub>, unless otherwise noted.)

Parameter	Min	Typ	Max	Unit	Test Conditions/Comments
<b>DRIVER</b>					
Propagation Delay Input to Output t <sub>PLH</sub> , t <sub>PHL</sub>	4	11	17	ns	R <sub>L</sub> Diff = 54 Ω, C <sub>L1</sub> = C <sub>L2</sub> = 100 pF, Test Circuit 3
		11	13	ns	R <sub>L</sub> Diff = 54 Ω, C <sub>L1</sub> = C <sub>L2</sub> = 100 pF @ T <sub>A</sub> = 25°C
Driver O/P to $\overline{O/P}$ t <sub>SKEW</sub>		0.5	2	ns	R <sub>L</sub> Diff = 54 Ω, C <sub>L1</sub> = C <sub>L2</sub> = 100 pF, Test Circuit 3*
Driver Rise/Fall Time t <sub>R</sub> , t <sub>F</sub>		8	15	ns	R <sub>L</sub> Diff = 54 Ω, C <sub>L1</sub> = C <sub>L2</sub> = 100 pF, Test Circuit 3
Driver Enable to Output Valid t <sub>ZH</sub> , t <sub>ZL</sub>		9	15	ns	R <sub>L</sub> = 110 Ω, C <sub>L</sub> = 50 pF, Test Circuit 4
Driver Disable Timing t <sub>HZ</sub> , t <sub>LZ</sub>		9	15	ns	R <sub>L</sub> = 110 Ω, C <sub>L</sub> = 50 pF, Test Circuit 4
Matched Enable Switching					
t <sub>AZH</sub> - t <sub>BZL</sub>  ,  t <sub>BZH</sub> - t <sub>AZL</sub>		1	3	ns	R <sub>L</sub> = 110 Ω, C <sub>L</sub> = 50 pF, Test Circuit 4
Matched Disable Switching					
t <sub>AHZ</sub> - t <sub>BLZ</sub>  ,  t <sub>BHZ</sub> - t <sub>ALZ</sub>		2	5	ns	R <sub>L</sub> = 110 Ω, C <sub>L</sub> = 50 pF, Test Circuit 4
<b>RECEIVER</b>					
Propagation Delay Input to Output t <sub>PLH</sub> , t <sub>PHL</sub>	6	12	20	ns	C <sub>L</sub> = 15 pF, Test Circuit 5
Skew  t <sub>PLH</sub> - t <sub>PHL</sub>		0.4	2	ns	C <sub>L</sub> = 15 pF*, Test Circuit 5
Receiver Enable t <sub>ZH</sub> , t <sub>ZL</sub>		7	13	ns	C <sub>L</sub> = 15 pF, R <sub>L</sub> = 1 kΩ, Test Circuit 6
Receiver Disable t <sub>HZ</sub> , t <sub>LZ</sub>		7	13	ns	C <sub>L</sub> = 15 pF, R <sub>L</sub> = 1 kΩ, Test Circuit 6

\*Guaranteed by characterization.

Specifications subject to change without notice.

## ABSOLUTE MAXIMUM RATINGS\*

(T<sub>A</sub> = 25°C, unless otherwise noted.)

V <sub>CC</sub> .....	7 V
<b>Inputs</b>	
Driver Input (DI) .....	-0.3 V to V <sub>CC</sub> + 0.3 V
Control Inputs (DE, $\overline{RE}$ ) .....	-0.3 V to V <sub>CC</sub> + 0.3 V
Receiver Inputs (A, B) .....	-9 V to +14 V
<b>Outputs</b>	
Driver Outputs .....	-9 V to +14 V
Receiver Output .....	-0.5 V to V <sub>CC</sub> + 0.5 V
Power Dissipation 8-Lead SOIC .....	450 mW
θ <sub>JA</sub> , Thermal Impedance .....	170°C/W

## Operating Temperature Range

Industrial (A Version) .....	-40°C to +85°C
Storage Temperature Range .....	-65°C to +150°C
Lead Temperature (Soldering, 10 sec) .....	300°C
Vapor Phase (60 sec) .....	215°C
Infrared (15 sec) .....	220°C

\*Stresses above those listed under Absolute Maximum Ratings may cause permanent damage to the device. This is a stress rating only; functional operation of the device at these or any other conditions above those listed in the operational sections of this specification is not implied. Exposure to absolute maximum ratings for extended periods of time may affect device reliability.

## ORDERING GUIDE

Model	Temperature Range	Package Description	Package Option
ADM1486AR	-40°C to +85°C	8-Lead Narrow Body (SOIC)	RN-8

## CAUTION

ESD (electrostatic discharge) sensitive device. Electrostatic charges as high as 4000 V readily accumulate on the human body and test equipment and can discharge without detection. Although the ADM1486 features proprietary ESD protection circuitry, permanent damage may occur on devices subjected to high energy electrostatic discharges. Therefore, proper ESD precautions are recommended to avoid performance degradation or loss of functionality.



# ADM1486

## PIN CONFIGURATION

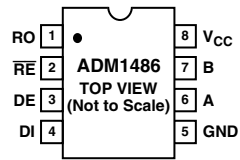

## PIN FUNCTION DESCRIPTION

Pin	Mnemonic	Function
1	RO	Receiver Output. When enabled, if $A > B$ by 200 mV, RO = High. If $A < B$ by 200 mV, RO = Low.
2	$\overline{RE}$	Receiver Output Enable. A low level enables the receiver output, RO. A high level places it in a high impedance state.
3	DE	Driver Output Enable. A high level enables the driver differential outputs, A and B. A low level places it in a high impedance state.
4	DI	Driver Input. When the driver is enabled, a logic Low on DI forces A low and B high while a logic High on DI forces A high and B low.
5	GND	Ground Connection, 0 V
6	A	Noninverting Receiver Input A/Driver Output A
7	B	Inverting Receiver Input B/Driver Output B
8	V <sub>CC</sub>	Power Supply, 5 V $\pm$ 5%

Table I. Transmitting

Inputs		Outputs	
DE	DI	B	A
1	1	0	1
1	0	1	0
0	X	Z	Z

Table II. Receiving

$\overline{RE}$	Inputs A-B	Output RO
0	$\geq +0.2$ V	1
0	$\leq -0.2$ V	0
0	Inputs Open	1
1	X	Z

## Test Circuits

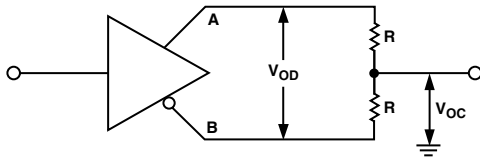

Test Circuit 1. Driver Voltage Measurement

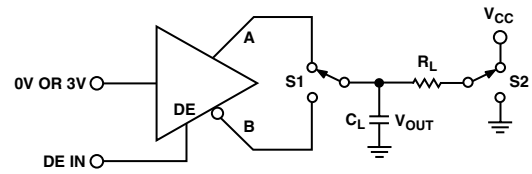

Test Circuit 4. Driver Enable/Disable

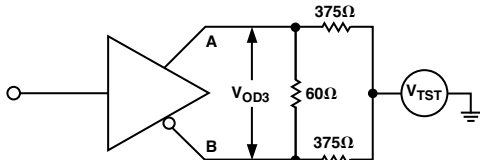

Test Circuit 2. Driver Voltage Measurement

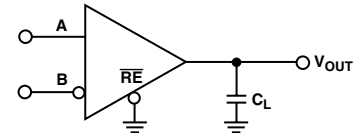

Test Circuit 5. Receiver Propagation Delay

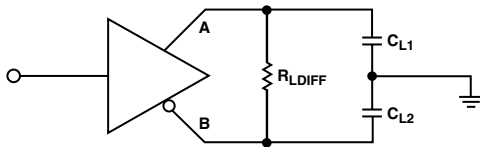

Test Circuit 3. Driver Propagation Delay

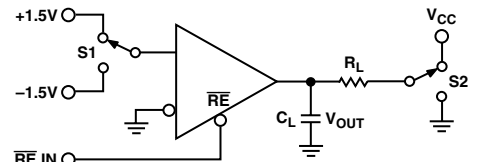

Test Circuit 6. Receiver Enable/Disable

## Switching Characteristics

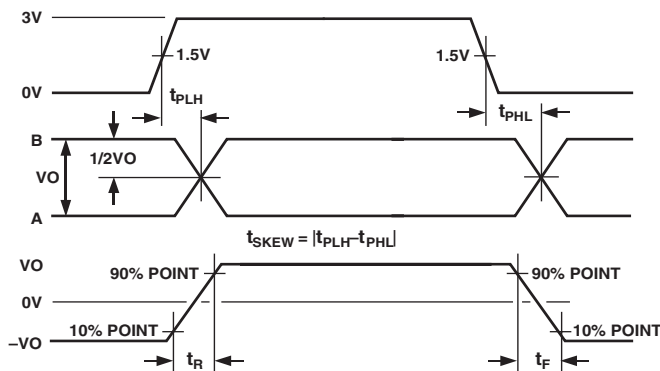

Figure 1. Driver Propagation Delay, Rise/Fall Timing

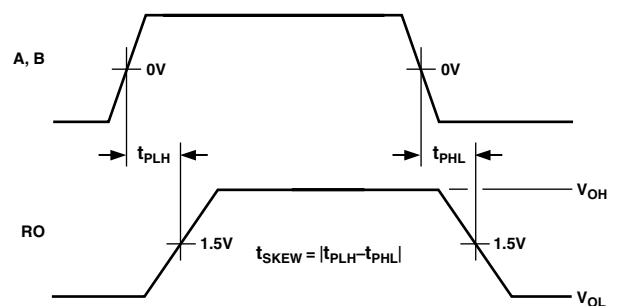

Figure 3. Receiver Propagation Delay

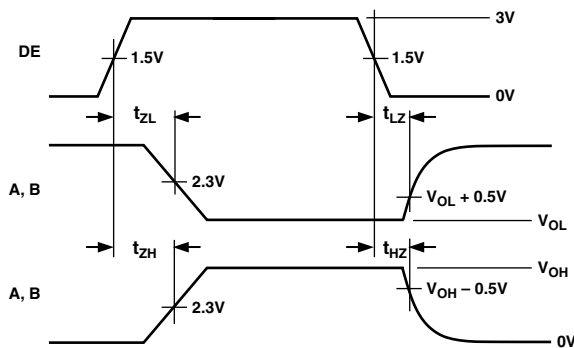

Figure 2. Driver Enable/Disable Timing

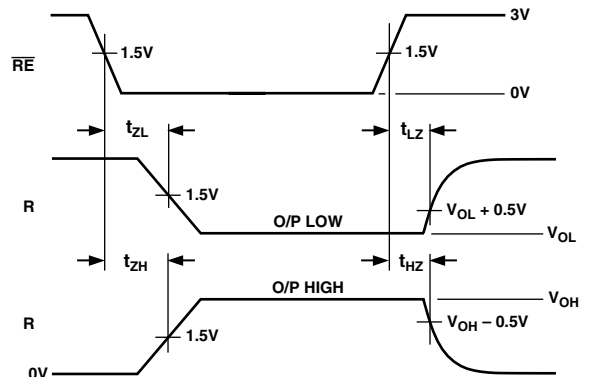
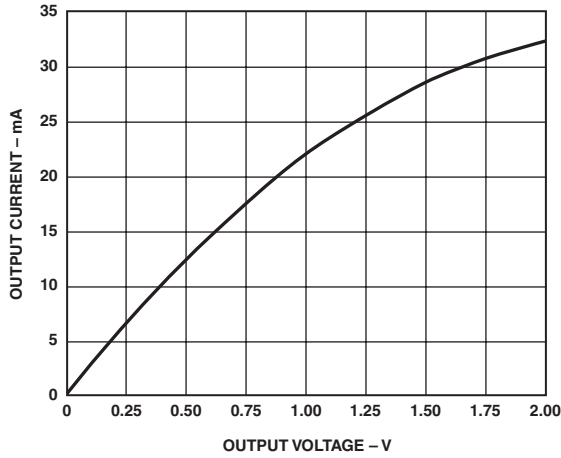
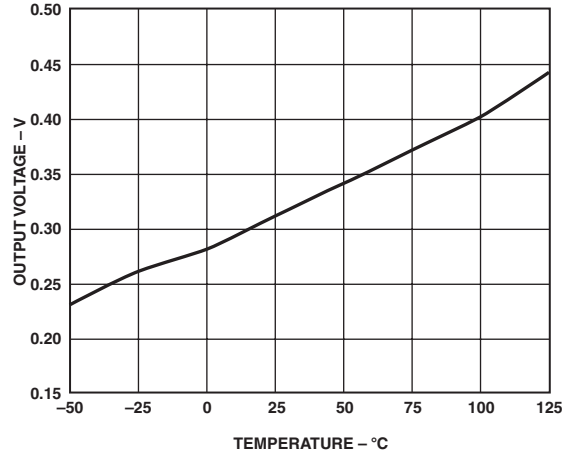

Figure 4. Receiver Enable/Disable Timing

# ADM1486—Typical Performance Characteristics



TPC 1. Output Current vs. Receiver Output Low Voltage



TPC 4. Receiver Output Low Voltage vs. Temperature  $I = 8 \text{ mA}$

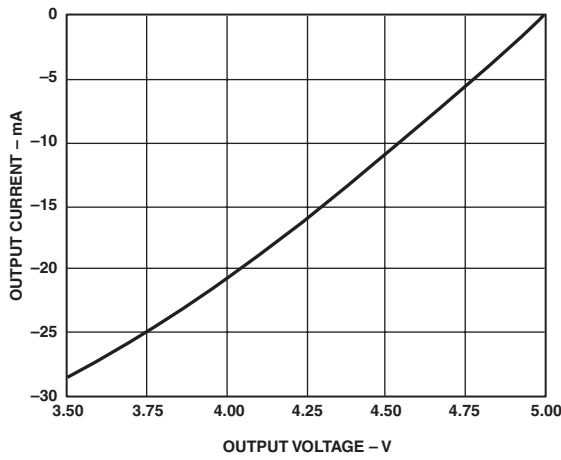

TPC 2. Output Current vs. Receiver Output High Voltage

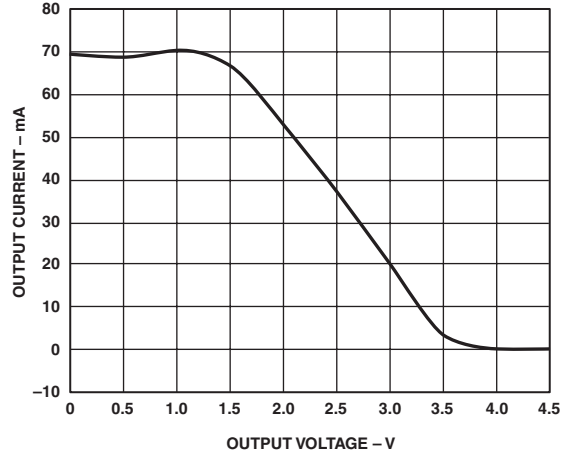

TPC 5. Output Current vs. Driver Differential Output Voltage

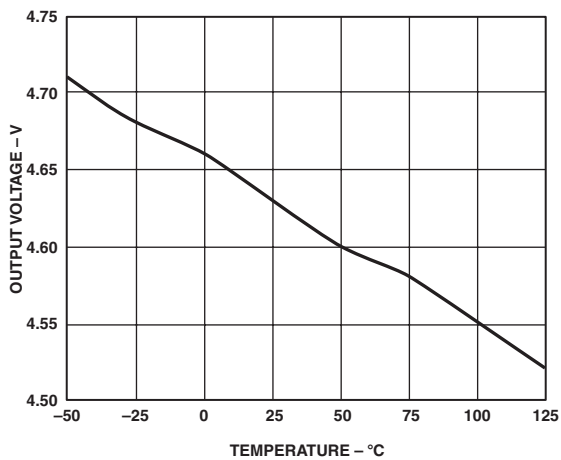

TPC 3. Receiver Output High Voltage vs. Temperature  $I = 8 \text{ mA}$

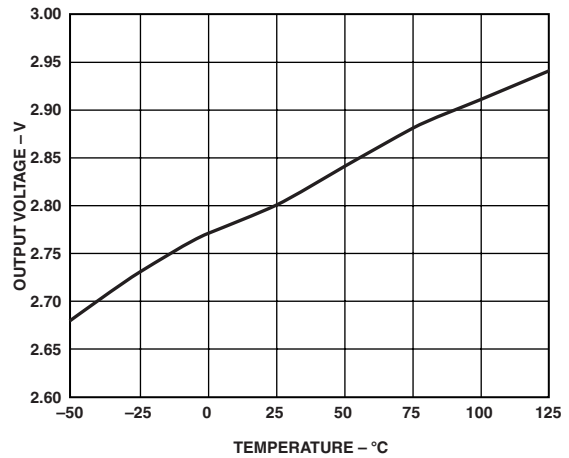

TPC 6. Driver Differential Output Voltage vs. Temperature,  $R_{L\text{Diff}} = 53.6 \Omega$

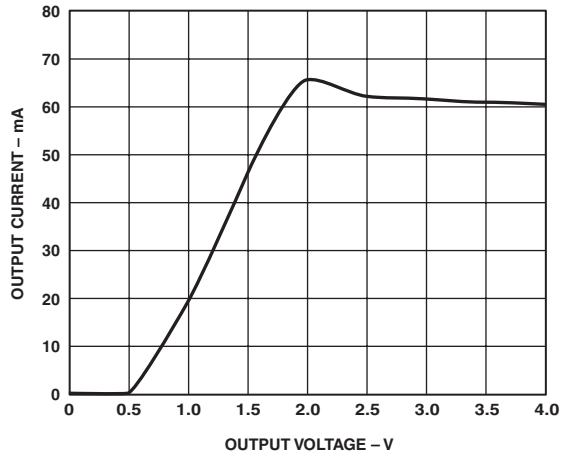

TPC 7. Output Current vs. Driver Output Low Voltage

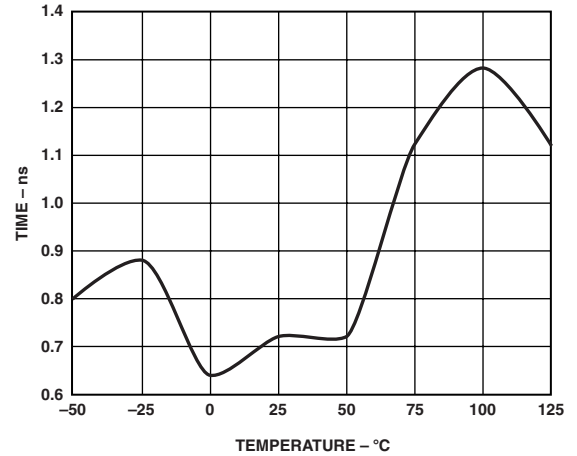

TPC 10. Receiver Skew vs. Temperature

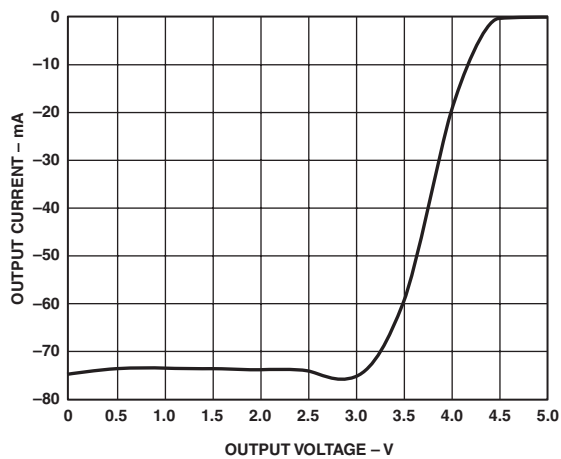

TPC 8. Output Current vs. Driver Output High Voltage

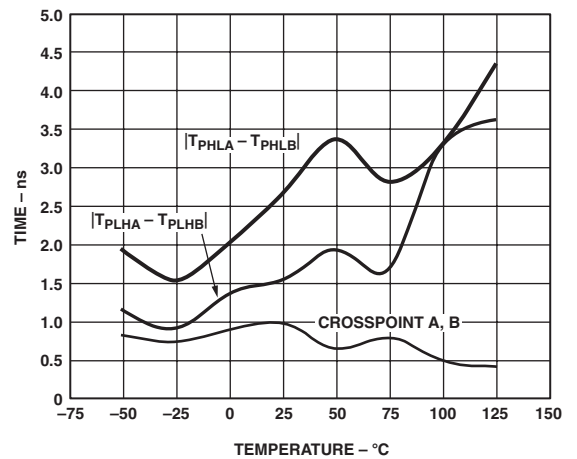

TPC 11. Driver Skew vs. Temperature

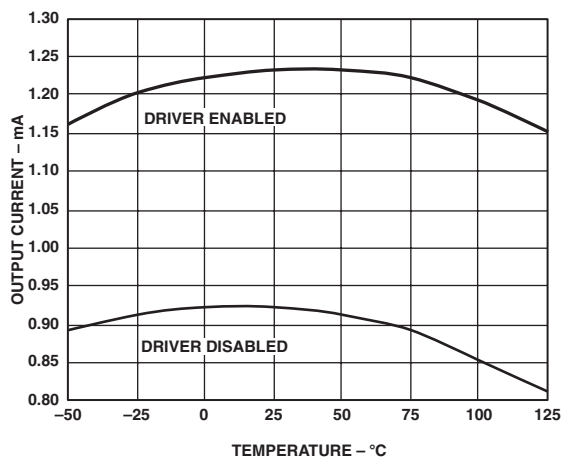

TPC 9. Supply Current vs. Temperature

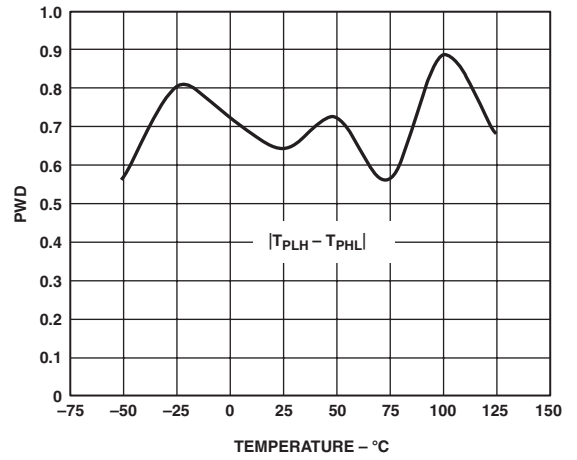

TPC 12. Tx Pulswidth Distortion

# ADM1486

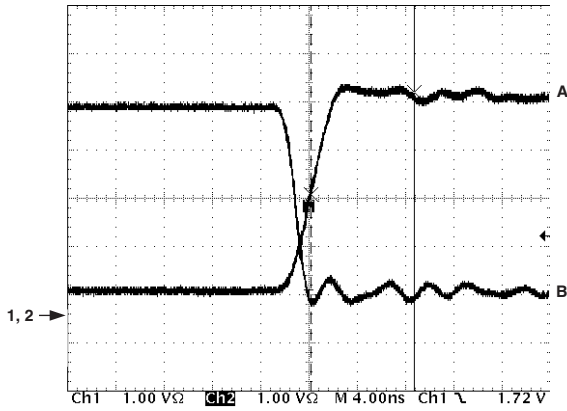

TPC 13. Unloaded Driver Differential Outputs

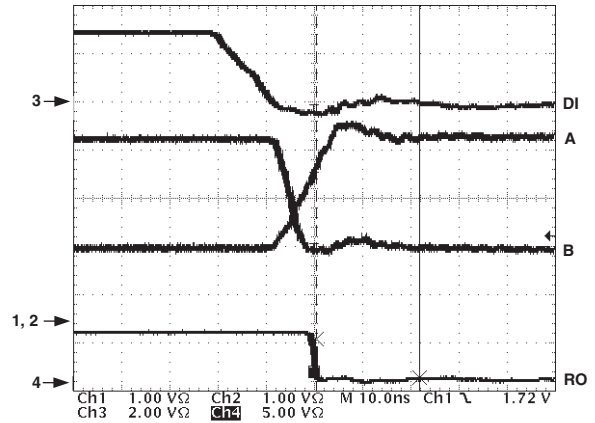

TPC 16. Driver/Receiver Propagation Delays High to Low ( $R_{LDiff} = 54 \Omega$ ,  $C_{L1} = C_{L2} = 100 \text{ pF}$ )

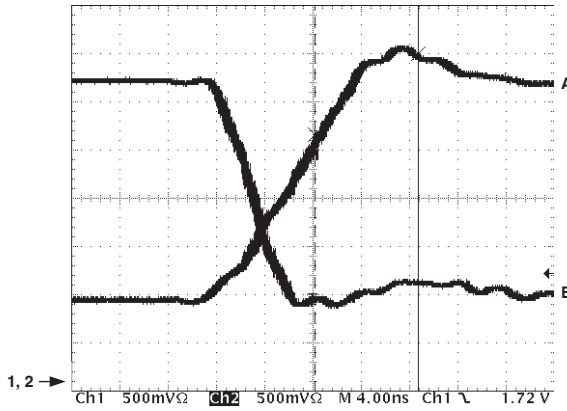

TPC 14. Loaded Driver Differential Outputs ( $R_{LDiff} = 54 \Omega$ ,  $C_{L1} = C_{L2} = 100 \text{ pF}$ )

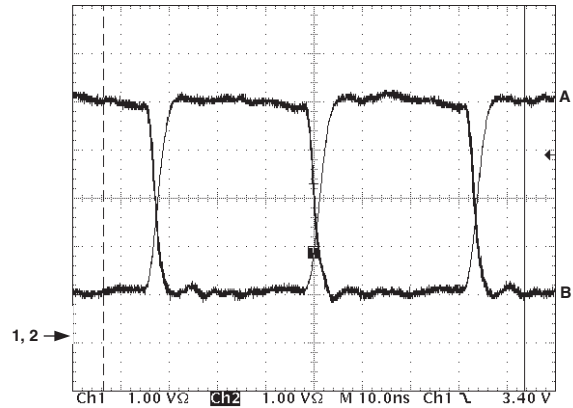

TPC 17. Unloaded Driver Outputs at 15 Mbps

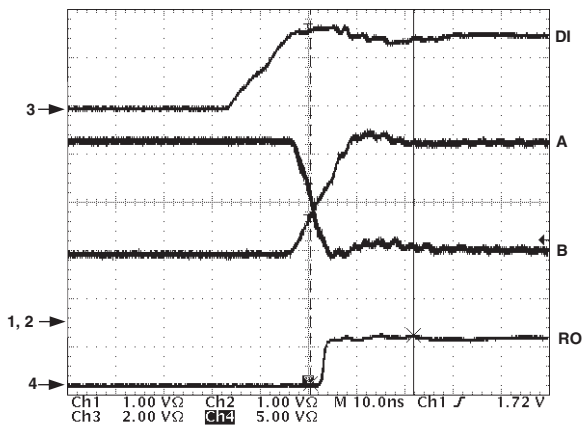

TPC 15. Driver/Receiver Propagation Delays Low to High ( $R_{LDiff} = 54 \Omega$ ,  $C_{L1} = C_{L2} = 100 \text{ pF}$ )

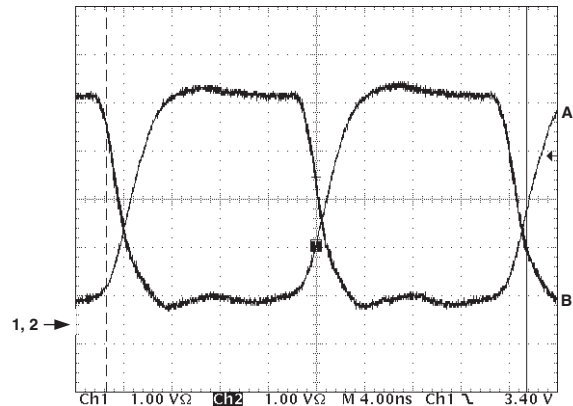

TPC 18. Unloaded Driver Outputs at 30 Mbps



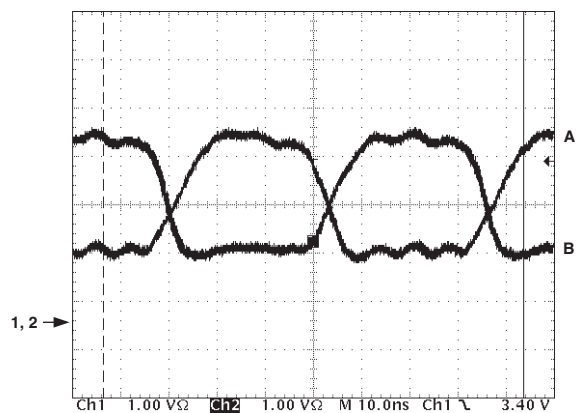

TPC 19. Loaded Driver Outputs at 15 Mbps  
 ( $R_{LDiff} = 54 \Omega$ ,  $C_{L1} = C_{L2} = 100 \text{ pF}$ )

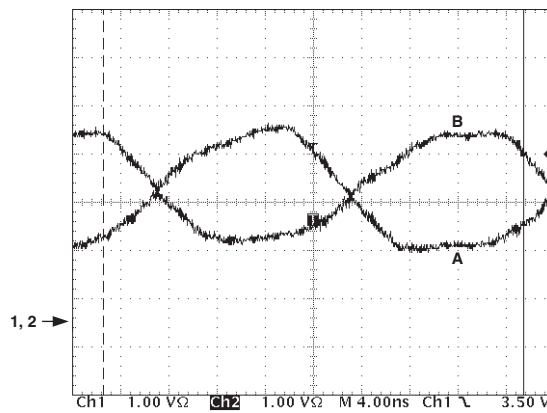

TPC 20. Loaded Driver Outputs at 30 Mbps  
 ( $R_{LDiff} = 54 \Omega$ ,  $C_{L1} = C_{L2} = 100 \text{ pF}$ )

# ADM1486

## APPLICATIONS INFORMATION

### Differential Data Transmission

Differential data transmission is used to reliably transmit data at high rates over long distances and through noisy environments. Differential transmission nullifies the effects of ground shifts and noise signals that appear as common-mode voltages on the line. There are two main standards approved by the Electronics Industries Association (EIA) that specify the electrical characteristics of transceivers used in differential data transmission.

The RS-422 standard specifies data rates up to 10 MBaud and line lengths up to 4,000 ft. A single driver can drive a transmission line with up to 10 receivers.

In order to cater to true multipoint communications, the RS-485 standard was defined. This standard meets or exceeds all the requirements of RS-422, but also allows up to 32 drivers and 32 receivers to be connected to a single bus. An extended common-mode range of  $-7\text{ V}$  to  $+12\text{ V}$  is defined. The most significant difference between RS-422 and RS-485 is that the drivers may be disabled, allowing more than one (32 in fact) to be connected to a single line. Only one driver should be enabled at a time, but the RS-485 standard contains additional specifications to guarantee device safety in the event of line contention.

### Cable and Data Rate

The transmission line of choice for RS-485 communications is a twisted pair. Twisted pair cable tends to cancel common-mode noise and also causes cancellation of the magnetic fields generated by the current flowing through each wire, thereby reducing the effective inductance of the pair.

The ADM1486 is designed for bidirectional data communications on multipoint transmission lines. A typical application showing a multipoint transmission network is illustrated in Figure 5.

An RS-485 transmission line can have as many as 32 transceivers on the bus. Only one driver can transmit at a particular time but multiple receivers may be enabled simultaneously.

As with any transmission line, it is important that reflections are minimized. This may be achieved by terminating the extreme ends of the line using resistors equal to the characteristic impedance of the line. Stub lengths of the main line should also be kept as short as possible. A properly terminated transmission line appears purely resistive to the driver.

### Thermal Shutdown

The ADM1486 contains thermal shutdown circuitry that protects the part from excessive power dissipation during fault conditions. Shorting the driver outputs to a low impedance source can result in high driver currents. The thermal sensing circuitry detects the increase in die temperature and disables the driver outputs. The thermal sensing circuitry is designed to disable the driver outputs when a die temperature of  $150^{\circ}\text{C}$  is reached. As the device cools, the drivers are re-enabled at  $140^{\circ}\text{C}$ .

### Propagation Delay

The ADM1486 features very low propagation delay, ensuring maximum baud rate operation. The driver is well balanced, ensuring distortion free transmission.

Another important specification is a measure of the skew between the complementary outputs. Excessive skew impairs the noise immunity of the system and increases the amount of electromagnetic interference (EMI).

### Receiver Open-Circuit Fail-Safe

The receiver input includes a fail-safe feature that guarantees a logic high on the receiver when the inputs are open circuit or floating.

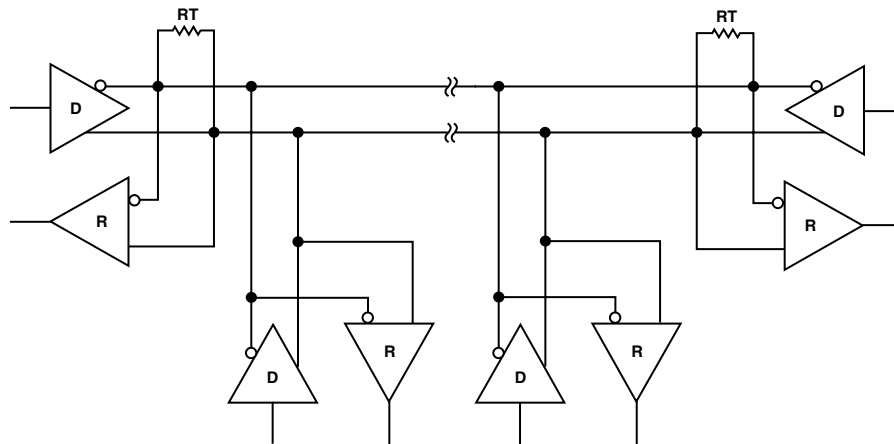

Figure 5. Typical RS-485 Network

Table III. Comparison of RS-422 and RS-485 Interface Standards

Specification	RS-422	RS-485	PROFIBUS
Transmission Type	Differential	Differential	Differential
Maximum Cable Length	4000 ft.	4000 ft.	
Minimum Driver Output Voltage	$\pm 2$ V	$\pm 1.5$ V	$\pm 2.1$ V
Driver Load Impedance	100 $\Omega$	54 $\Omega$	54 $\Omega$
Receiver Input Resistance	4 k $\Omega$ min	12 k $\Omega$ min	20 k $\Omega$ min
Receiver Input Sensitivity	$\pm 200$ mV	$\pm 200$ mV	$\pm 200$ mV
Receiver Input Voltage Range	-7 V to +7 V	-7 V to +12 V	-7 V to +12 V
No. of Drivers/Receivers Per Line	1/10	32/32	50/50

OUTLINE DIMENSIONS

8-Lead Standard Small Outline Package [SOIC]  
Narrow Body  
(RN-8)

Dimensions shown in millimeters and (inches)

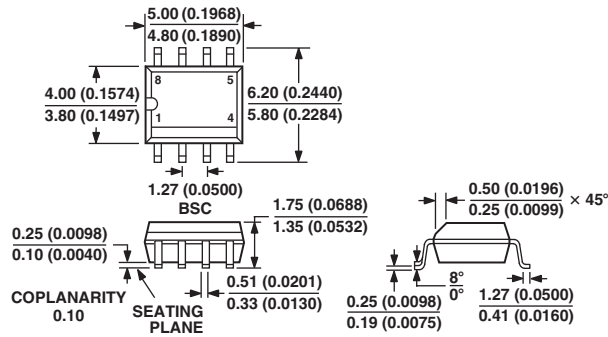

COMPLIANT TO JEDEC STANDARDS MS-012AA  
CONTROLLING DIMENSIONS ARE IN MILLIMETERS; INCH DIMENSIONS  
(IN PARENTHESES) ARE ROUNDED-OFF MILLIMETER EQUIVALENTS FOR  
REFERENCE ONLY AND ARE NOT APPROPRIATE FOR USE IN DESIGN