

## N-CHANNEL ENHANCEMENT MODE FIELD EFFECT TRANSISTOR

NEW PRODUCT

### Features

- Low Gate Threshold Voltage
- Low Input Capacitance
- Fast Switching Speed
- Low Input/Output Leakage
- High Drain-Source Voltage Rating
- Also Available in Lead Free Version

### Mechanical Data

- Case: SOT-323, Molded Plastic
- Plastic Material - UL Flammability Classification Rating 94V-0
- Moisture sensitivity: Level 1 per J-STD-020A
- Terminals: Solderable per MIL-STD-202, Method 208
- Also Available in Lead Free Plating (Matte Tin Finish). Please see Ordering Information, Note 4, on Page 3
- Terminal Connections: See Diagram
- Marking: K23 (See Page 3)

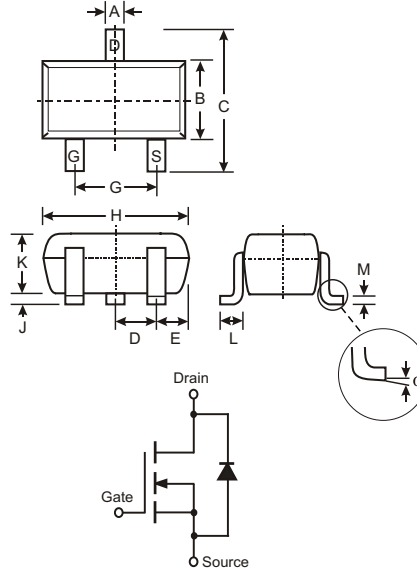

SOT-323		
Dim	Min	Max
A	0.25	0.40
B	1.15	1.35
C	2.00	2.20
D	0.65 Nominal	
E	0.30	0.40
G	1.20	1.40
H	1.80	2.20
J	0.0	0.10
K	0.90	1.00
L	0.25	0.40
M	0.10	0.18
$\alpha$	0°	8°
All Dimensions in mm		

### Maximum Ratings @ T<sub>A</sub> = 25°C unless otherwise specified

Characteristic	Symbol	Value	Units
Drain-Source Voltage	V <sub>DSS</sub>	100	V
Drain-Gate Voltage R <sub>GS</sub> ≤ 20KΩ	V <sub>DGR</sub>	100	V
Gate-Source Voltage	V <sub>GSS</sub>	±20	V
Drain Current (Note 1)	I <sub>D</sub> I <sub>DM</sub>	170 680	mA
Total Power Dissipation (Note 1)	P <sub>d</sub>	200	mW
Thermal Resistance, Junction to Ambient (Note 1)	R <sub>θJA</sub>	625	°C/W
Operating and Storage Temperature Range	T <sub>j</sub> , T <sub>STG</sub>	-55 to +150	°C

Notes: 1. Device mounted on FR-4 PC board with recommended pad layout, which can be found on our website at <http://www.diodes.com/datasheets/ap02001.pdf>.

**Electrical Characteristics** @  $T_A = 25^\circ\text{C}$  unless otherwise specified

Characteristic	Symbol	Min	Typ	Max	Unit	Test Condition
<b>OFF CHARACTERISTICS (Note 2)</b>						
Drain-Source Breakdown Voltage	$BV_{DSS}$	100	—	—	V	$V_{GS} = 0V, I_D = 250\mu A$
Zero Gate Voltage Drain Current	$I_{DSS}$	—	—	1.0 10	$\mu A$ nA	$V_{DS} = 100V, V_{GS} = 0V$ $V_{DS} = 20V, V_{GS} = 0V$
Gate-Body Leakage, Forward	$I_{GSSF}$	—	—	50	nA	$V_{GS} = 20V, V_{DS} = 0V$
<b>ON CHARACTERISTICS (Note 2)</b>						
Gate Threshold Voltage	$V_{GS(th)}$	0.8	1.4	2.0	V	$V_{DS} = V_{GS}, I_D = 1mA$
Static Drain-Source On-Resistance	$R_{DS(on)}$	—	—	6.0 10	$\Omega$	$V_{GS} = 10V, I_D = 0.17A$ $V_{GS} = 4.5V, I_D = 0.17A$
Forward Transconductance	$g_{FS}$	80	370	—	mS	$V_{DS} = 10V, I_D = 0.17A, f = 1.0KHz$
Drain-Source Diode Forward Voltage	$V_{SD}$	—	0.84	1.3	V	$V_{GS} = 0V, I_S = 0.34A$
<b>DYNAMIC CHARACTERISTICS</b>						
Input Capacitance	$C_{iss}$	—	29	60	pF	$V_{DS} = 25V, V_{GS} = 0V$ $f = 1.0MHz$
Output Capacitance	$C_{oss}$	—	10	15	pF	
Reverse Transfer Capacitance	$C_{rss}$	—	2	6	pF	
<b>SWITCHING CHARACTERISTICS</b>						
Turn-On Rise Time	$t_r$	—	—	8	ns	$V_{DD} = 30V, I_D = 0.28A,$ $R_{GEN} = 50\Omega, V_{GS} = 10V$
Turn-Off Fall Time	$t_f$	—	—	16	ns	
Turn-On Delay Time	$t_{D(ON)}$	—	—	8	ns	
Turn-Off Delay Time	$t_{D(OFF)}$	—	—	13	ns	

Notes: 2. Short duration test pulse used to minimize self-heating effect.

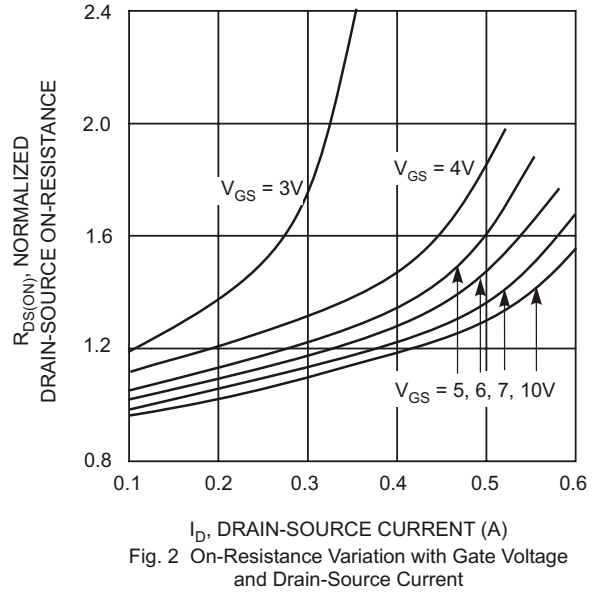
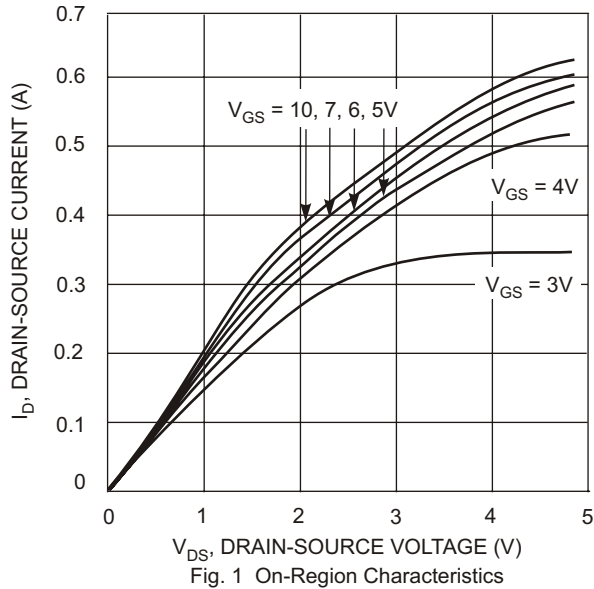

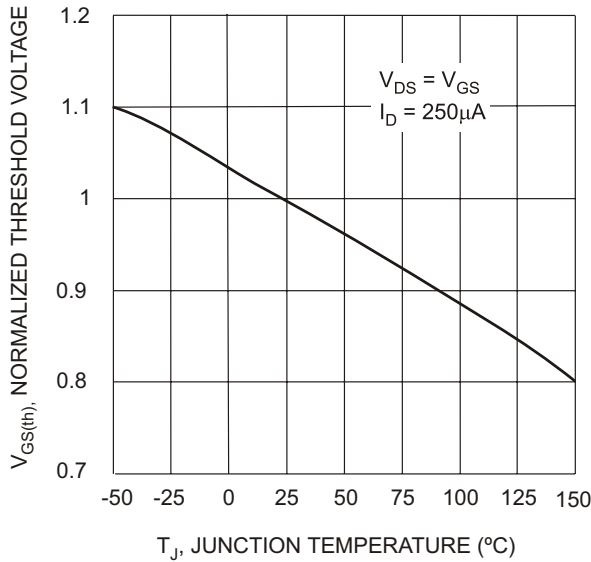

Fig. 3 Gate Threshold Variation with Temperature

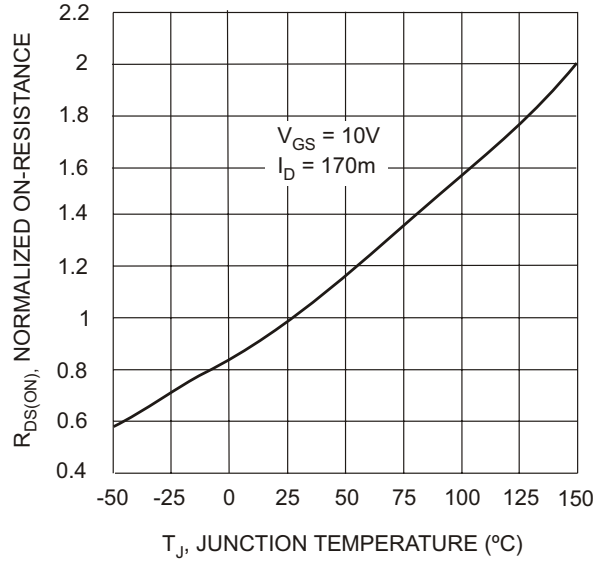

Fig. 4 On-Resistance Variation with Temperature

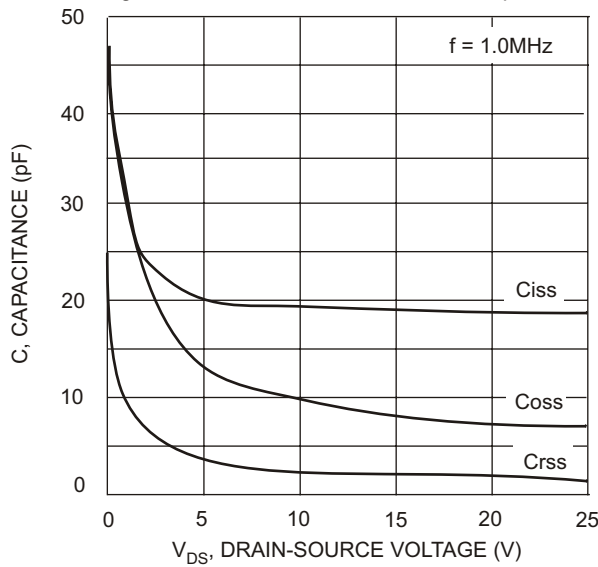

Fig. 5 Typical Capacitance

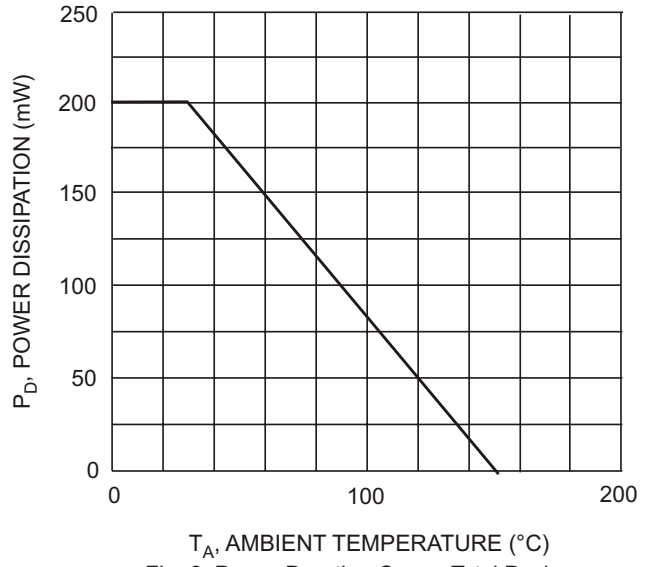

Fig. 6 Power Derating Curve, Total Package

**Ordering Information** (Note 3)

Device	Packaging	Shipping
BSS123W-7	SOT-323	3000/Tape & Reel

- Notes: 3. For Packaging Details, go to our website at <http://www.diodes.com/datasheets/ap02007.pdf>.  
 4. For Lead Free version (with Lead Free terminal finish) part number, please add "-F" suffix to part number above.  
 Example: BSS123W-7-F.

**Marking Information**

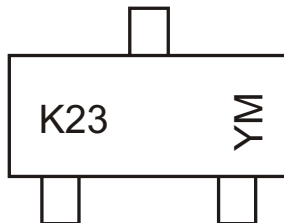

K23 = Product Type Marking Code  
 YM = Date Code Marking  
 Y = Year ex: N = 2002  
 M = Month ex: 9 = September

Date Code Key

Year	2002	2003	2004	2005	2006	2007	2008	2009
Code	N	P	R	S	T	U	V	W

Month	Jan	Feb	March	Apr	May	Jun	Jul	Aug	Sep	Oct	Nov	Dec
Code	1	2	3	4	5	6	7	8	9	O	N	D