

Schottky Barrier Diodes 30V

| V _{RM} (V) | Package | Part Number | I _F (AV) (A) | I _{FSM} (A) | T _J (°C) | T _{stg} (°C) | V _F (V) max | I _F (A) | I _R (mA) | I _R (H) (mA) | R _{th} (j-ℓ) R _{th} (j-c) (°C/W) | Mass (g) | Fig. No. | Page where characteristic curve is shown | | |
|------------------------|-----------------------------|-------------|----------------------------|--|------------------------|--------------------------|------------------------------|-----------------------|--|--|--|-------------|----------|--|------------------------|---|
| | | | | 50Hz Half-cycle Sinewave Single Shot | | | | | V _R =V _{RM} max | V _R =V _{RM} max | | | | | T _a (°C) | |
| 30 | Surface Mount | MI1A3 | 1.0 | 12 | -40 to +150 | 0.47 | 1.0 | 1 | 70 | 150 (Tj) | 70 | 0.011 | 1 | 82 | | |
| | | MI2A3 * | 1.0 | 12 | -40 to +125 | 0.39 | 1.0 | 2 | 110 | 125 (Tj) | 70 | 0.011 | | | | |
| | | SFPA-53 | 1.0 | 30 | -40 to +125 | 0.36 | 1.0 | 1.5 | 70 | 100 | 20 | 0.072 | | | 2 | — |
| | | SFPJ-53 * | 1.0 | 30 | -40 to +150 | 0.45 | 1.0 | 1.0 | 35 | 150 | 20 | 0.072 | | | | |
| | | SFPA-63 | 2.0 | 40 | -40 to +125 | 0.36 | 2.0 | 3.0 | 140 | 100 | 20 | 0.072 | | | | |
| | | SFPE-63 * | 2.0 | 40 | -40 to +150 | 0.55 | 2.0 | 0.2 | 20 | 150 (Tj) | 20 | 0.072 | | | | |
| | | SFPJ-63 | 2.0 | 40 | -40 to +150 | 0.45 | 2.0 | 2.0 | 70 | 150 | 20 | 0.072 | | | | |
| | | SFPA-73 | 3.0 | 50 | -40 to +125 | 0.36 | 3.0 | 4.5 | 210 | 100 | 20 | 0.072 | | | | |
| | | SFPJ-73 | 3.0 | 50 | -40 to +150 | 0.45 | 3.0 | 3.0 | 100 | 150 | 20 | 0.072 | | | | |
| | | SPJ-G53S | 5.0 | 100 | -40 to +150 | 0.45 | 5.0 | 5.0 | 250 | 150 | 5 | 0.29 | | | | |
| | Surface Mount Center-tap | SPJ-63S | 6.0 | 50 | -40 to +150 | 0.45 | 3.0 | 3 | 100 | 150 (Tj) | 5 | 0.29 | 3 | | | |
| | Axial | AK 03 | 1.0 | 25 | -40 to +150 | 0.55 | 1.0 | 1 | 50 | 100 (Tj) | 22 | 0.13 | 4 | 85 | | |
| | | EA 03 | 1.0 | 30 | -40 to +125 | 0.36 | 1.0 | 1.5 | 70 | 100 | 20 | 0.3 | 5 | — | | |
| | | EK 03 | 1.0 | 40 | -40 to +150 | 0.55 | 1.0 | 5 | 50 | 100 | 20 | 0.3 | 6 | 86 | | |
| | | EK 13 | 1.5 | 40 | -40 to +150 | 0.55 | 2.0 | 5 | 50 | 100 | 17 | 0.3 | 6 | 86 | | |
| | | RK 13 | 1.7 | 60 | -40 to +150 | 0.55 | 2.0 | 5 | 50 | 100 | 15 | 0.45 | 7 | 87 | | |
| | | RA 13 | 2.0 | 40 | -40 to +125 | 0.36 | 2.0 | 3 | 140 | 100 | 15 | 0.45 | 7 | — | | |
| | | RK 33 | 2.5 | 50 | -40 to +150 | 0.55 | 2.5 | 5 | 50 | 100 | 12 | 0.6 | 8 | 87 | | |
| | | RJ 43 | 3.0 | 50 | -40 to +150 | 0.45 | 3.0 | 3 | 100 | 150 | 8 | 1.2 | 9 | — | | |
| | | RK 43 | 3.0 | 80 | -40 to +150 | 0.55 | 3.0 | 5 | 50 | 100 | 8 | 1.2 | 9 | 88 | | |
| Center-tap | | FMJ-23L | 10 | 100 | -40 to +150 | 0.45 | 5.0 | 5 | 250 | 150 (Tj) | 4 | 2.1 | 10 | 93 | | |
| | FMJ-2203 | 20 | 150 | -40 to +150 | 0.47 | 10.0 | 10 | 350 | 150 | 4 | 2.1 | 10 | — | | | |
| | FMJ-2303 | 30 | 150 | -40 to +150 | 0.48 | 15.0 | 15 | 500 | 150 | 4 | 2.1 | 10 | — | | | |

External Dimensions

Flammability: UL94V-0 or Equivalent (Unit: mm)

* : Under development

1

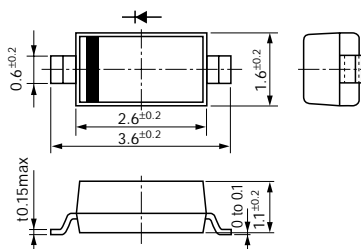

2

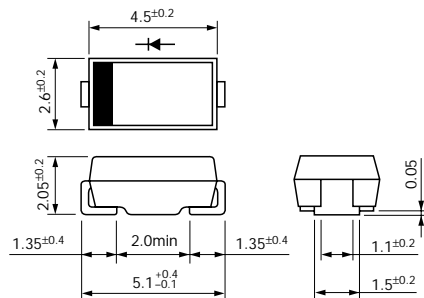

3

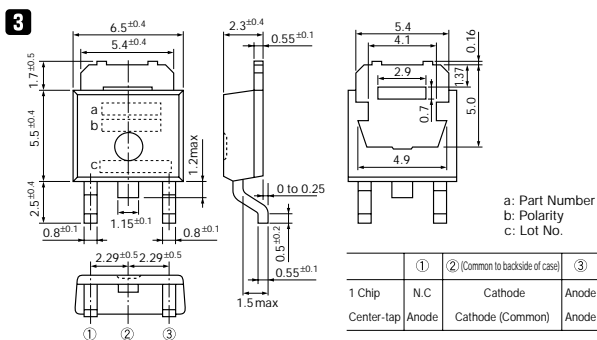

4

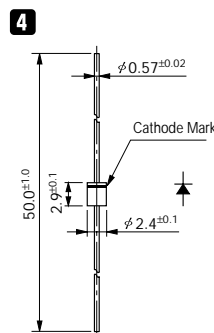

5

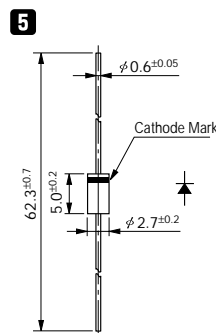

6

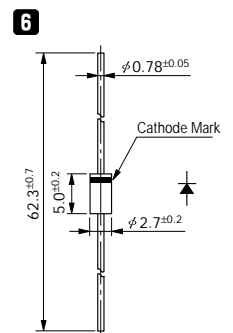

7

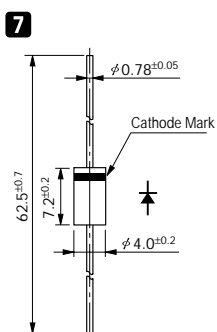

8

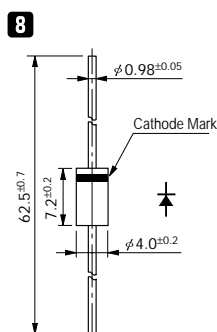

9

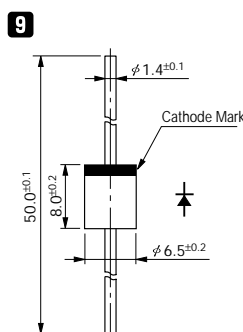

10

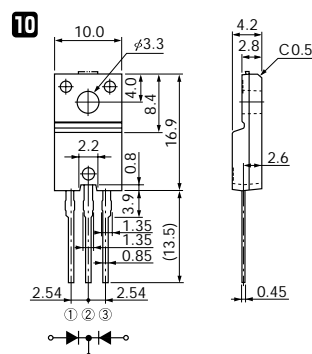

Characteristic Curves Schottky Barrier Diodes

MI1A3

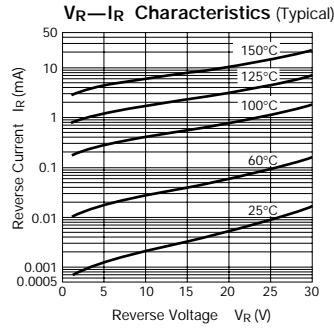
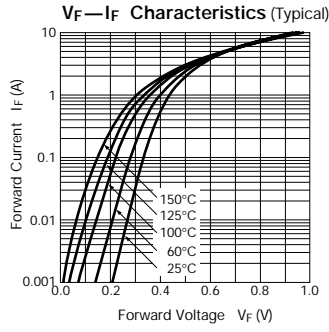
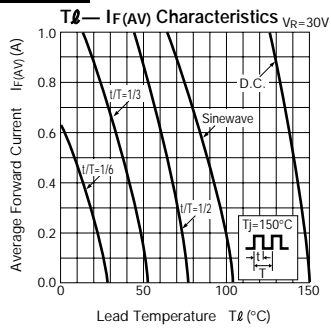

SFPB-54

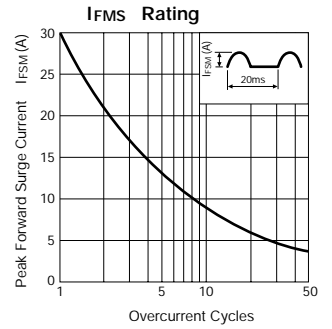
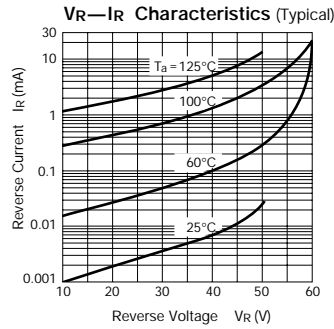
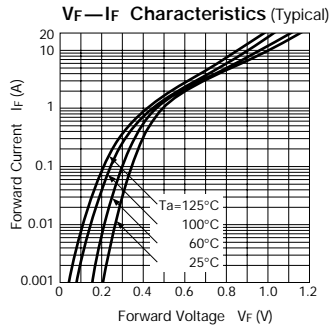
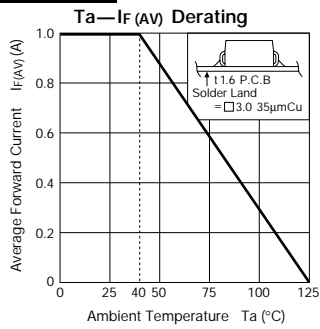

SFPB-56

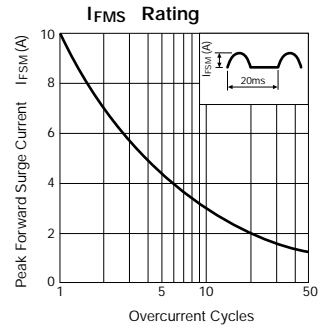
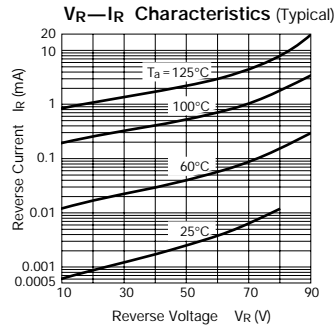
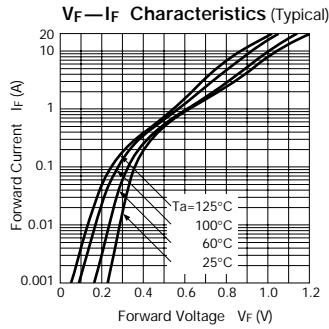
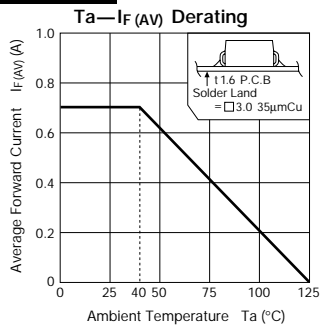

SFPB-59

