

## AM - Receiver Circuit

### Description

This is an efficient bipolar monolithic circuit to apply in battery - powered or mains - operated radio receivers up to 30 MHz. It contains controlled RF stage, mixer, separated oscillator and regulated multistage IF amplifier.

### Features

- symmetrical structured circuitry
- controlled RF prestage
- multiplicative balanced mixer, separated oscillator
- very well implemented large - signal characteristic begins already from 4.5 V supply voltage
- terminals for indicating instrument
- controlled IF amplifier implementing 60 dB control range
- external demodulator (diode)
- wide range of supply voltage between 4.5 and 15 V

### Package

TCA 440 • DIP 16

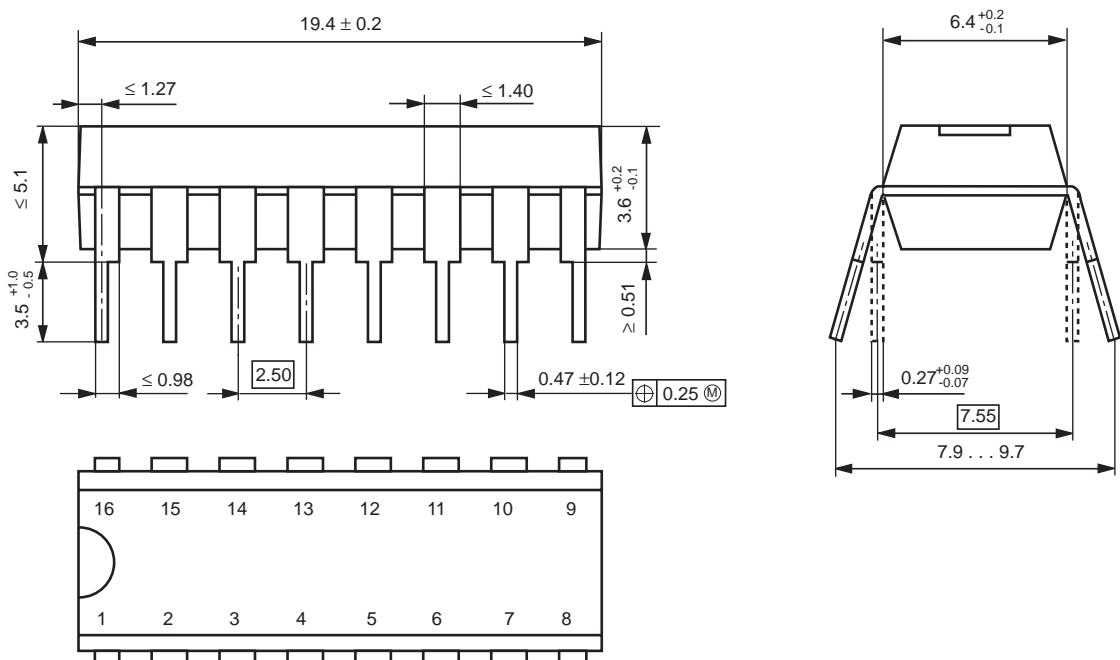

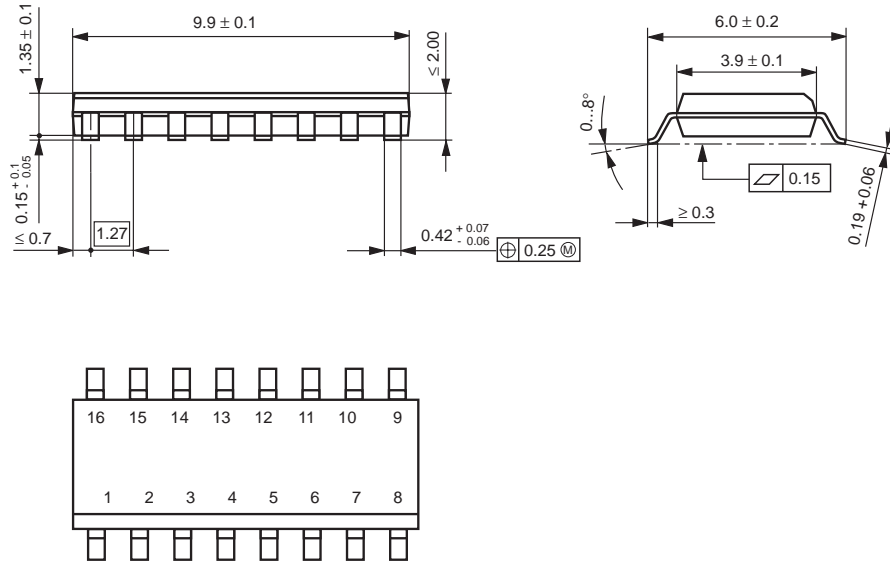

Pin configuration

1	RF prestage, input 1	9	input IF control amplifier
2	RF prestage, input 2	10	indicator output IF control amplifier
3	RF control amplifier input	11	IF blocking
4	oscillator circuit pin 1	12	input IF amplifier
5	oscillator circuit pin 2	13	IF blocking
6	oscillator circuit pin 3	14	supply voltage
7	IF output	15	mixer output 1
8	ground	16	mixer output 2

Block diagram

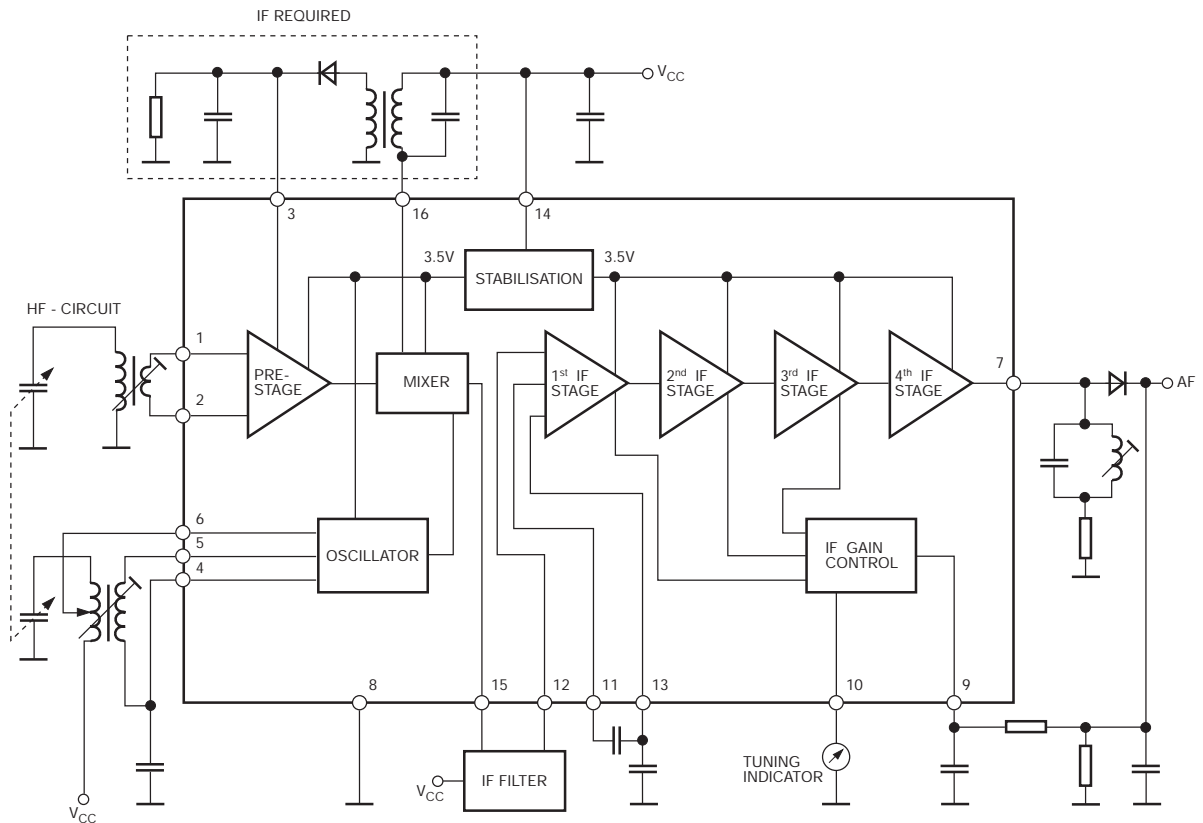

## Functional description

It contains several function units, which enable designing and assembling of efficient AM tuners. Caused by internal voltage stabilization characteristics are rather independent from supply voltage.

The RF input signal reaches via a controllable and overdriving proof preselector stage a balanced mixer. By means of a RF - signal generated by a separated oscillator the input signal is transported into IF. Multiplicative mixing causes only few harmonic content. Gain control is carried out by means of two separated feedback control loops for preselector stage and IF amplifier. By these a loop bandwidth of approximately 100 dB is obtained. The control voltage of the IF - amplifier can be used to drive a moving - coil instrument (field strength indicator). The IF amplifier consists of 4 amplifier stages, the first, second and third can be controlled. The bandwidth of the IF amplifier is approximately 2 MHz and on that account sufficient for usual IF frequencies in the AM range of approximately 460 kHz.

The symmetrical arrangement of the entire circuitry guarantees well oscillating. The bridge of the mixer avoids direct breakdown.

## Absolute maximum ratings

		min	max	unit
Supply voltage	$V_{CC}$	4.5	15.0	V
Junction temperature	$T_j$		150	°C
Ambient operating temperature	$T_a$	-15	80	°C
Storage temperature	$T_s$	-40	125	°C
Total thermal resistance	$R_{thja}$		120	K/W

## Recommended operational conditions

		min	max	unit
Supply voltage	$V_{CC}$	4.5	15	V
Ambient operating temperature	$T_a$	-10	70	°C

## Characteristics

refer to application examples,  $f_i = 1 \text{ MHz}$ ,  $f_{\text{osc}} = 1.455 \text{ kHz}$ ,  $f_{\text{IF}} = 455 \text{ kHz}$ ,  $V_{\text{CC}} = 9 \text{ V}$ ,  $f_m = 1 \text{ kHz}$ ,  $m = 0.8$ , voltages refer to ground,  $T_a = 20 \text{ to } 25 \text{ }^\circ\text{C}$ , unless specified otherwise

		min	typ	max	unit
<u>Current and voltage supply</u> (no RF signal)					
Supply voltage	$V_{14-8}$	4.5	9	15	V
Current consumption					
$V_{14-8} = 4.5 \text{ V}$	$I_{14}$		7		mA
$V_{14-8} = 9 \text{ V}$	$I_{14}$		10.5	16	mA
$V_{14-8} = 15 \text{ V}$	$I_{14}$		12		mA
<u>Entire receiver</u>					
RF level variation					
with $\Delta V_{\text{NF}} = 6 \text{ dB}$	$\Delta V_{\text{RF}}$		65		dB
with $\Delta V_{\text{NF}} = 10 \text{ dB}$	$\Delta V_{\text{RF}}$		80		dB
NF output voltages (symmetrically measured at 1-2)					
$V_{\text{iHF}} = 20 \text{ } \mu\text{V}$ , $m = 0.8$	$V_{\text{NF(rms)}}$	60	140		mV
$V_{\text{iHF}} = 1 \text{ mV}$ , $m = 0.8$	$V_{\text{NF(rms)}}$		260		mV
$V_{\text{iHF}} = 500 \text{ mV}$ , $m = 0.8$	$V_{\text{NF(rms)}}$	100	350	560	mV
$V_{\text{iHF}} = 20 \text{ } \mu\text{V}$ , $m = 0.3$	$V_{\text{NF(rms)}}$		50		mV
$V_{\text{iHF}} = 1 \text{ mV}$ , $m = 0.3$	$V_{\text{NF(rms)}}$		100		mV
$V_{\text{iHF}} = 500 \text{ mV}$ , $m = 0.3$	$V_{\text{NF(rms)}}$		130		mV
RF input sensitivity measured at $60 \text{ } \Omega$ , $m = 0.3$ , $R_G = 540 \text{ } \Omega$					
signal-to-noise ratio					
$S + N/N = 6 \text{ dB}$	$V_{\text{iRF}}$		1		$\mu\text{V}$
$S + N/N = 26 \text{ dB}$	$V_{\text{iRF}}$		7		$\mu\text{V}$
$S + N/N = 58 \text{ dB}$	$V_{\text{iRF}}$		1		mV
Maximum RF input voltage (THD = 10 %)	$V_{\text{iHF}}$			1.5	V
Total harmonic distortion					
$V_{\text{HF}} = 500 \text{ mV}$	THD		4.5	10	%
$V_{\text{HF}} = 30 \text{ mV}$	THD		2.8	8	%
<u>RF part</u>					
Input frequency range	$f_{\text{iHF}}$	0		50	MHz
Output frequency					
$f_{\text{IF}} = f_{\text{osc}} - f_{\text{iHF}}$	$f_{\text{IF}}$		455		kHz
Control range	$\Delta G_V$		38		dB

		min	typ	max	unit
IF suppression between 1 - 2 and 15	$a_{IF}$		20		dB
RF input impedance unbalanced coupling					
$V_{iHFmax}$	$Z_i$		2    5		k $\Omega$   pF
$V_{iHFmin}$	$Z_i$		2.2    1.5		k $\Omega$   pF
balanced coupling					
$V_{iHFmax}$	$Z_i$		4.5		k $\Omega$
$V_{iHFmin}$	$Z_i$		4.5    1.5		k $\Omega$   pF
Mixer output impedance (pin 15 or 16)	$Z_o$		250    4.5		k $\Omega$   pF
Steepness	$S_{HF}$		28		mS
<u>IF part</u>					
Input frequency range	$f_{iIF}$	0		2	MHz
Control range $f_{iIF} = 455$ kHz, $\Delta V_{NF} = 10$ dB	$\Delta G_V$		62		dB
Start of control ( $\Delta V_{iIF} / \Delta V_{NF} = 10$ dB / 3 dB)	$V_{ctrlIF}$		140		$\mu$ V
maximum IF input voltage ( $THD_{NF} = 10$ %)	$V_{iIFmax}$		200		mV
NF output voltage applied to 60 $\Omega$					
$V_{ZF} = 30$ $\mu$ V	$V_{NF(rms)}$		50		mV
$V_{ZF} = 3$ mV	$V_{NF(rms)}$		200		mV
$V_{ZF} = 3$ mV; $m = 0.3$	$V_{NF(rms)}$		70		mV
IF input impedance (unbalanced coupling)	$Z_{iIF}$		3    3		k $\Omega$   pF
IF output impedance (pin 7)	$Z_o$		200    8		k $\Omega$   pF

## Indication instrument

Recommended indication instruments: 500  $\mu$ A ( $R_i = 800$   $\Omega$ )  
300  $\mu$ A ( $R_i = 1.5$  k $\Omega$ )

For indication a voltage source of 600 mV ( $V_{EMF}$ ) and an internal source impedance of 400  $\Omega$  is available.

# Dependences

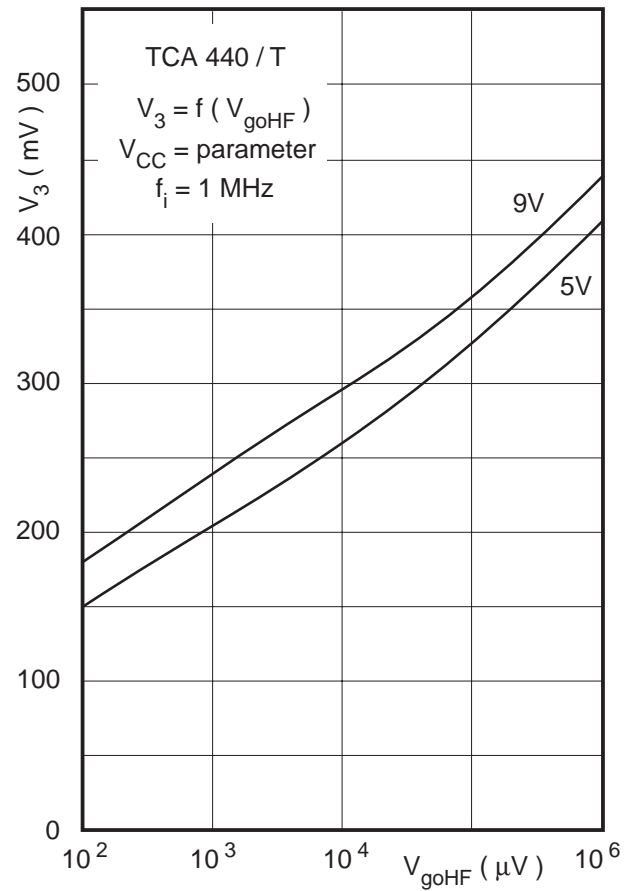
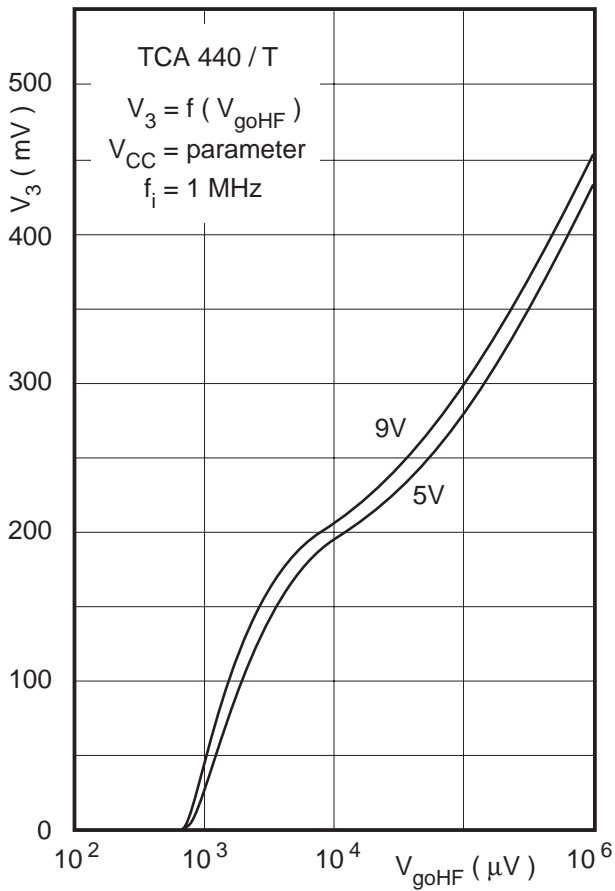
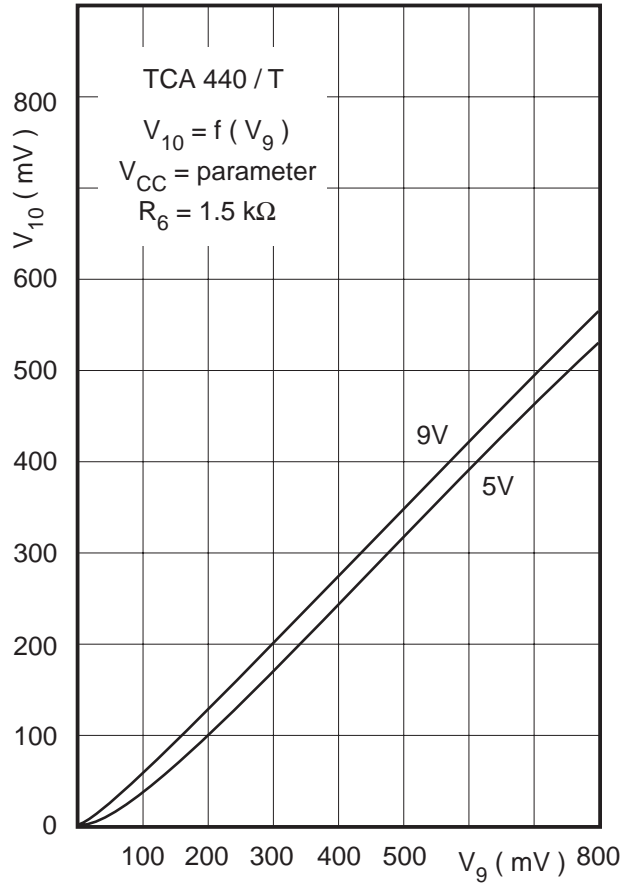
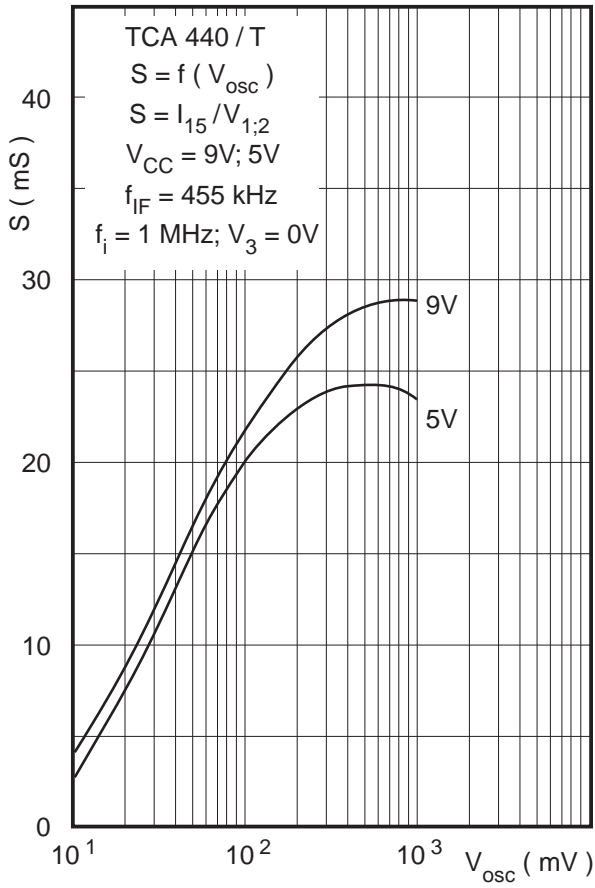

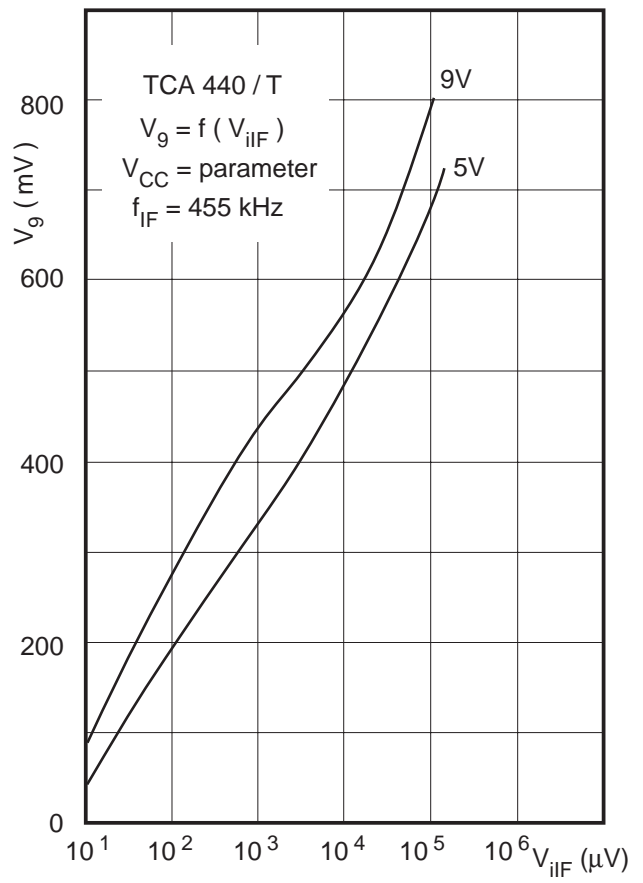
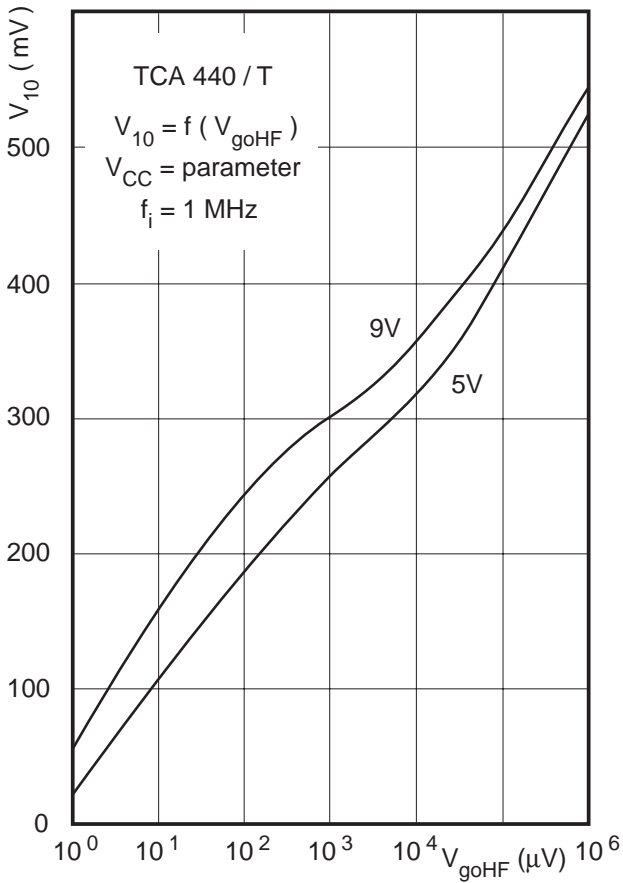
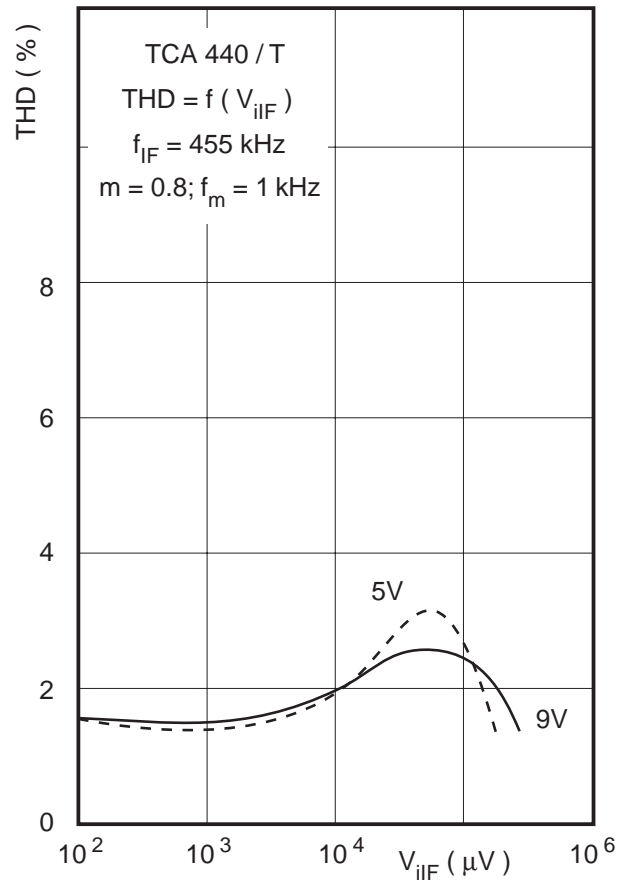
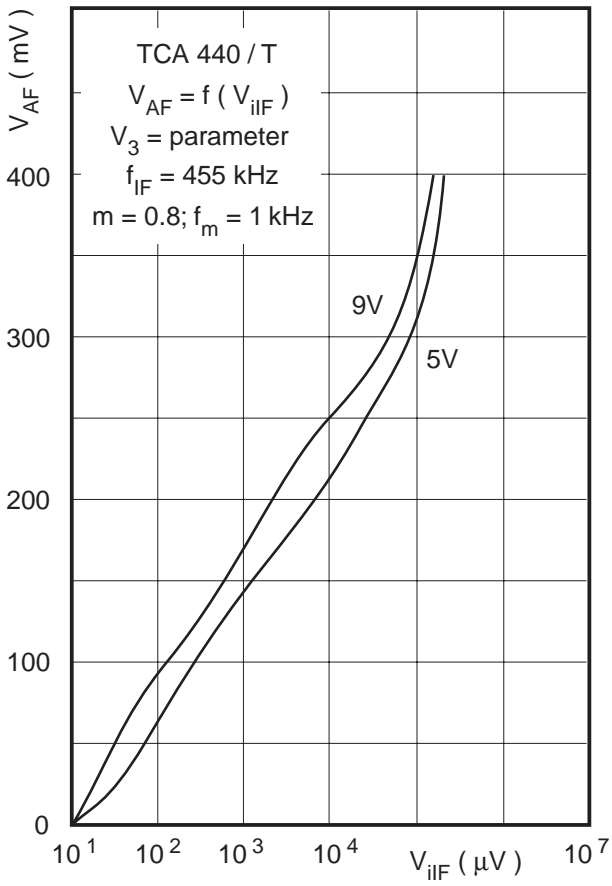

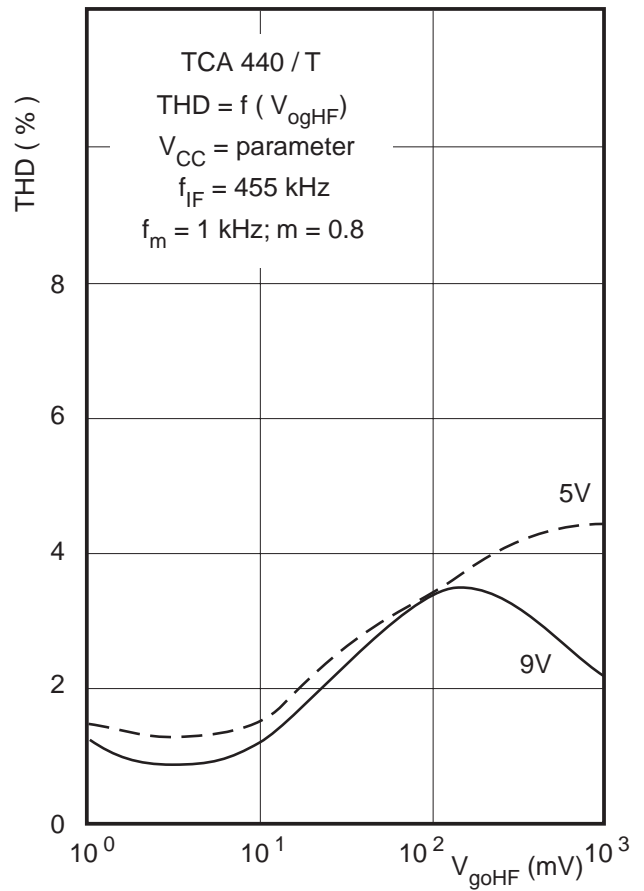
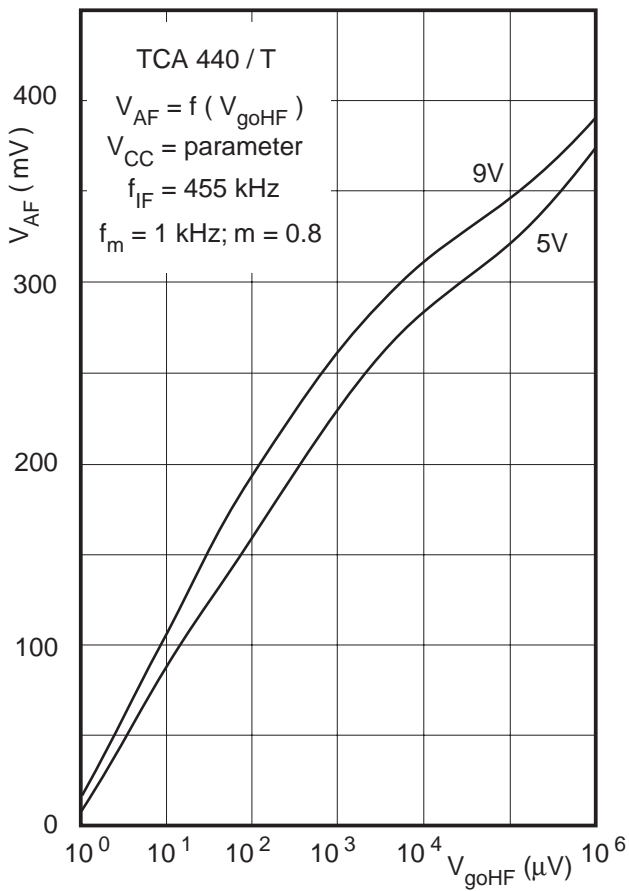
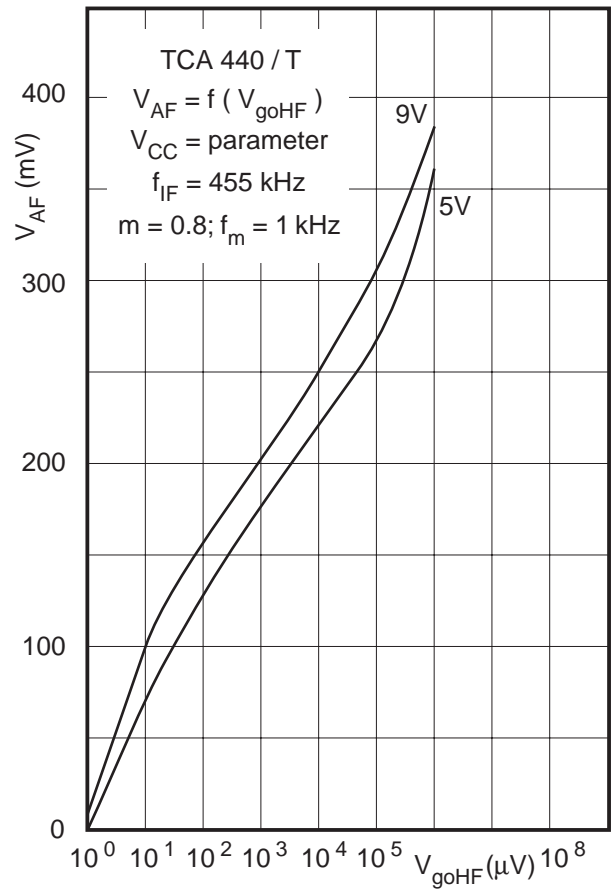
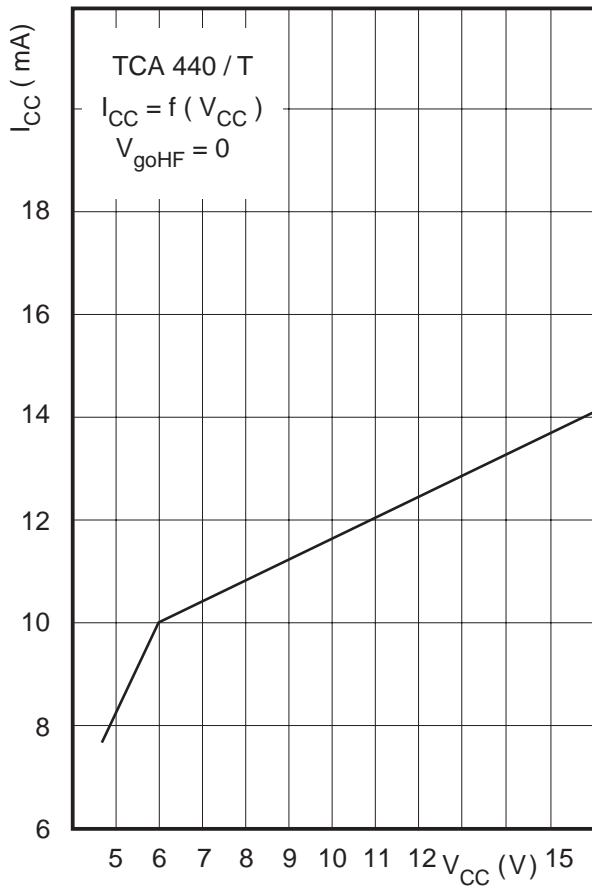



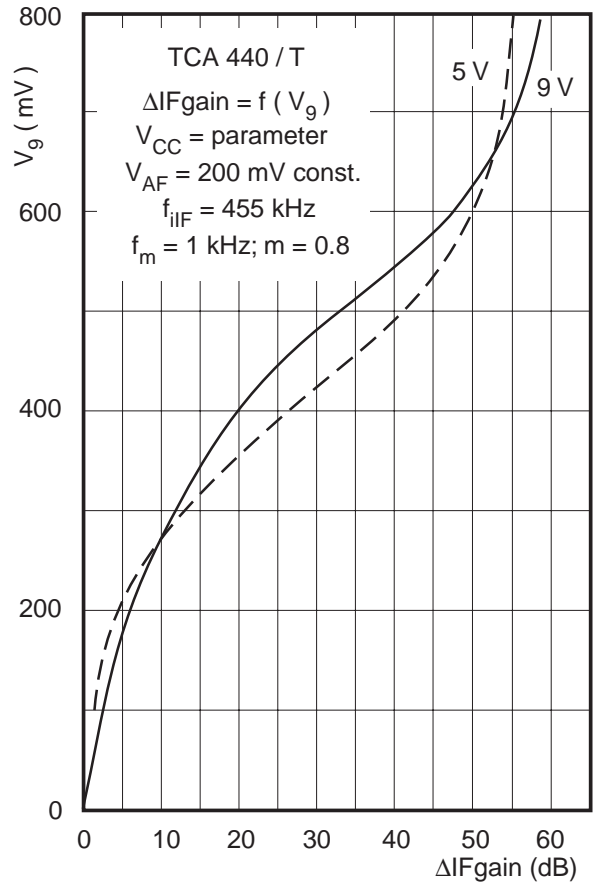
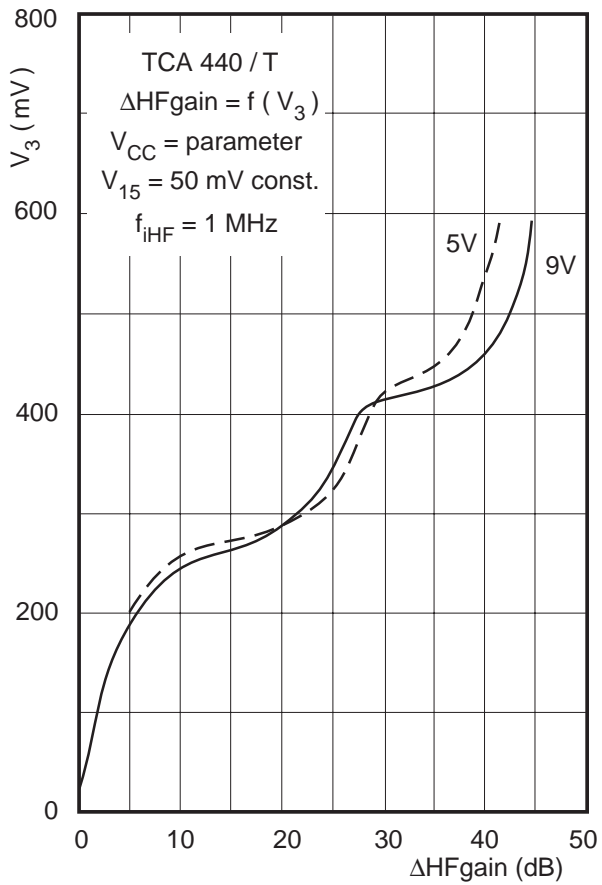
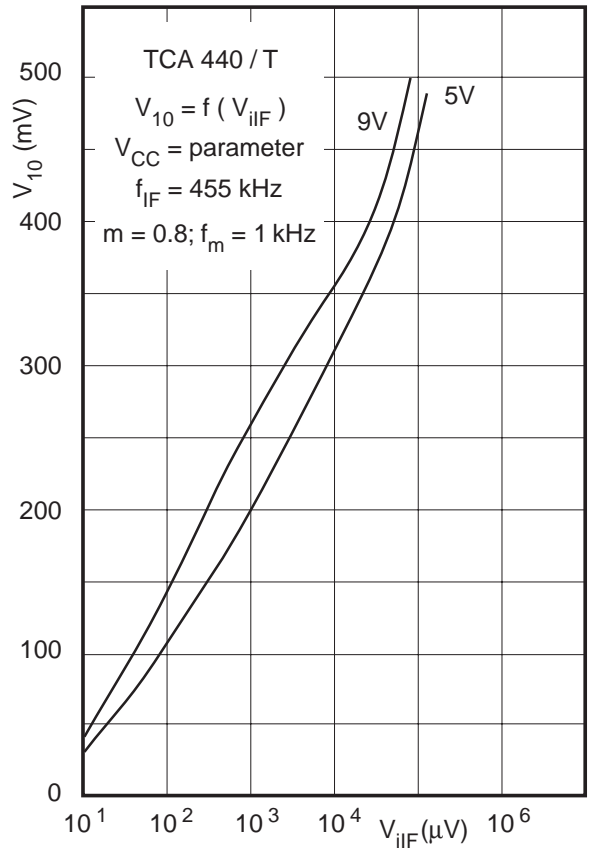
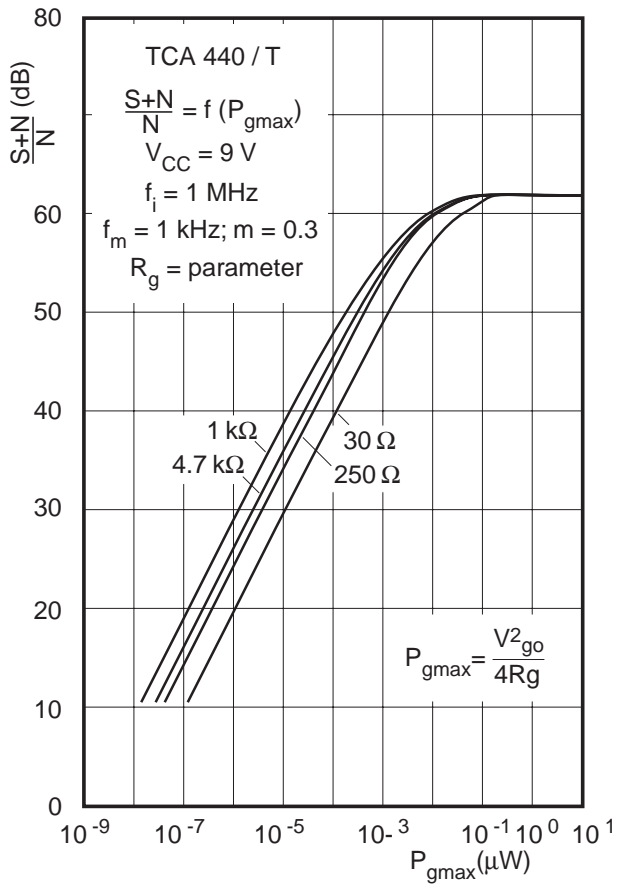

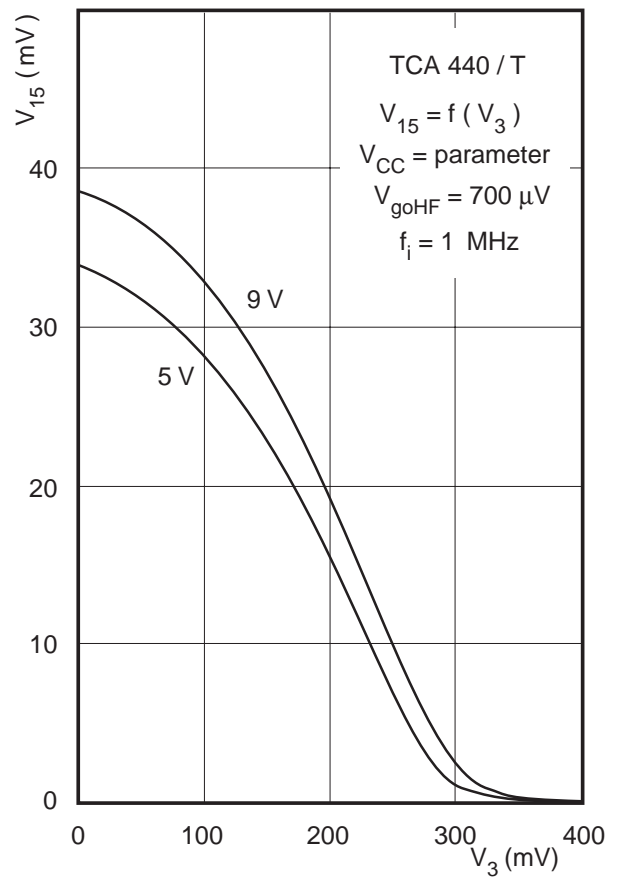
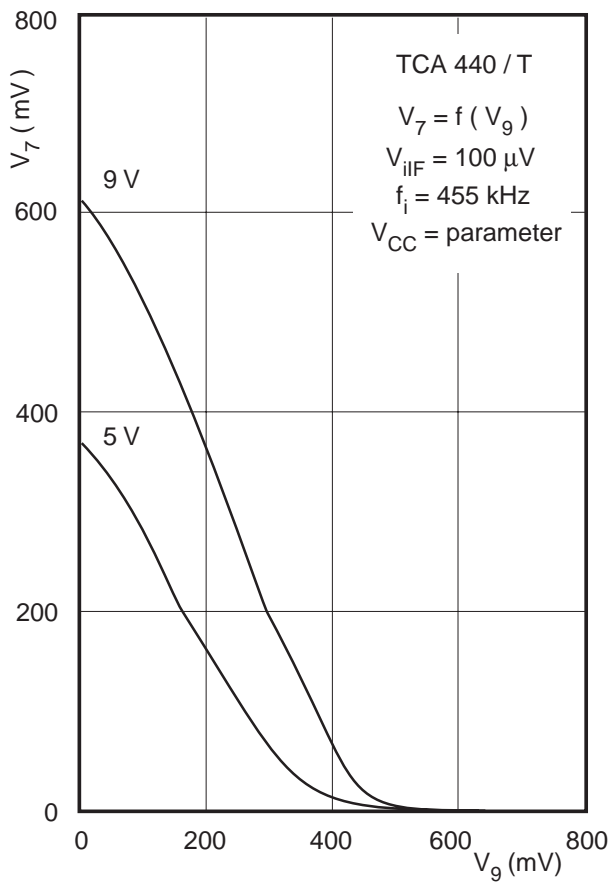

### Application examples

- TCA 440

